



9' x 9' Muskoka Cabin Assembly Manual

Version #1.3
May 12, 2022

Thank you for purchasing a 9x9 Muskoka Cabin. Please take the time to identify all the parts prior to assembly.

Safety Points and Other Considerations

Our products are built for use based on proper installation on level ground and normal residential use. Please follow the instruction manual when building your shed and retain the manual for future maintenance purposes.

Customers are responsible for ensuring a solid, level, well-draining site for construction.

Please check with your local municipal or county by-laws before ordering this product to confirm it complies with building codes.



- Snow load ratings vary by geographical location. If heavy or wet snowfall occurs, it is advisable to sweep snow off roof frequently.
- If the product is elevated, any structural and building code requirements are solely the customer's responsibility, and should be abided by.
- In areas with high or gusty wind conditions, it is advisable to install the structure securely to the ground.
- Have a regular maintenance plan to ensure screws, doors, windows and parts are tightly affixed.

Customer agrees to hold Outdoor Living Today and any Authorized Dealers free of any liability for improper installation, maintenance and repair.

In the event of a missing or broken piece, call the Outdoor Living Today Customer Support Line @ 1-888-658-1658 within 30 days of the delivery of your purchase. It is our commitment to you to courier replacement parts, free of charge, within 10 business days of this notification. Replacement parts will not be provided free of charge after the 30 day grace period.

All structures purchased from Outdoor Living Today are covered for a period of one year for defects in manufacturing and workmanship. Costs incurred for customer installations are not included.

Failure to use supplied parts included in this kit could result in poor product performance and may void your warranty. Please contact Outdoor Living Today's Customer Toll Free Line if you plan to deviate from our written instructions.

What to do before my Shed arrives?



- Become familiar with this assembly manual and determine if you can complete the project yourself or will require a professional contractor.



- One helper is recommended to assist in constructing your shed. It generally takes two people about 3 days to assemble a shed. If you're hiring a contractor, their rate should be in line with that duration of work.



- Clear the construction area and ensure a clear pathway for delivery when the freight company arrives. Remove all debris: roots, grass, rocks, etc.



- Excavate the site. Contact your local utilities company to ensure there are no gas or electric lines buried in the area before digging.



- Decide on the type of foundation you will be using:
 - Concrete slab, or
 - 4-6 inches of crushed gravel with paver stones or 4x4 stringers.

You can find the footprint for your shed on Page 3 of your Assembly Manual.



- If doing the assembly yourself, have all the necessary tools ready to go and in working condition. A list of required tools can be found after the parts list.

Foundation Types for 10x10 Muskoka Cabin

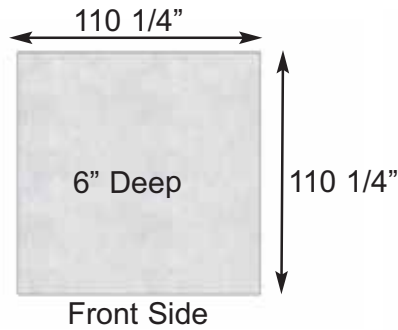

Front Side
Concrete Foundation

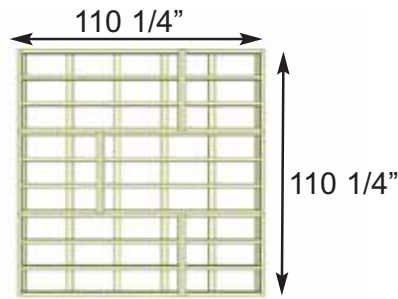

Front Side
Floor Frame

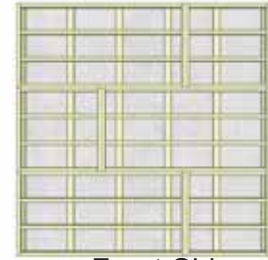

Front Side
Completed Foundation

Concrete Slab Foundation:

- Slab must be at least the same size as assembled floor frame (110 1/4" x 110 1/4") or larger.
- 6" Deep foundation.
- 1.75 Cubic Yards of concrete required.
- A concrete slab will have the longest durability out of your foundation options.

Once level, a concrete slab is the easiest surface to build on.

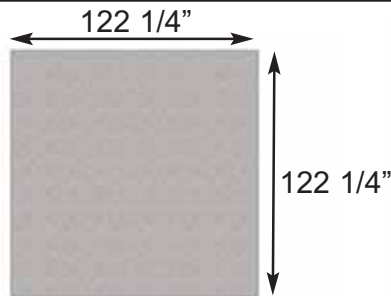

Front Side
Gravel Foundation

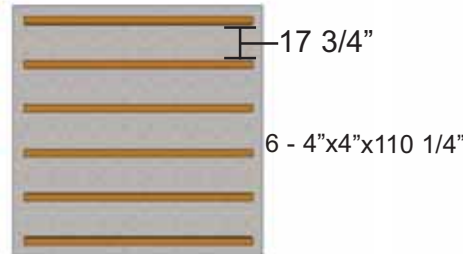

Front Side
Gravel Foundation with treated stringers

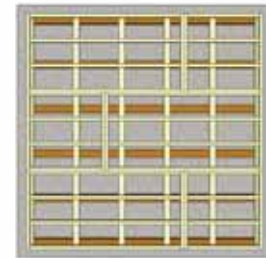

Front Side
Completed Foundation

Gravel with 4x4 Pressure Treated Stringers:

- Excavate at least 6" deep, and 6" wider than floor frame on each side.
- 2.0 Cubic Yards of gravel required, approximately 18 wheelbarrows.
- 6 - 4x4 Pressure Treated Stringers 12' long required.
- Evenly spaced, with one at each end of floor frame.

Saves money on materials, easy to level and work with.

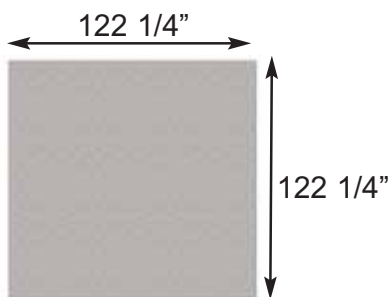

Front Side
Gravel Foundation



Front Side
Gravel Foundation with Patio Pavers

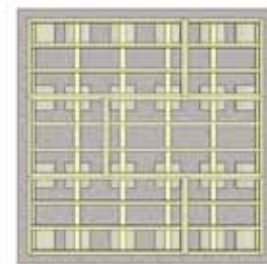

















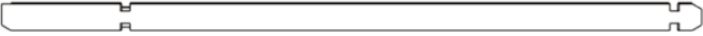

Front Side
Completed Foundation

Gravel with Patio Paver Stones:

- Excavate at least 6" deep, and 6" wider than floor frame on each side.
- 2.0 Cubic Yards of gravel required, approximately 18 wheelbarrows.
- 24 patio pavers (8" x 8" or larger).
- Center patio paver stones underneath floor runners and underneath seams in floor joists.

Patio paver stones are widely available from most landscape stores.

**Thank you for purchasing our 10 x 10 Muskoka Cabin.
Please take the time to identify all the parts prior to assembly.**

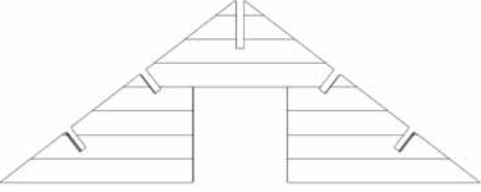
No	Details	Length	Quantity
1		118 1/8"	2
2		149 5/8"	2
3		149 5/8"	2
4		149 5/8"	2
5		149 5/8"	2
6		143 5/16"	2
7		137"	2
8		118 1/8"	38
9		118 1/8"	1
10		54 1/2"	2
11		48 1/2"	2
12		41 7/8"	20
13		15 3/4"	28
14		10 1/4"	28
s1		149 5/8"	1
s2		149 5/8"	1
s3		149 5/8"	4
b1		118 1/8"	2
f1		116 1/2"	2
g1	 Triangular Gable (Ships as 3 separate pieces)		2

Note: you may find the detailed drawings at the end of the manual.

No	Details	Length	Quantity
15	Front Wind Flap 5/8" x 3 3/8"	78 3/4"	4
16	Top Wind Flap 5/8" x 3 3/8"	78 3/4"	4
17	Side Wind Flap 5/8" x 1 3/4"	149 5/8"	2
18	Flashing Rhomb (Detail plate)		2
19	Railing 3/4" x 4 3/8"	33 1/2"	2
20	Railing 3/4" x 4 3/8"	20 5/8"	4
21	Lath 1 3/16" x 1 3/4"	106 1/4"	2
22	Ladder Components		8
23	Floor Runners 1 1/2" x 3 1/2"	39" & 71"	6 each
24	Floor Boards (Main Floor) 1 1/8" x 5 1/8"	106 1/4"	21
25	Floor Boards (Loft) 1 1/8" x 5 1/8"	63"	21
26	Roof Boards 5/8" x 5 1/8"	76 3/4"	30
27	Roof Boards 5/8" x 5 1/8"	76 3/4"	30
28	Door 33" x 74 1/4"		1
29	Window (Side Walls) 34 1/4" x 30 1/4"		2
30	Window (Front Walls) 16 1/2" x 74 1/4"		2
31	Window (Loft) 20 1/2" x 20 1/2"		2
32	Metal Roof Panels 39 1/2" x 81"		10
33	Metal Ridge Cap	60"	3
34	Foam Enclosures	24"	24
35	Floor Frame Small 36 3/4" x 36 3/4"		3
36	Floor Frame Large 73 1/2" x 36 3/4"		3
37	Floor Joist Small 1 1/2" x 3 1/2"	33 13/16"	6
38	Floor Joist Large 1 1/2" x 3 1/2"	70 7/16"	6
39	Floor Plywood 5/8" x 36 3/4"	73 1/2"	3
40	Floor Plywood 5/8" x 36 3/4"	36 3/4"	3
41	Side Window Filler Strip 3/4" x 1 1/2"	34"	2
42	Side Window Trim Bundle		2
43	Side Window Interior Trim Bundle		2
44	Loft Window Trim Bundle		2
45	Loft Window Interior Trim Bundle		2
46	Ledger Strips 1 1/2" x 1 1/2"	53"	4
47	Facia Strips 3/4" x 1 1/2"	65"	4

MUSKOKA 9x9 HARDWARE PACKAGE

BR1 - Square Drive Bit  x 1

N1 - 1 1/2" Finishing Nails  x 210

S4 - 3" Screws  x 175

S1 - 2 1/2" Screws  x 105

S3 - 2" Screws  x 125

S2 - 1 1/4" Screws  x 395

 x 2
Mallet Block

1/4"x 2"  x 80
Metal Roof Screw

 x 1
1/4" Nut Driver

 x 3
Silicon Caulking

Tools Required (Not Provided)



Utility Knife



Pliers



Hammer



Screw Gun/Drill



Tape Measure



Level



Wood Clamp



Rubber Mallet



Ladder



1/8" Drill Bit

Safety Equipment Required

(Not Provided)



Safety Glasses



Work Gloves

Helpful Tips for Assembly

- Screw through notches
- Mallet and block to pound in T&G of wall pieces
- Use a bar clamp to guide twisted pieces into place
- Optional 6" deck screws for center of boards if needed
- Some boards are not ID numbered but are identifiable by size in parts list

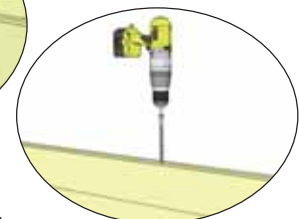
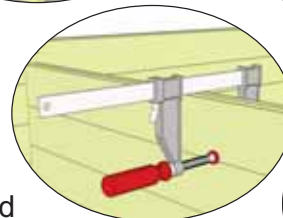
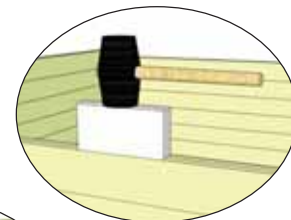
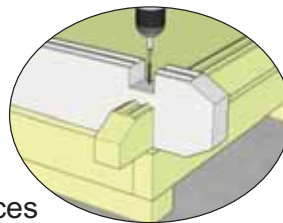

1. Floor Section

Exploded view of all parts necessary to complete Floor Section. Identify all parts prior to starting. Note: Floor Footprint is 110 1/4" wide x 110 1/4" deep.

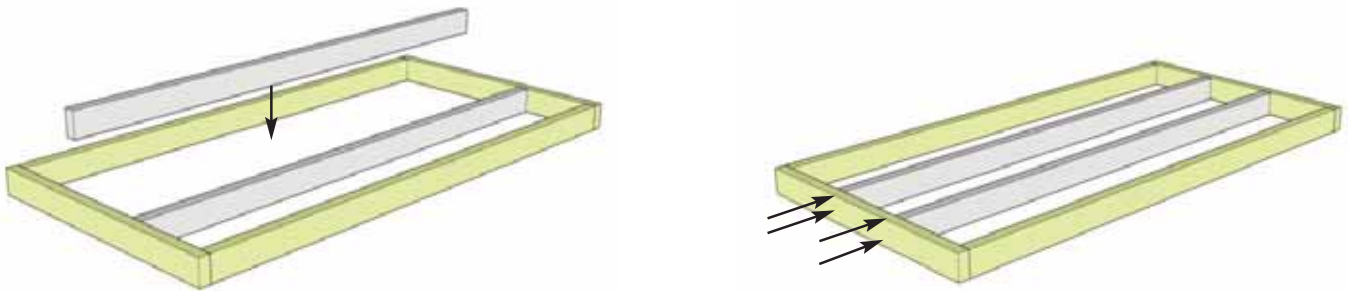
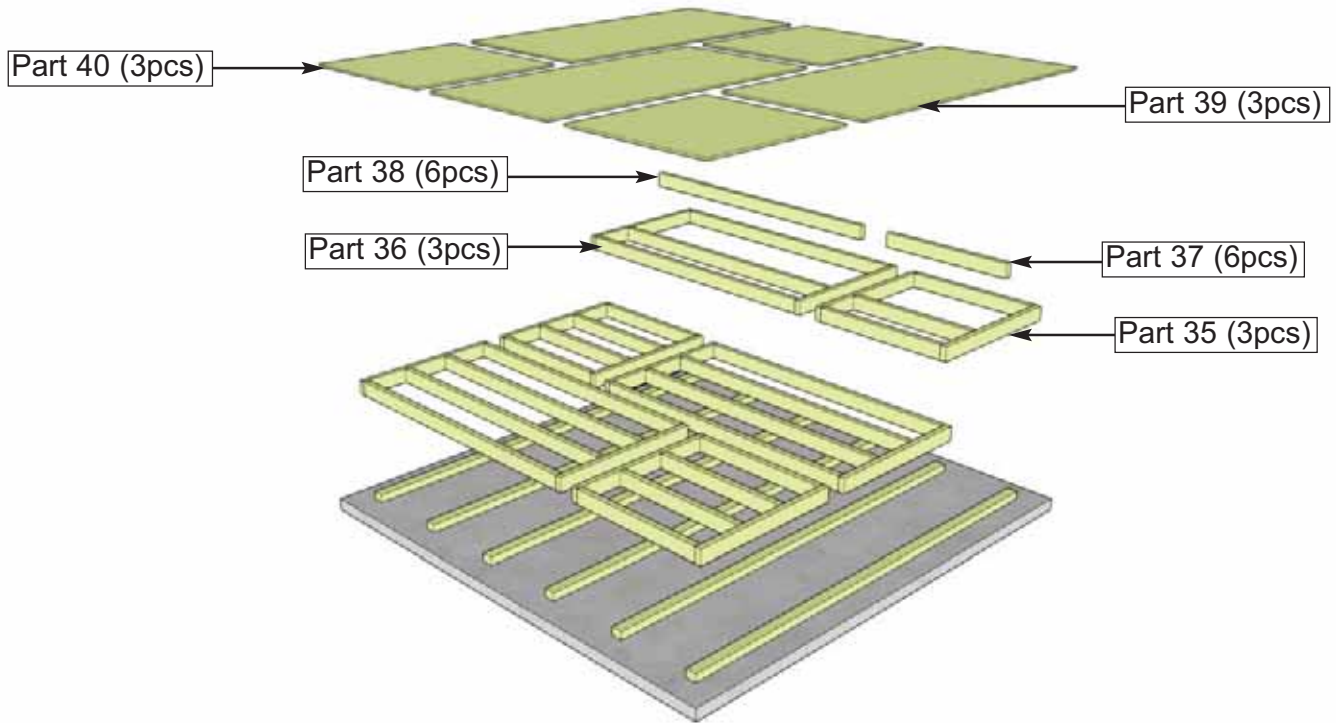

1. Lay out **Part 36 - Floor Frame** and two **Part 38 - Floor Joists** as illustrated above. Position Joists so they are spaced equally in Floor Frame and flush with framing. When correctly positioned, attach each Joist with **4 - 2 1/2" Screws** (2 per end). **You can find the Square Drive Screw Bit in the Hardware Kit Bag.** Complete remaining Floor Frame the same.

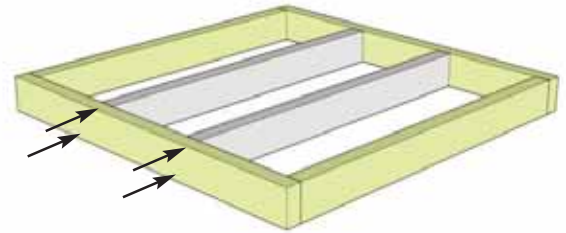
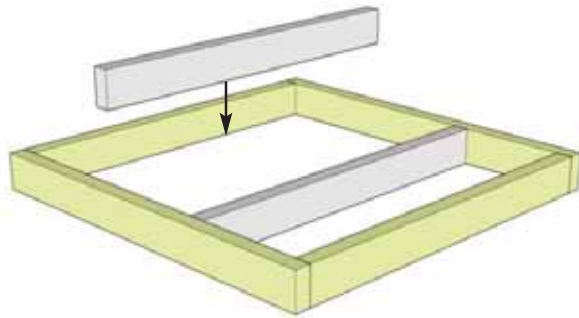

2 . Lay out **Part 35 - Floor Frame** and two **Part 37 - Floor Joists** as illustrated above and assemble as per **Step 1**. Complete each frame.

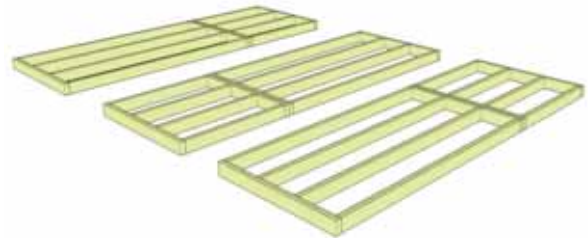
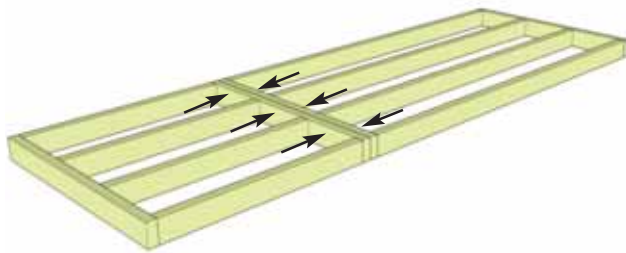

3 . Screw Frames 35 & 36 together with **6 - 2 1/2" screws**. Complete 3 sets of floor frames

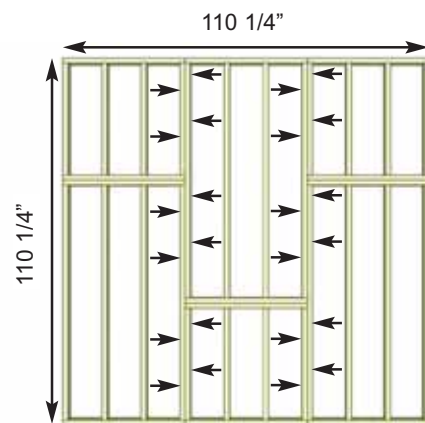
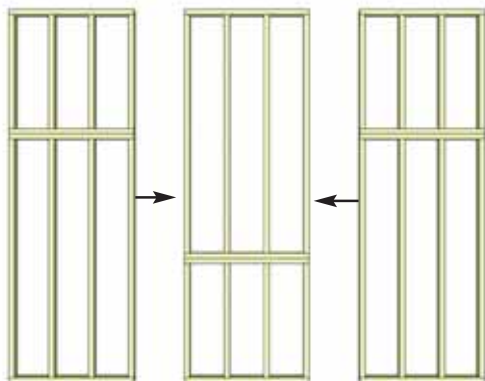

4 . Screw each set of floor frames together with **24 - 2 1/2" screws**. Have the middle floor running the opposite direction as the outside one as illustrated.

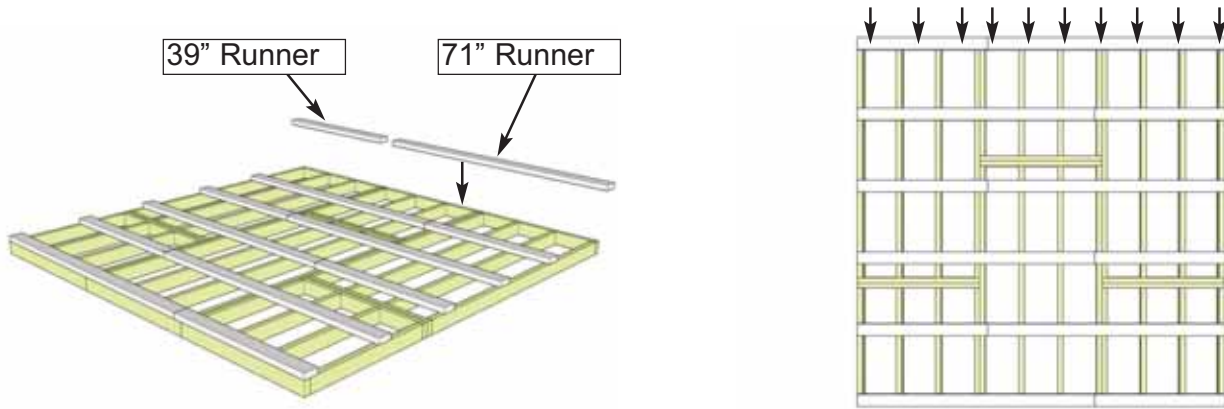

5. Locate **Parts 23 - Floor Runners** (12 Total). Place two on each edge of floor frame and evenly space remaining 8. Run floor runners perpendicular to floor joists. Floor runners should be approximately 18 3/4" apart Fasten each runner with **10 - 3" screws**.

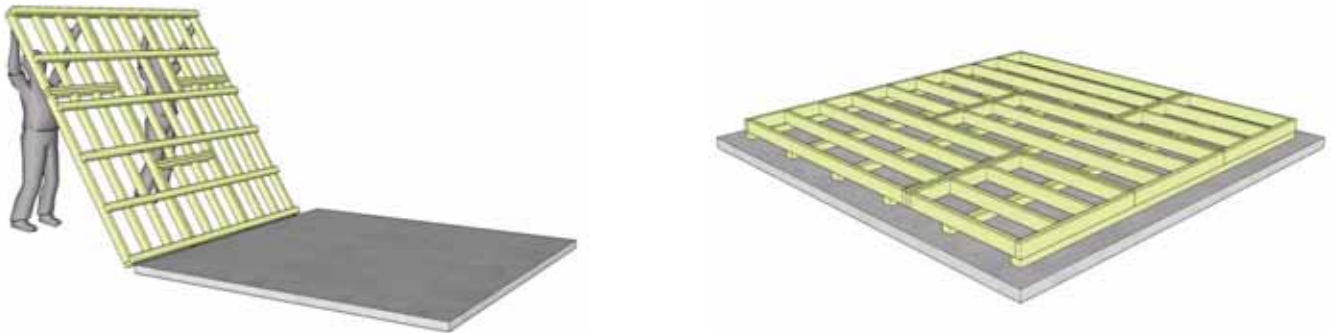

6. With floor runners attached to floor frame, carefully flip the floor over and place on to your foundation. Caution, be careful when laying floor down not to bend or twist floor. Having a level foundation is critical (see page 3 for foundation help).

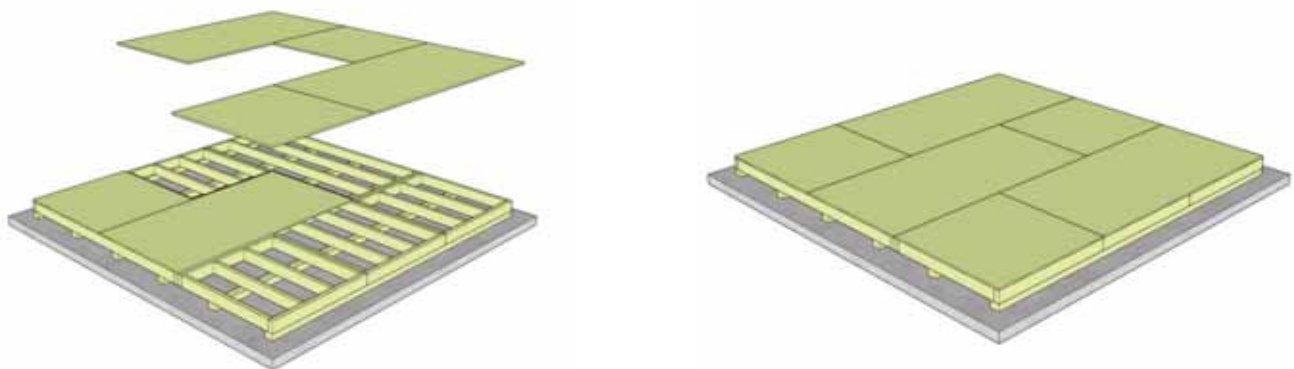

7. Locate **Parts 39 & 40 - Floor Plywood** and position on top of completed floor joists. Ensure Plywood Floor panels are positioned as above perpendicular to floor joists. Keep plywood seams tight.

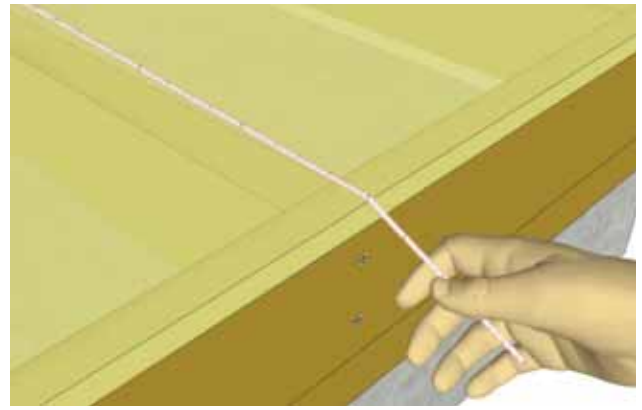
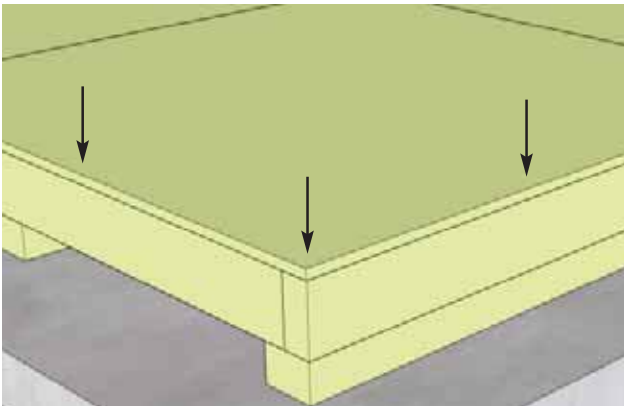

8. With Plywood in position on floor framing, attach with **1 1/4" screws** every 16" (Approximately 75 Total). **Hint:** Use a chalk line to mark location of floor joists for easy screw placement.

2. Lower Wall Section

Exploded view of all parts necessary to complete the Wall Section. Identify all parts prior to starting.

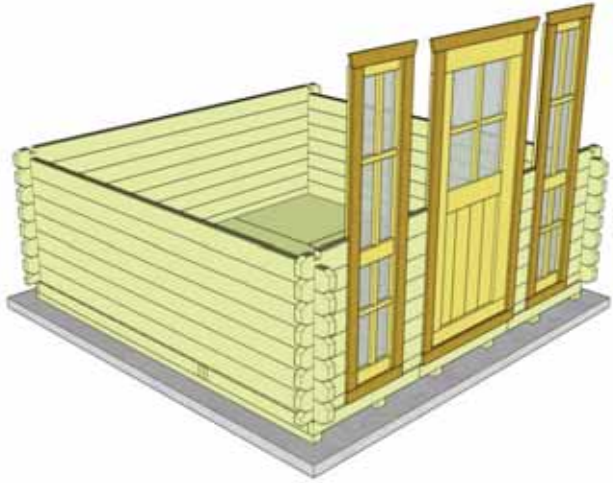
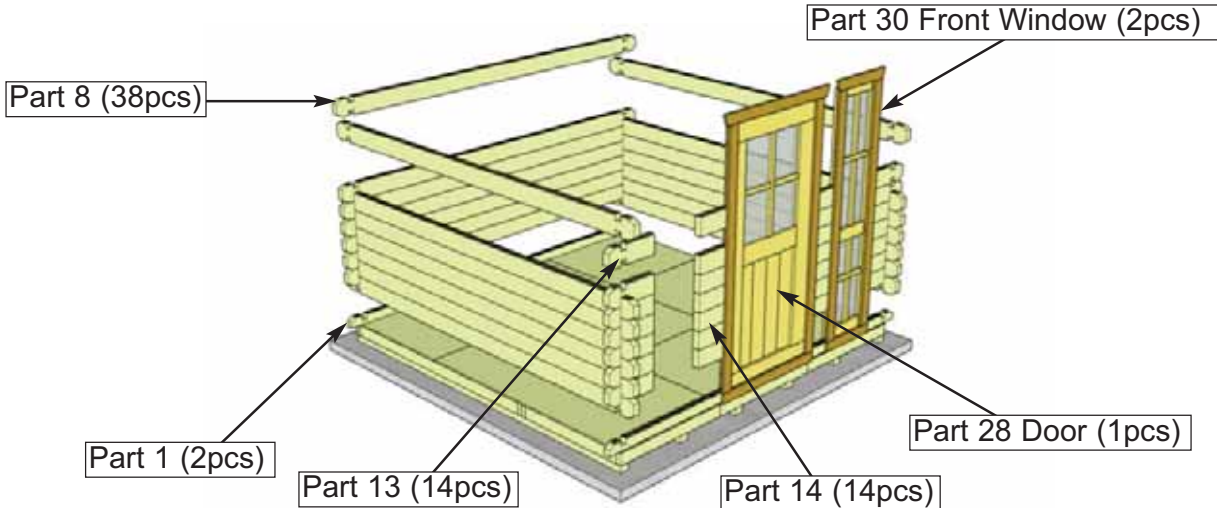

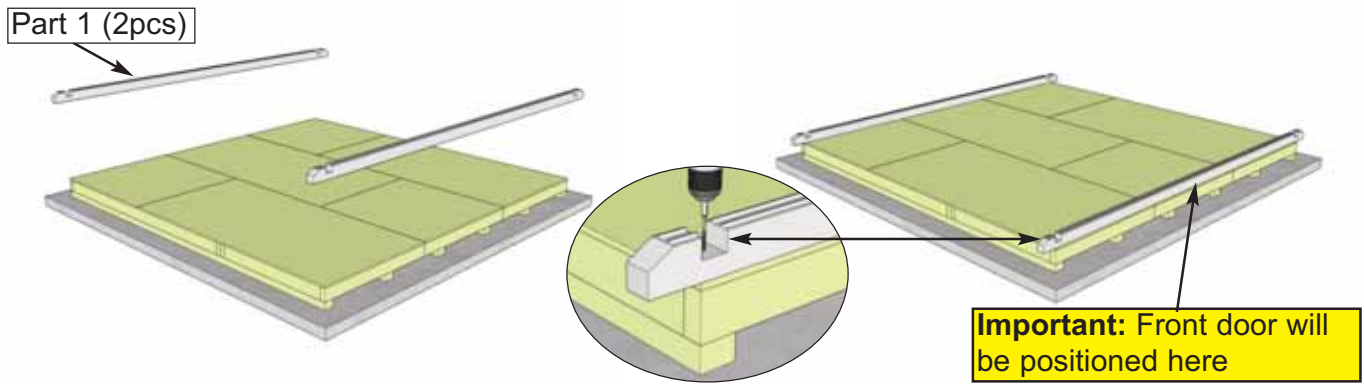

9. Locate **Parts 1** (2 Total). Place one on each edge of floor frame. Use 2 **Part 8**'s from **Step 10** to ensure starter pieces are spaced correctly. Once positioned secure **Part 1**'s to floor using **1 - 3"** screw in each end (4 total).

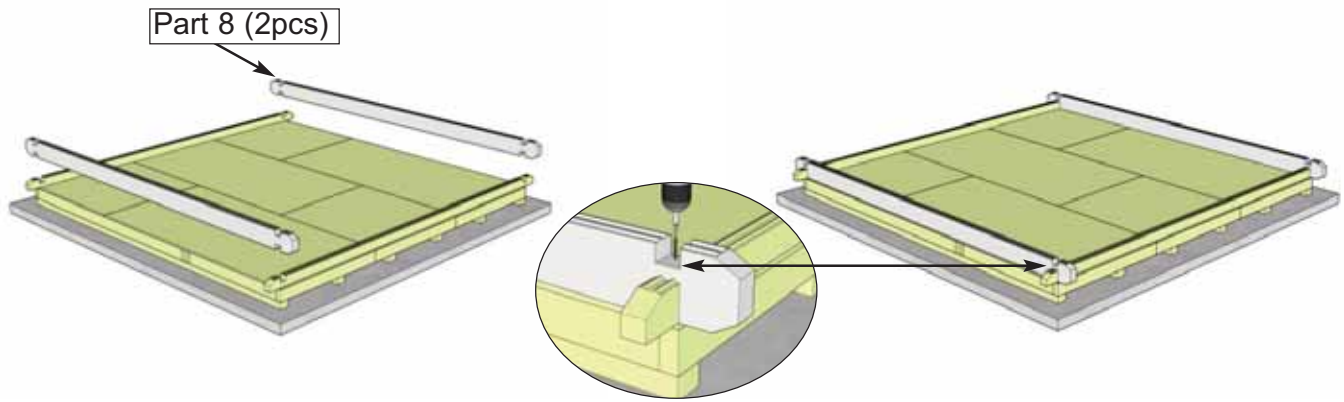

10. Locate **Part 8** (2 Total). Place one on each edge of floor frame and interlock in the notch of **Part 1**. Fasten each **Part 8** with **2 - 3"** screws, one in each end. Each board will be fastened this way as you build your structure.

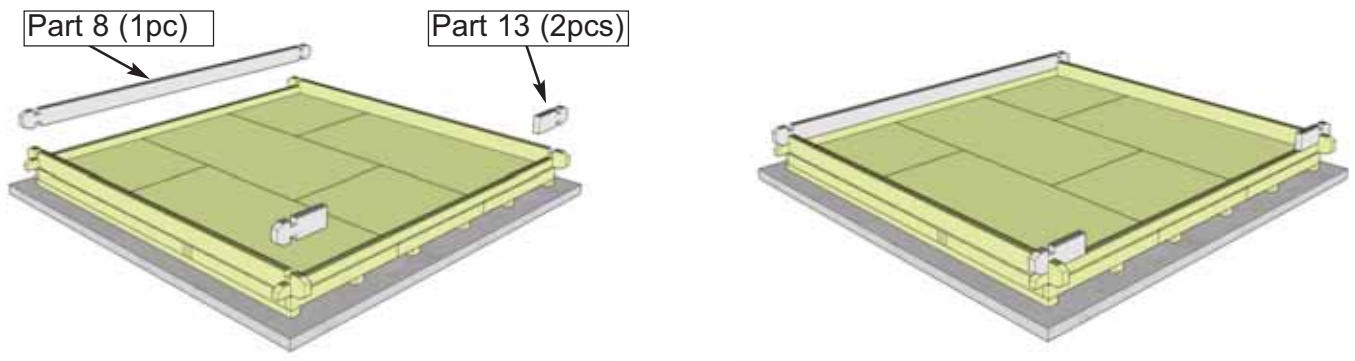

11. Locate a **Part 8** and 2 **Part 13**'s. Place 1 **Part 8** at the rear of Cabin and 2 **Part 13**'s at the front. Fasten each notch with **1 - 3"** screw.

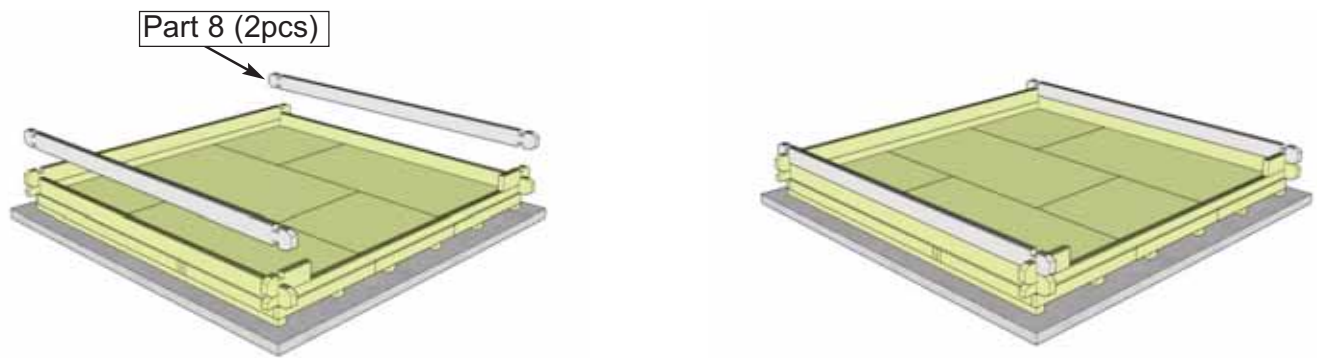

12. Locate 2 more **Part 8**'s, place and fasten as per **Step 10**.

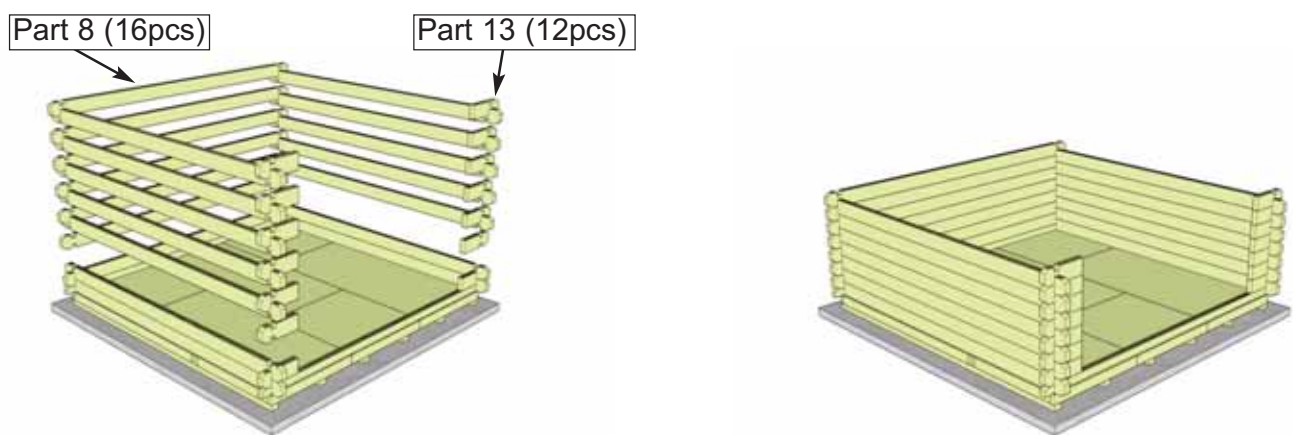

13. Continue adding **Part 8**'s and **Part 13**'s until your side walls are stacked 7 boards high.

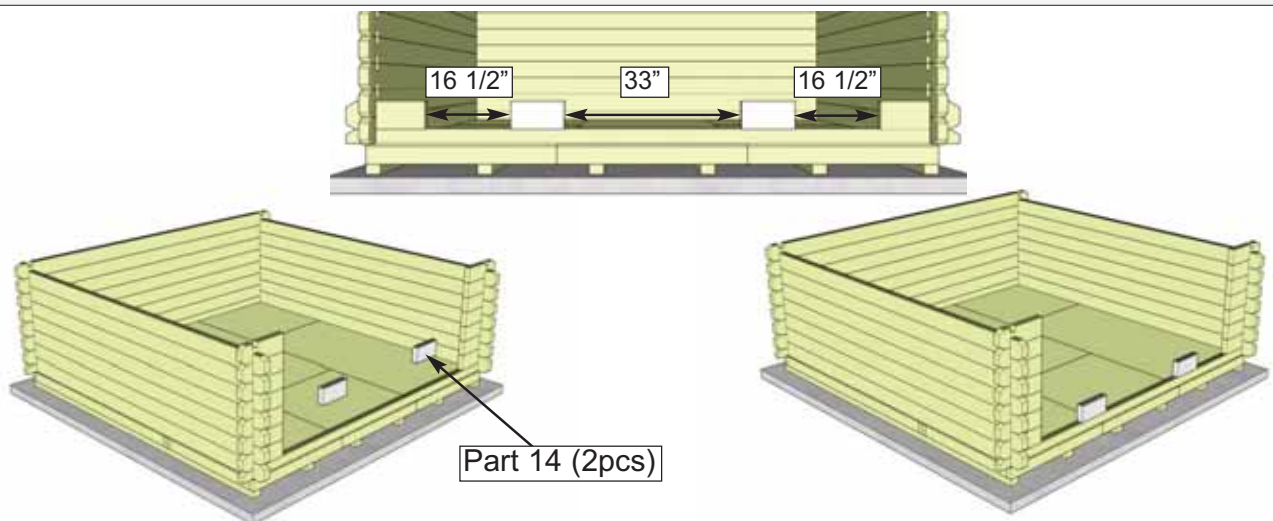

14. Locate **Part 14** (14 Total). Position **Part 14**'s approximately 16 1/2" inches from **Part 13**. Use the Door and Windows from **Step 15** to confirm position, then secure each piece to **Part 1** with 2 - 3" screws.

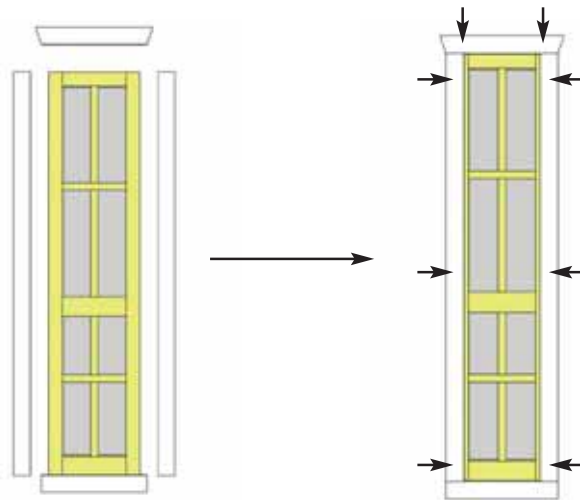

Note: Attach both top and side trims to front window panels before installation.

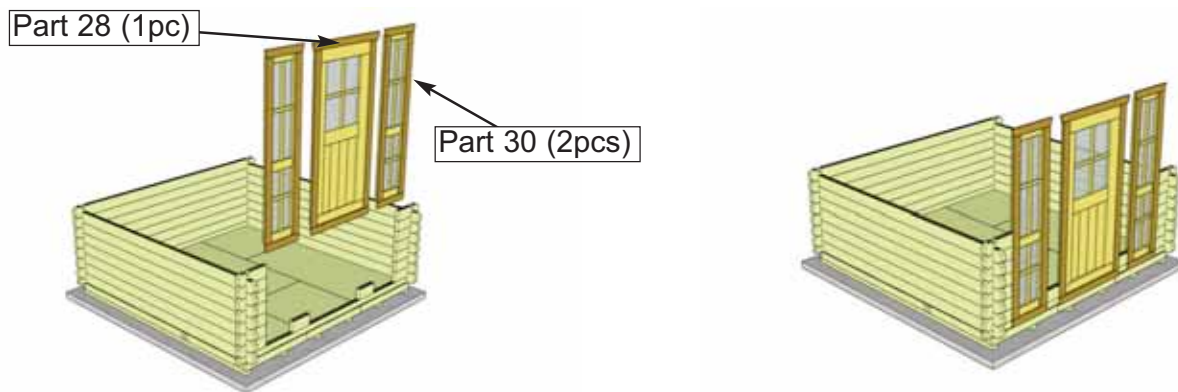

15. Locate **Part 28** (Door) and **Parts 30** (Front Windows). Ensure Door and Windows fit between **Part 14**'s previously installed. Use a shim to keep the door off the ground. If you find it easier to assemble the Bunkie without the doors you can leave them uninstalled till **Step 23**.

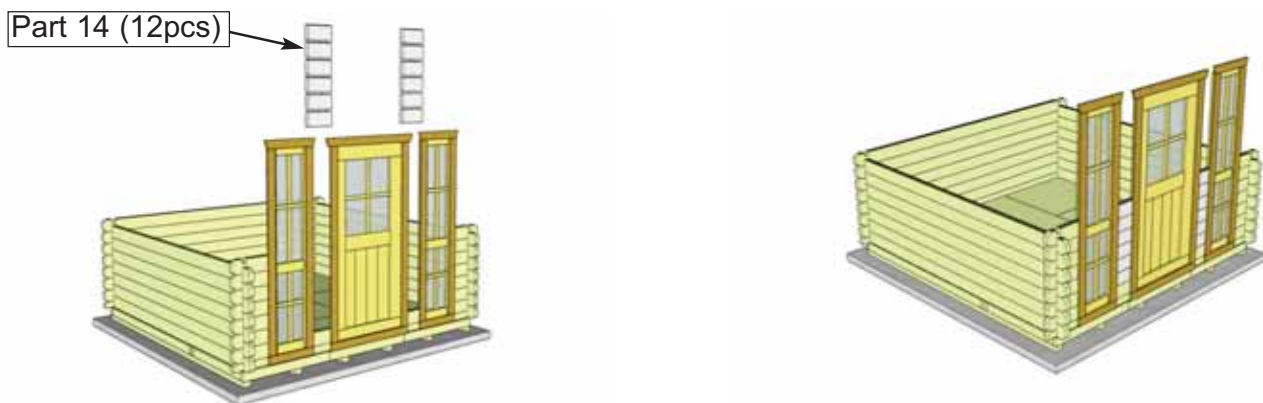

16. Locate **Parts 14** (12 Total) to finish lower wall section. Stack each **Part 14** between front window and doors until you reach 7 high.

3. Upper Wall Section

Exploded view of all parts necessary to complete the Wall Section. Identify all parts prior to starting.

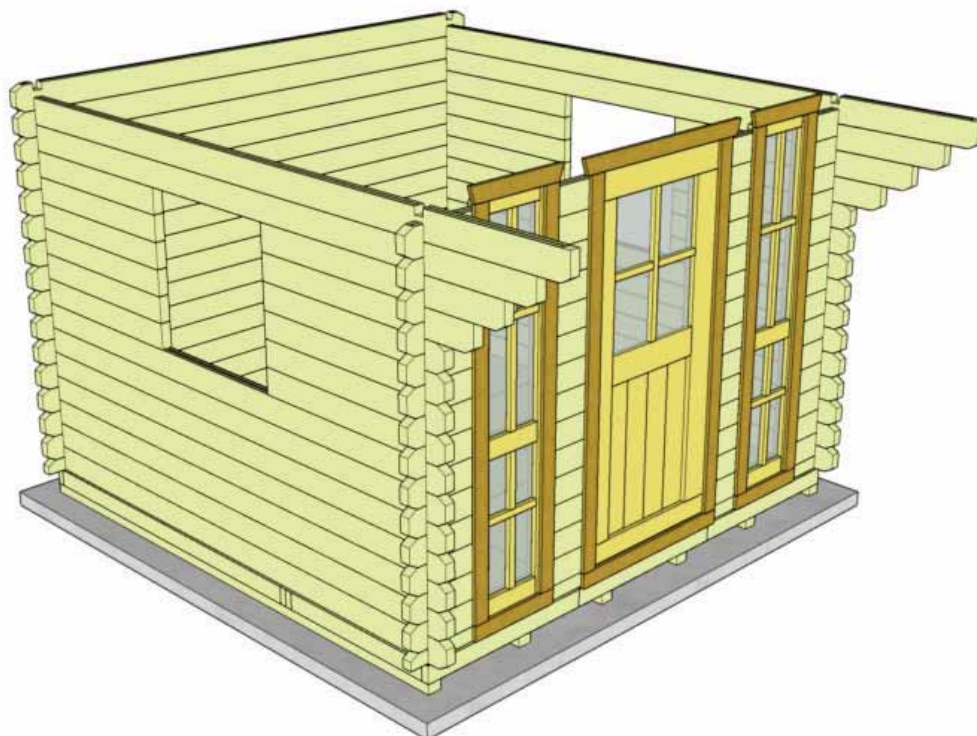
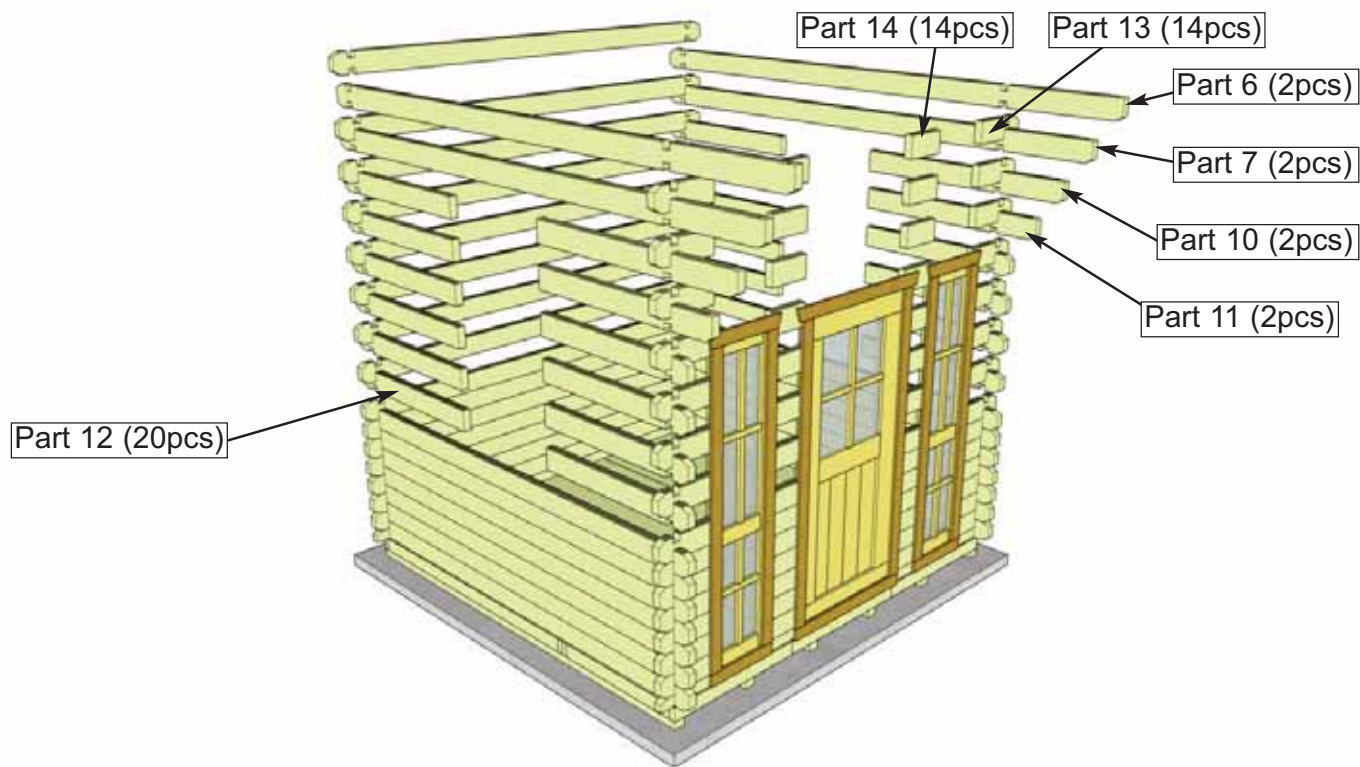

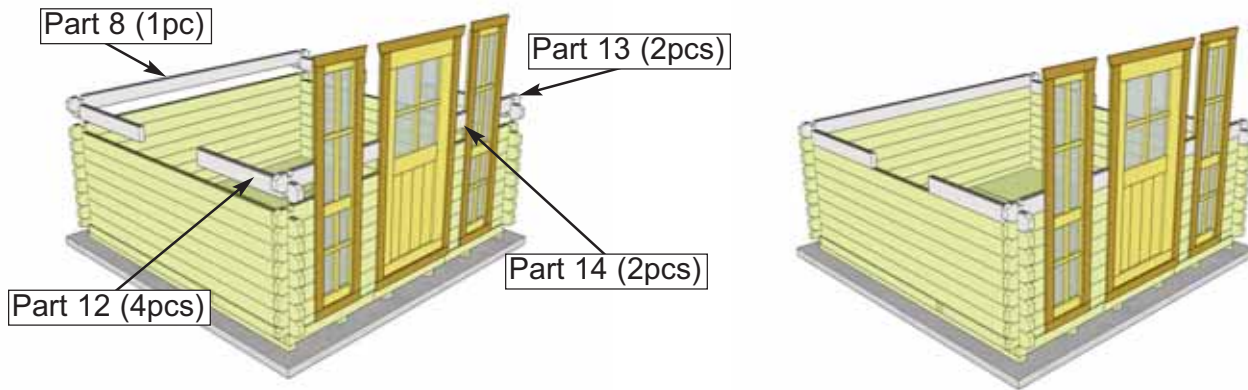

17. Locate **Parts 12** (20 Total) and 1 **Part 8** for the rear wall. Part 12's will allow for a window opening while continue to build the walls.

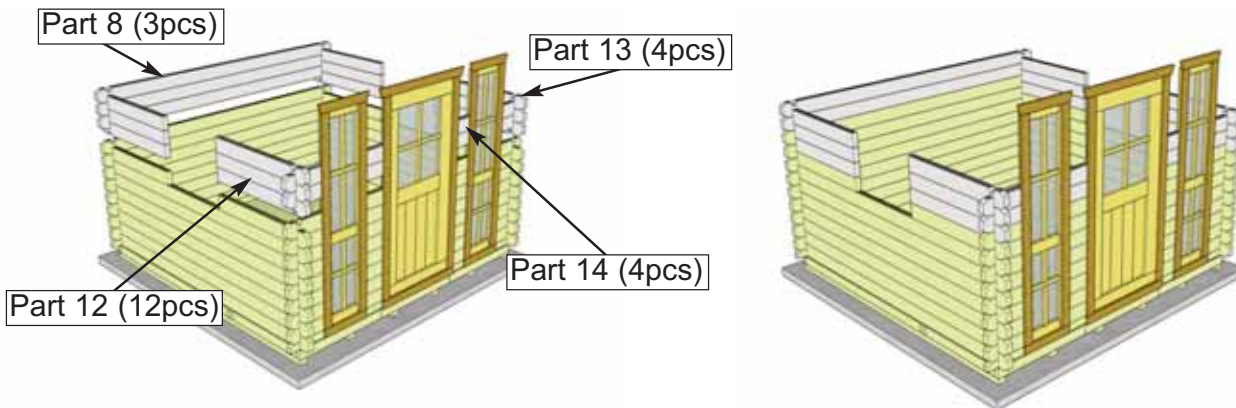

18. Continue building the walls as per **Step 17** until you have added boards 4 high around the window opening.

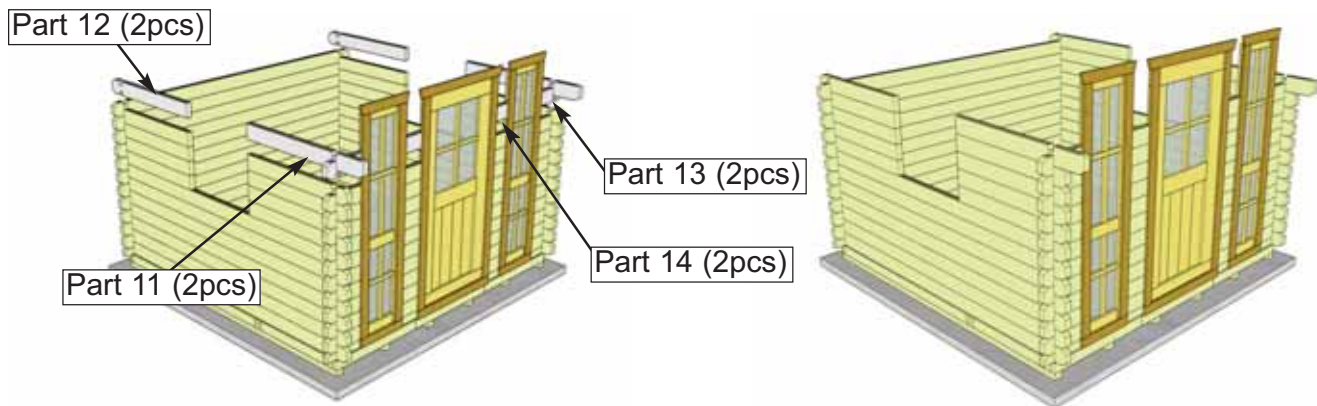

19. Locate **Parts 11** (2 Total). Continue adding to your walls as per **Steps 17-18**.

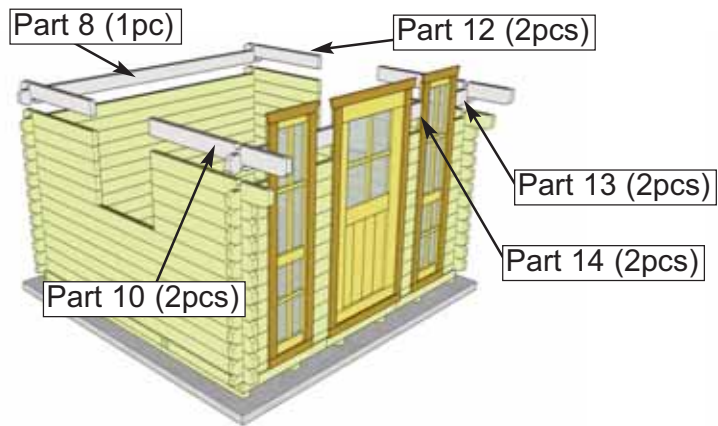

20. Locate **Parts 10** (2 Total). Continue adding to your walls as per **Steps 17-18** but replace the front **Part 12**'s with **Part 10**'s. Place one on each side.

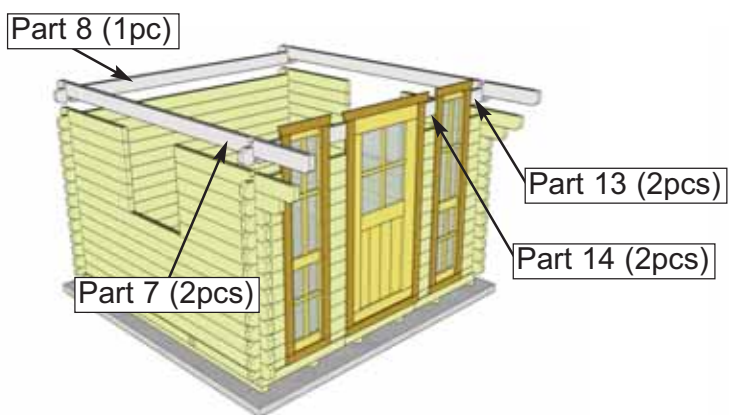

21. Locate **Parts 7** (2 Total). With boards stacked 6 high on either side of the window opening, Place a **Part 7** on top above the window opening.

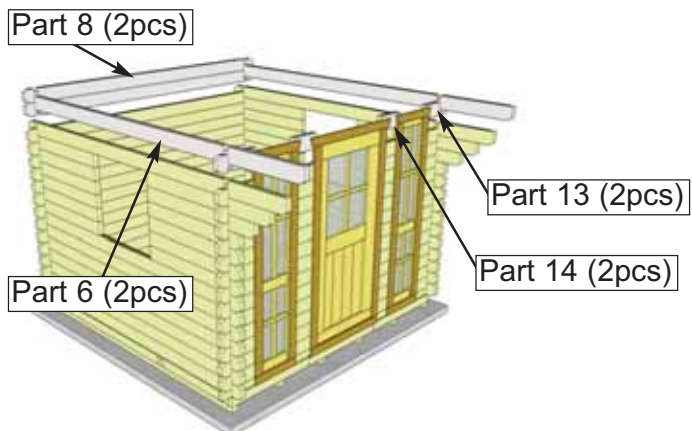

22. Locate **Parts 6** (2 Total). Attach Part 6 above Part 7 to complete upper wall section.

4. Loft Wall Section

Exploded view of all parts necessary to complete the Wall Section. Identify all parts prior to starting.

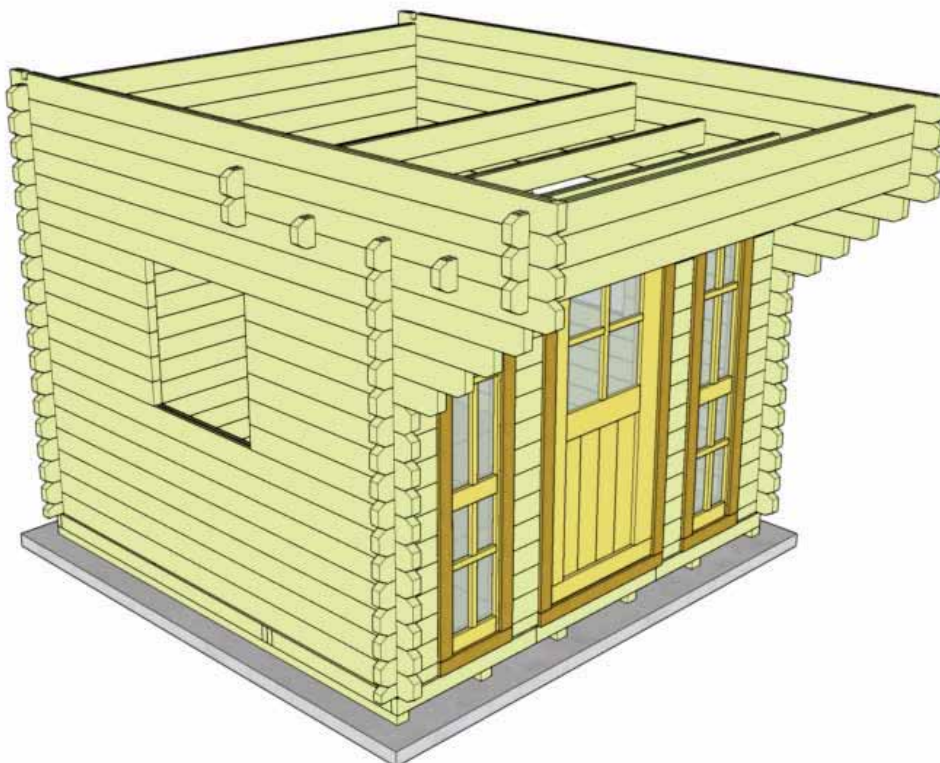
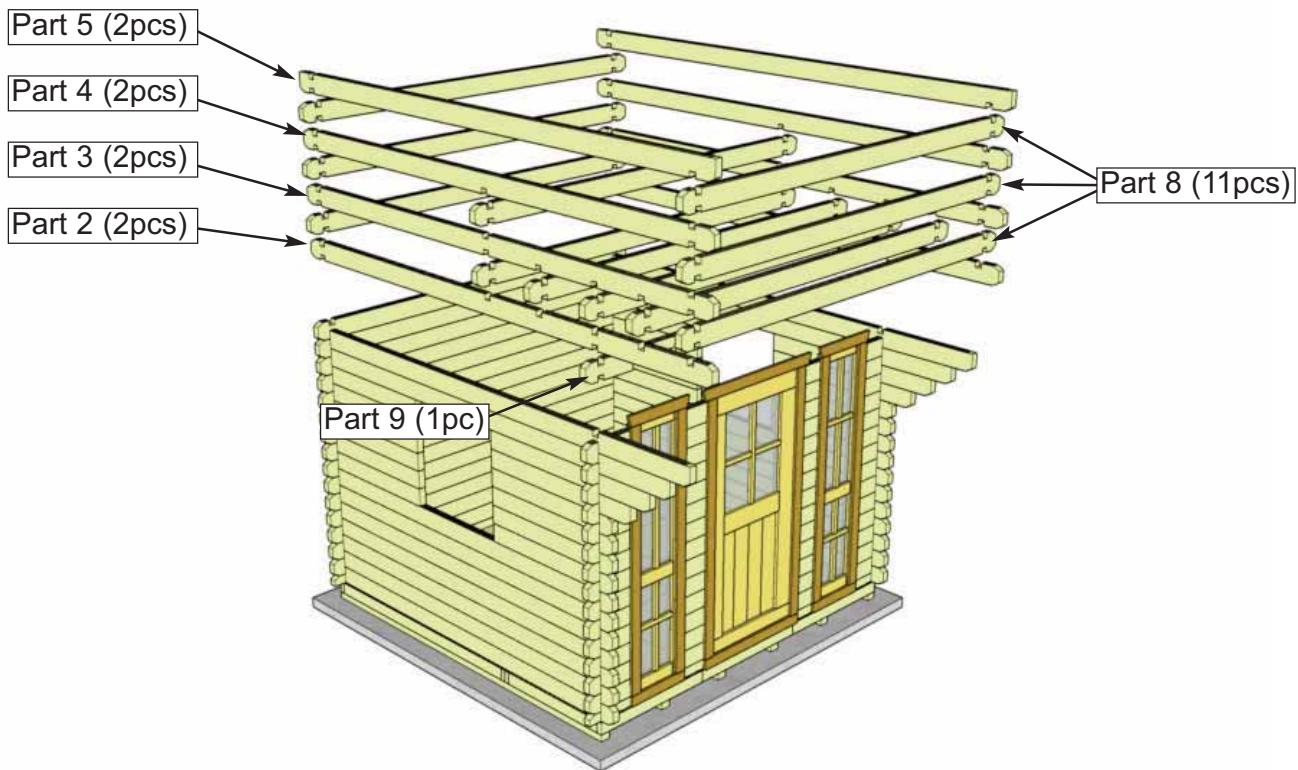

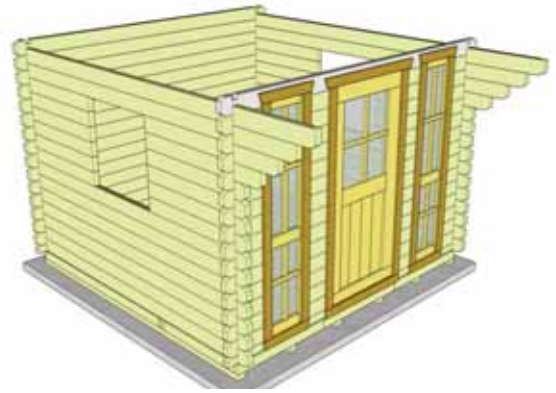
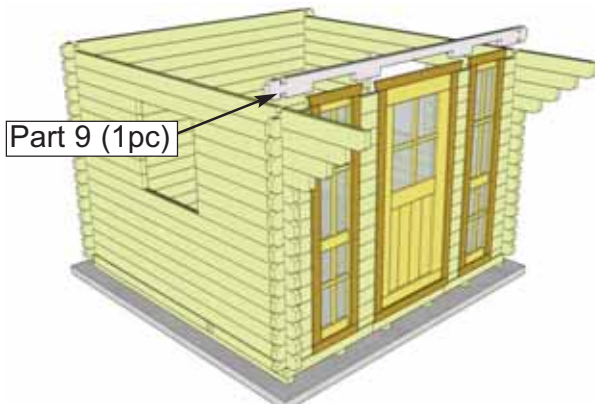

23. Locate **Part 9** (1 Total). Part 9 is notched out to fit over the front door and windows. If the front door and windows have not been installed yet, install them now.

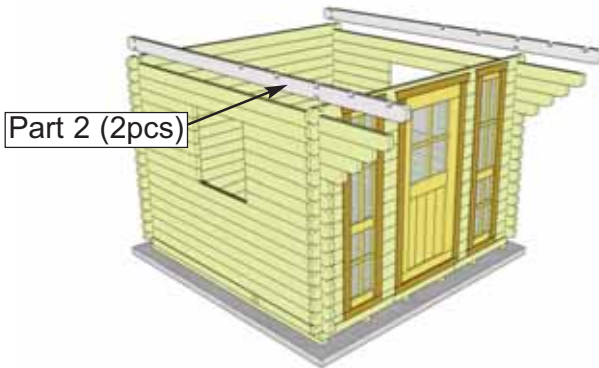

24. Locate **Parts 2** (2 Total). Position on side walls and fasten.



25. Locate **Parts 8** (4 Total) & **Parts b1** (2 Total). Position on roof as illustrated above and fasten.

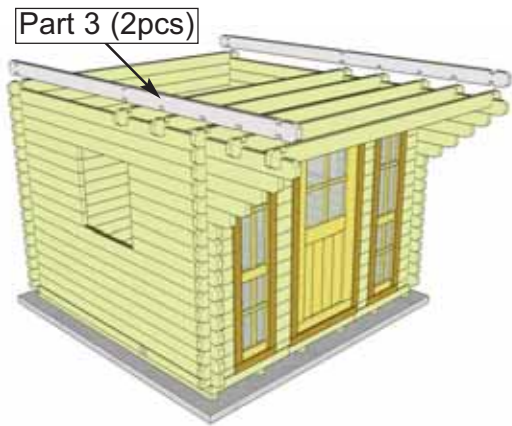

26. Locate **Parts 3** (2 Total). Position on side walls and fasten.

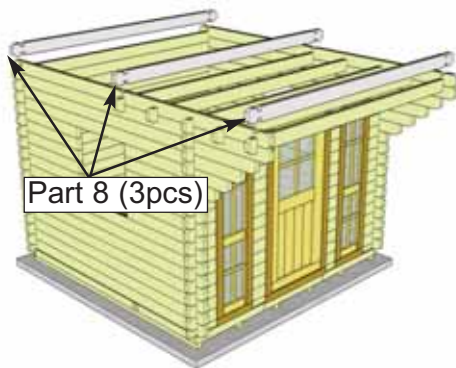

27. Locate **Parts 8** (3 Total). Position and fasten.

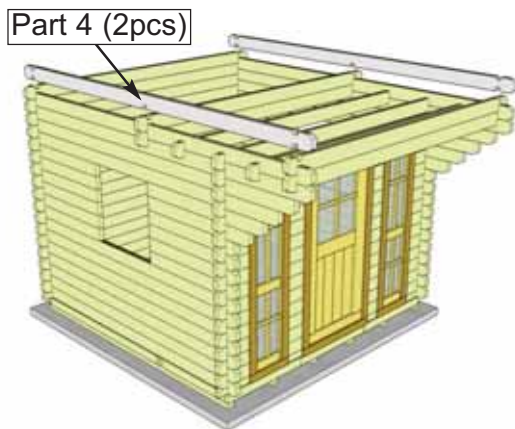

28. Locate **Parts 4** (2 Total). Position on side walls and fasten

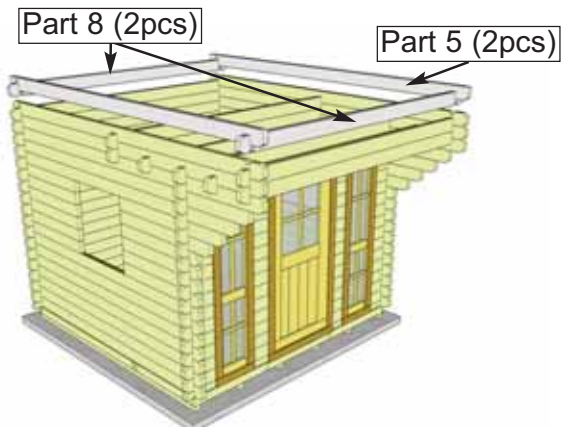

29. Locate **Parts 5** (2 Total). Position on side walls and fasten

5. Loft Section

Exploded view of all parts necessary to complete the Wall Section. Identify all parts prior to starting.

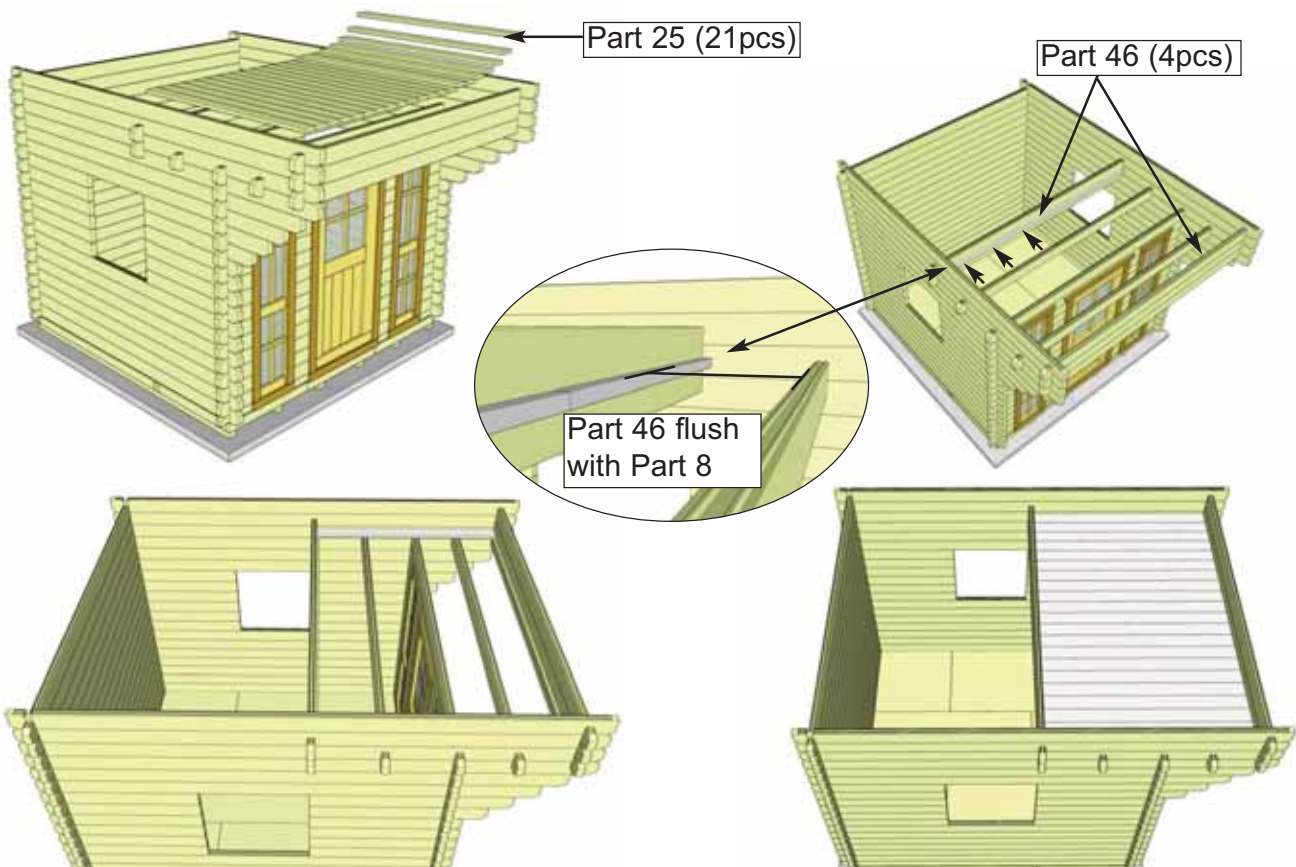

30. First install **Part 46** with **3 - 2" screws** per strip to support floor boards. Locate **Parts 25** (21 Total). Place on loft rafters (**Parts b1 & 8**). With floor boards in position secure each board to loft rafters with **4 - 2" screws** per piece (84 Total). Be sure to screw through floor boards into loft rafters. You can use the end pieces profile as a guide.

6. Gable & Rafter Section

Exploded view of all parts necessary to complete the Wall Section. Identify all parts prior to starting.

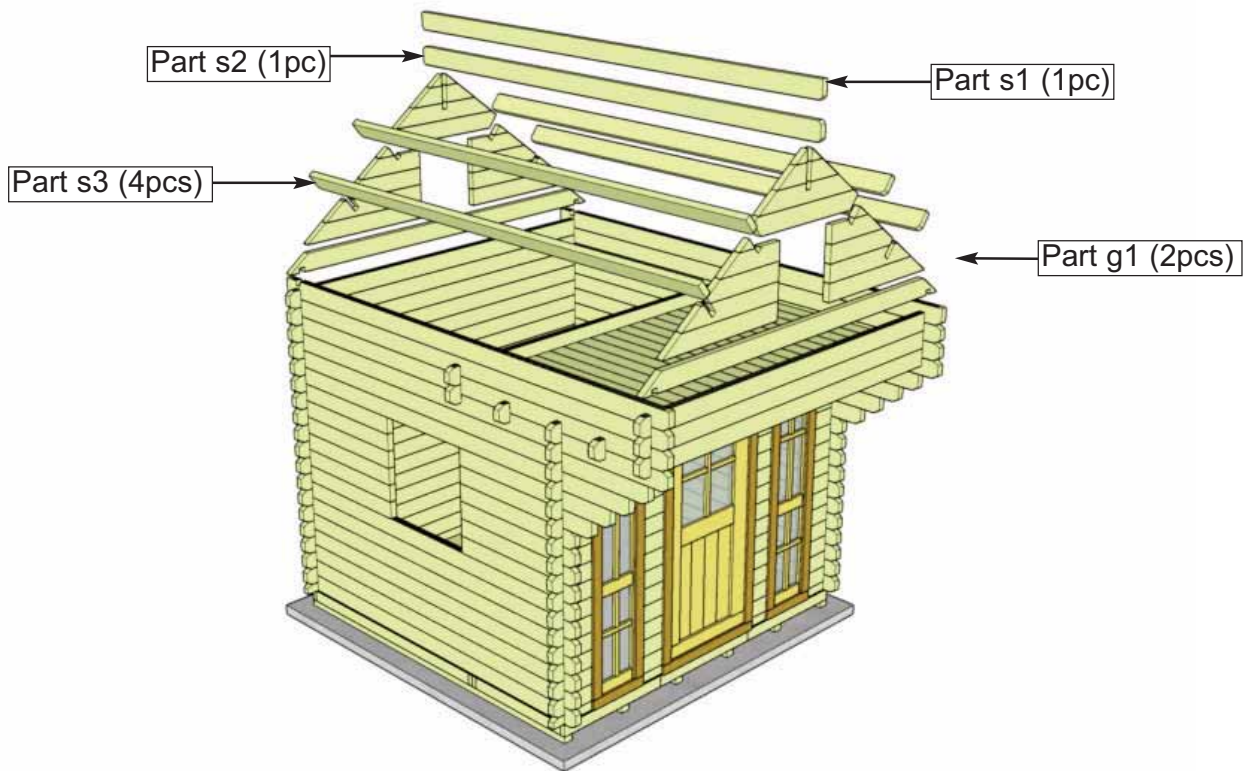

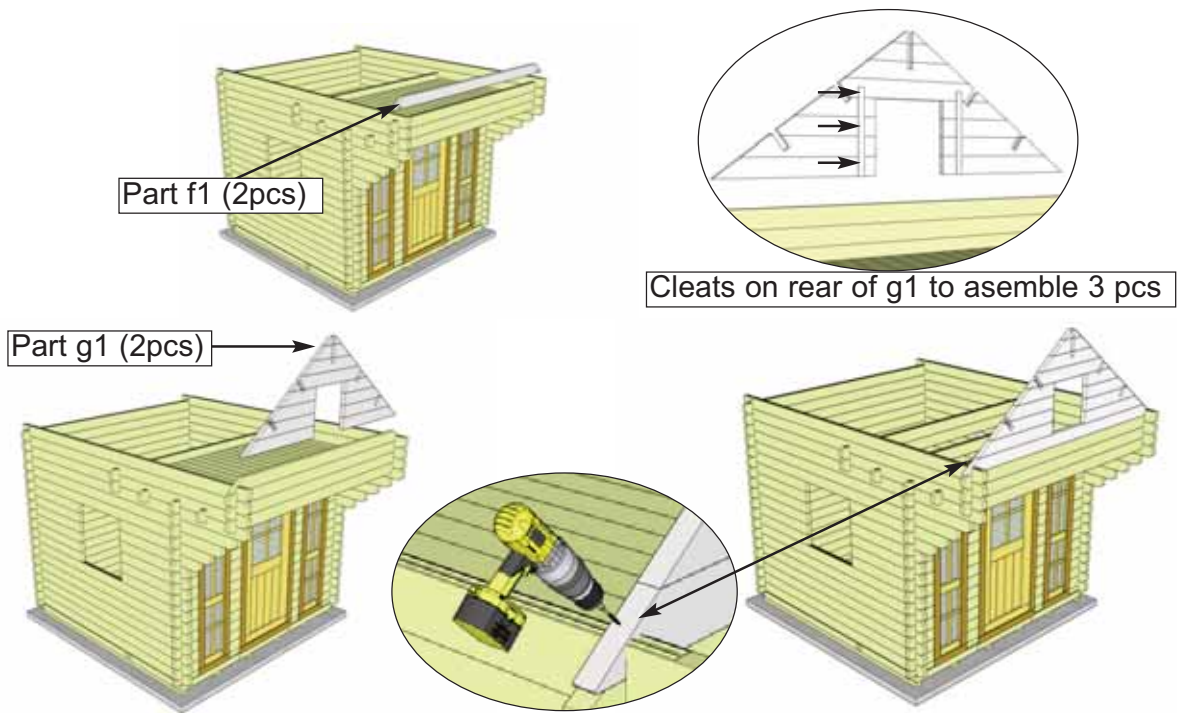

31. Locate **Parts f1 & g1** (4 Total). Place **f1** on each edge of roof, resting on Part 8's. Fasten with **2 - 2" screws** per side at a **45°**. Place **g1** on **f1** and attach the same way. Complete both gables.

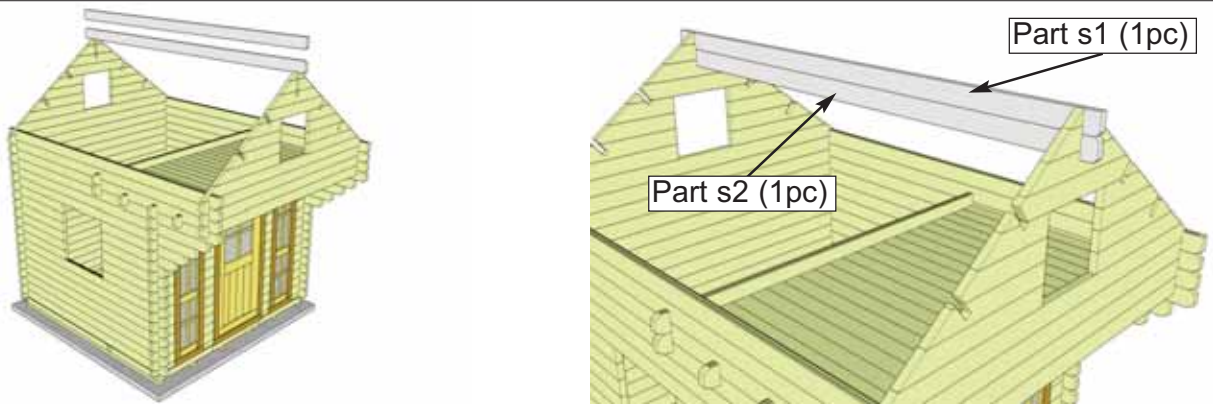

32. Locate **Parts s2 & s1** (2 Total). Position in top notch of gables with Part **s2** on the bottom and part **s1** on the top as illustrated above. Evenly space from front to back, approximately **5"** of overhang. Ensure rafter ends are flush.



33. Locate **Parts s3** (4 Total). Position in side notches of gables as illustrated above. Evenly space from front to back, approximately **5"** of overhang. Ensure rafter ends are flush.

7. Roof Section

Exploded view of all parts necessary to complete the Wall Section. Identify all parts prior to starting.

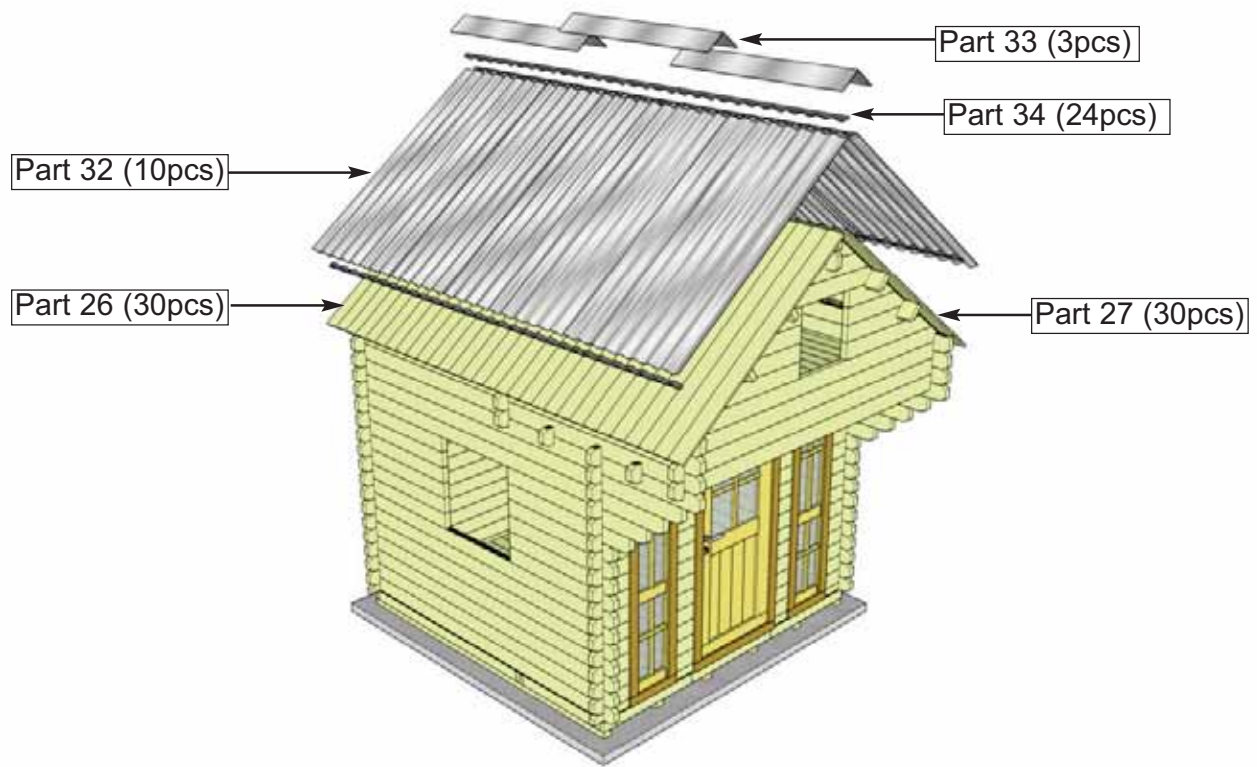

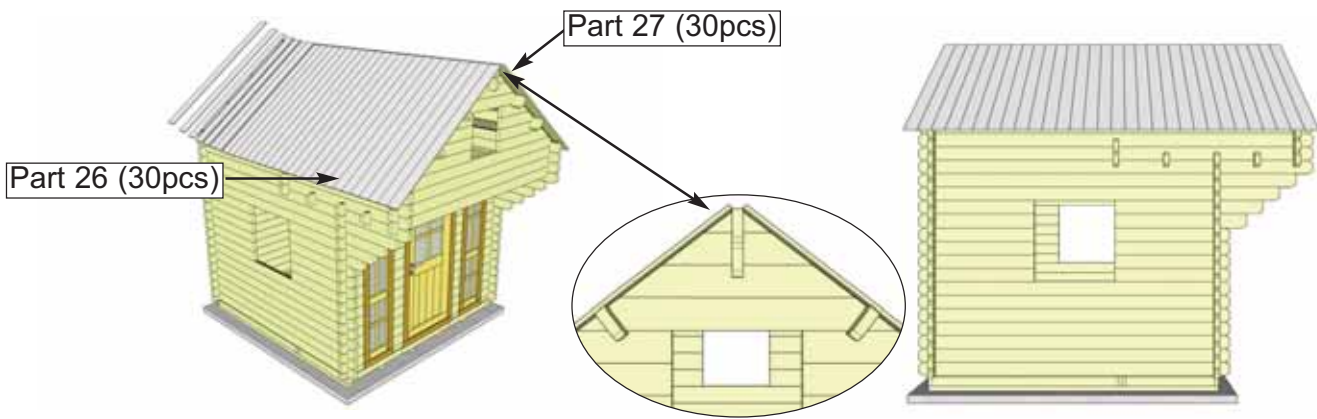

34. Locate **Parts 26 & 27** (60 Total). Position roof boards onto rafters overhanging equally on front and rear of Bunkie. Be sure to position roof boards with the smooth face down as these will be seen from inside. Fasten each board to roof using **4 - 1 1/4" screws** per piece into rafters.

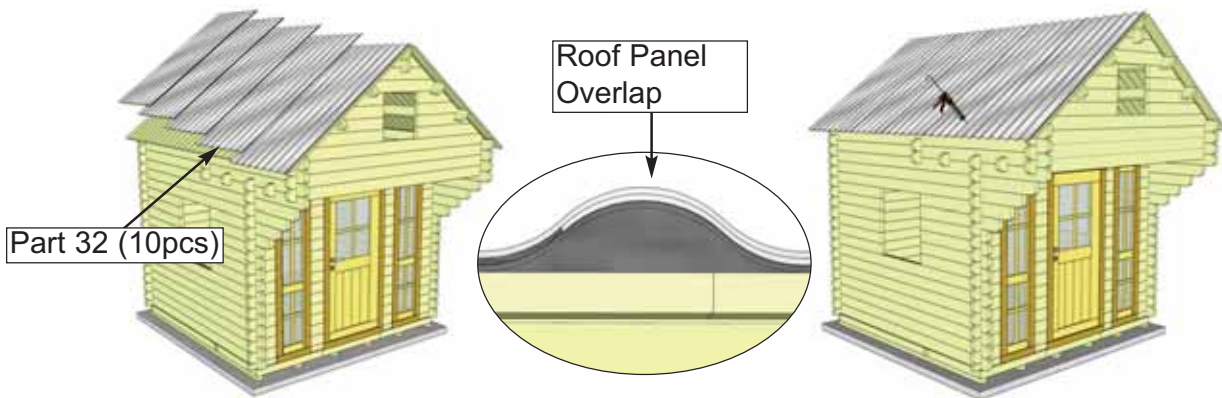

35. Locate **Parts 32** (10 Total). Position roof panels onto roof boards overhanging equally on front and rear of Bunkie. Lift up each panel and caulk the seam where the panels overlap.

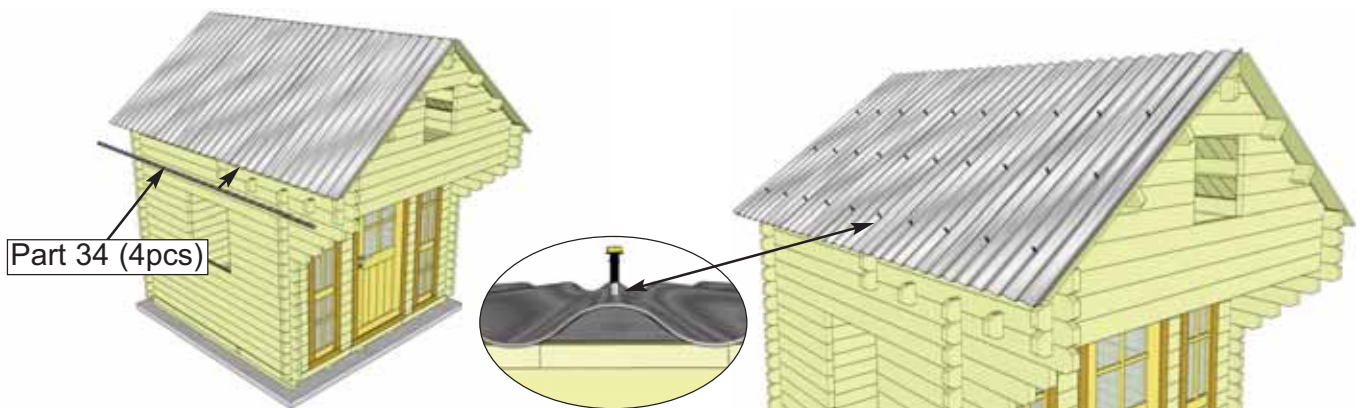

36. Locate **Parts 34** (8 Total, 4 per side). Position Foam Enclosures between Metal Roof Panels and Roof Boards before fastening roof. Secure panels to roof with **30 - 2" Metal Screws** and included **1/4" nut driver**. Metal Roof Screws are self tapping, do not overtighten. Position screws so they go through the peak of roof panels and into Rafters (use rafter ends as a guide). Use 3 rows of 10 screws. Leave the peak unsecured for now. Repeat for opposite side of roof. Complete both sides.

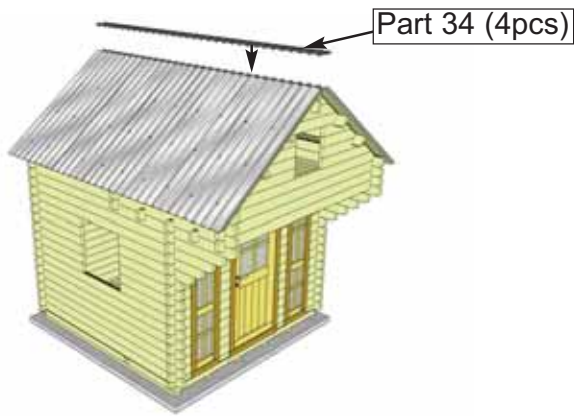

37. Locate **Parts 34** (8 Total, 4 per side). Position near peak of roof on top of Roof Panels.



38. Locate **Parts 33** (3 Total). Position on peak of roof over top of Foam Enclosures. Overlap the 3 Ridge Caps and space apart to achieve desired overhang. Once in Position fasten each side of Ridge Cap to roof with **10 - 2" Metal Screws** (20 total). Metal Roof screws are self tapping, do not overtighten.

8. Trim Section

Exploded view of all parts necessary to complete the Wall Section. Identify all parts prior to starting.

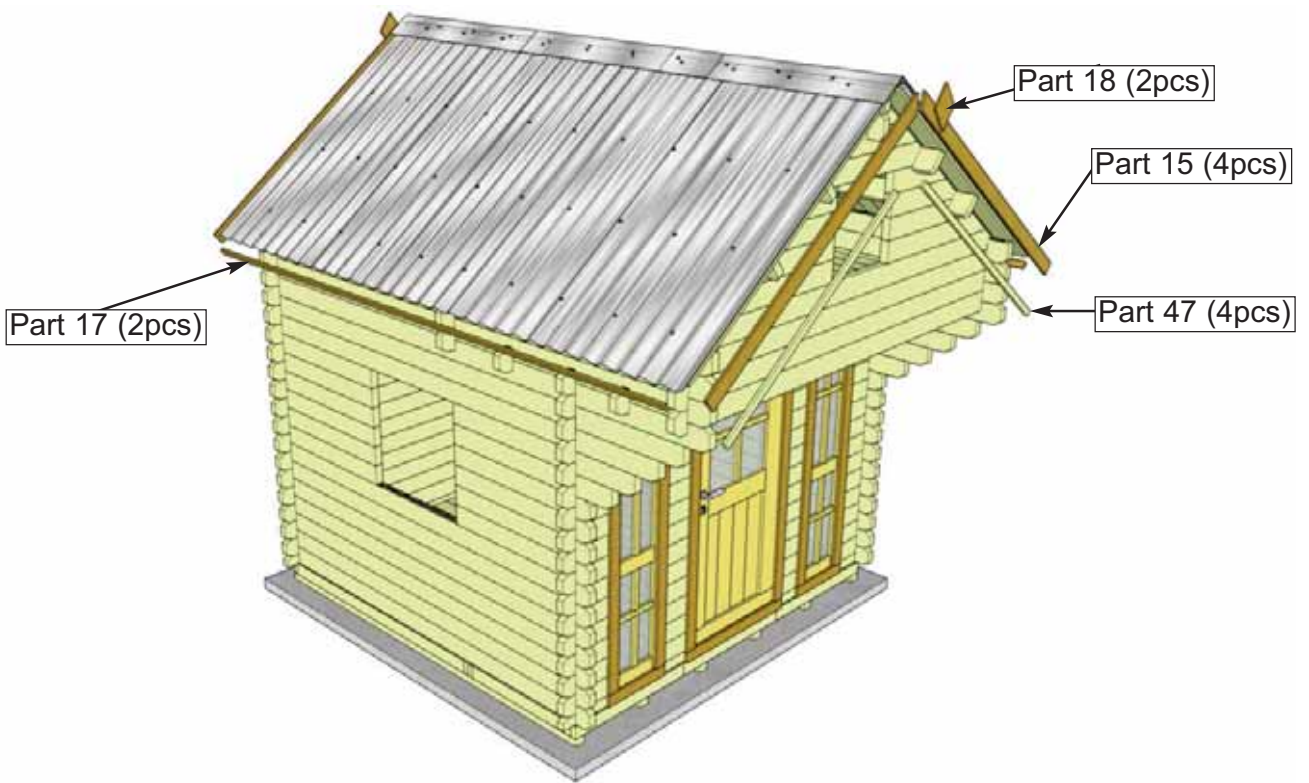

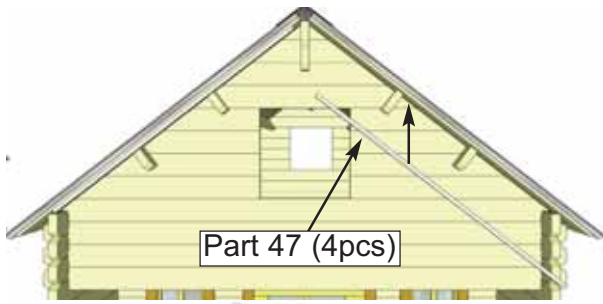

Part 47 (4pcs)

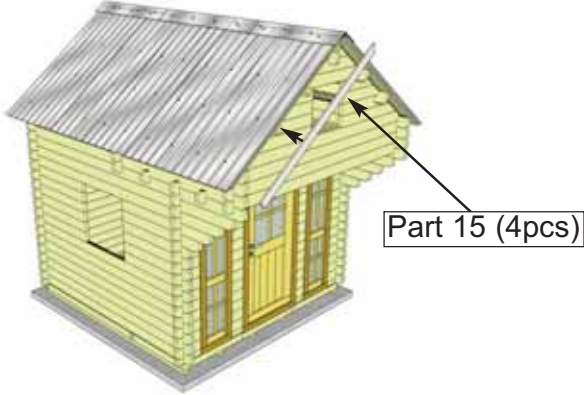

Part 15 (4pcs)



39. Locate **Parts 47** (4 total) and **Parts 15** (4 Total). Attach Part 47's underneath roof boards with **4 - 1 1/4" screws** per piece. Position Front Wind Flap over Rafters and attach with **8 - 1 1/2" finishing nails** per piece. Attach all 4 pieces.



Part 18 (2pcs)



40. Locate **Parts 18** (2 Total). Position Flashing Rhomb over seam in Front Wind Flaps at peak of Roof. Attach each with **4 - 1 1/2" finishing nails** per piece.

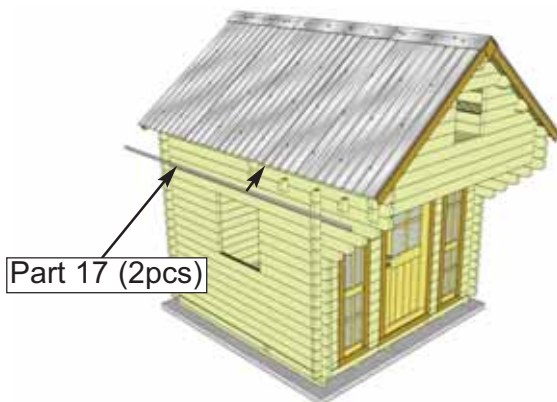

Part 17 (2pcs)



41. Locate **Parts 17** (2 Total). Position Side Wind Flap flush with Roof Boards. Attach with **10 - 1 1/2" Finishing Nails** per piece. Complete both sides.

9. Miscellaneous Section

Exploded view of all parts necessary to complete the Wall Section. Identify all parts prior to starting.

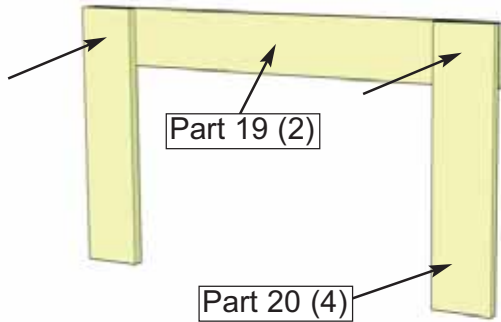

42. Locate **Parts 19 & 20** (6 Total) to assemble loft railing. Fasten **Part 19** to 2 **Part 20**'s with **2 - 1 1/4" screws** per section. Complete two railing sections. Attach each Railing section to loft with **4 - 1 1/4" screws** per railing section.

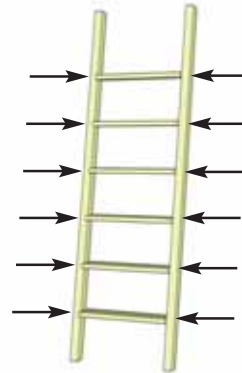

43. Locate **Parts 22** to assemble the ladder. Space steps evenly apart and screw together with **2 - 2 1/2" screws** per step.

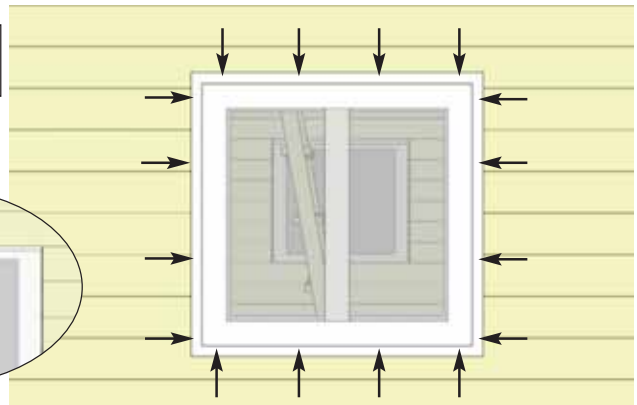
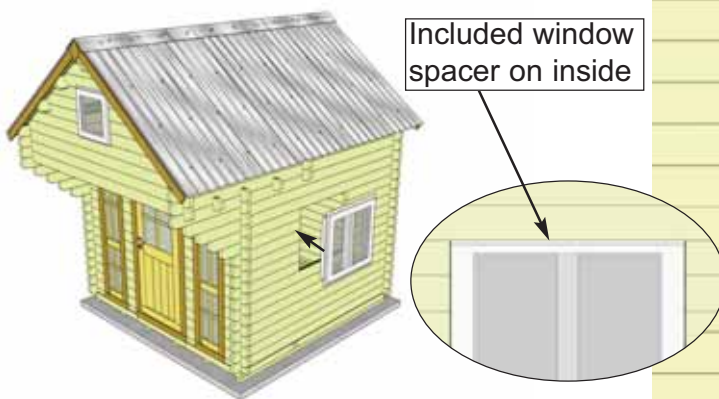

44. Locate **Parts 29 & 31** side windows & loft windows. Fasten Windows to walls through flange in window with **16 - 1 1/4" screws**. Use **Part 41** included spacer to fill gap at top of window on the inside of side windows. Attach all 4 windows.

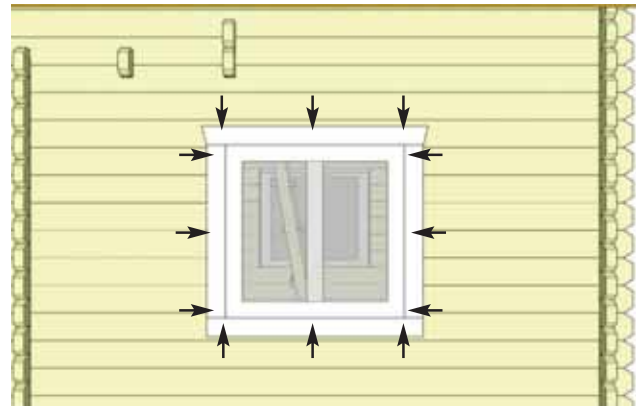
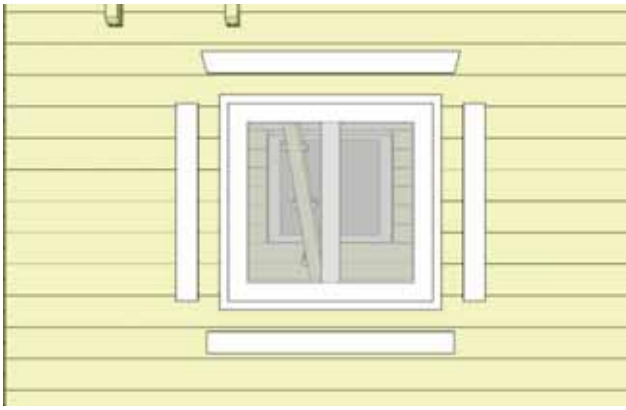

45. Trim out outside of Windows with **Parts 42 & 44** (bundled). Attach with **3 - 1 1/2"** finishing nails per piece (48 total).

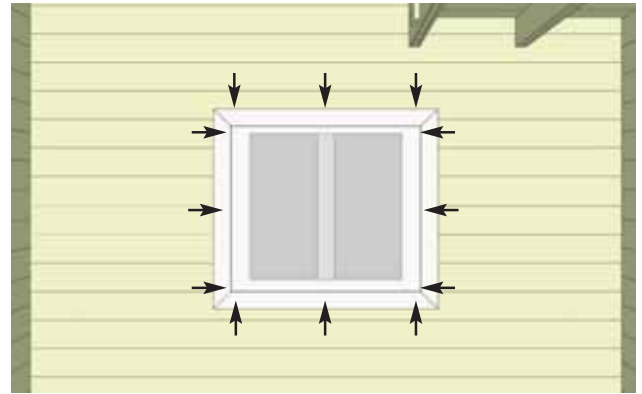
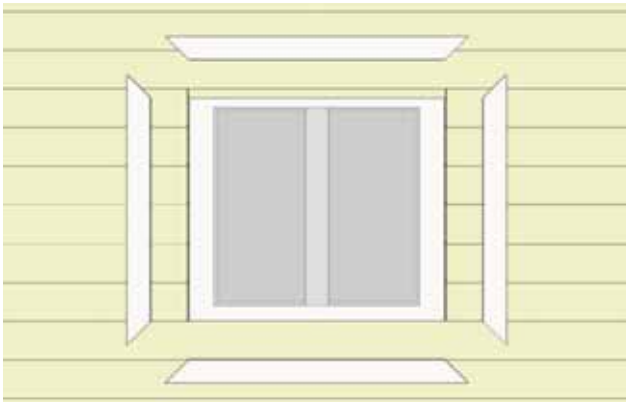

46. Trim out inside of Windows with **Parts 43 & 45** (bundled). Attach with **3 - 1 1/2"** finishing nails per piece (48 total).



47. Lay out Floor Boards **Part 24** on top of plywood floor. Floor Boards are not ID numbered but should be identifiable by size. Screw or nail through face of floor boards into perimeter not into tongue.

Plan of 1st floor in axis 1/2 - A/D

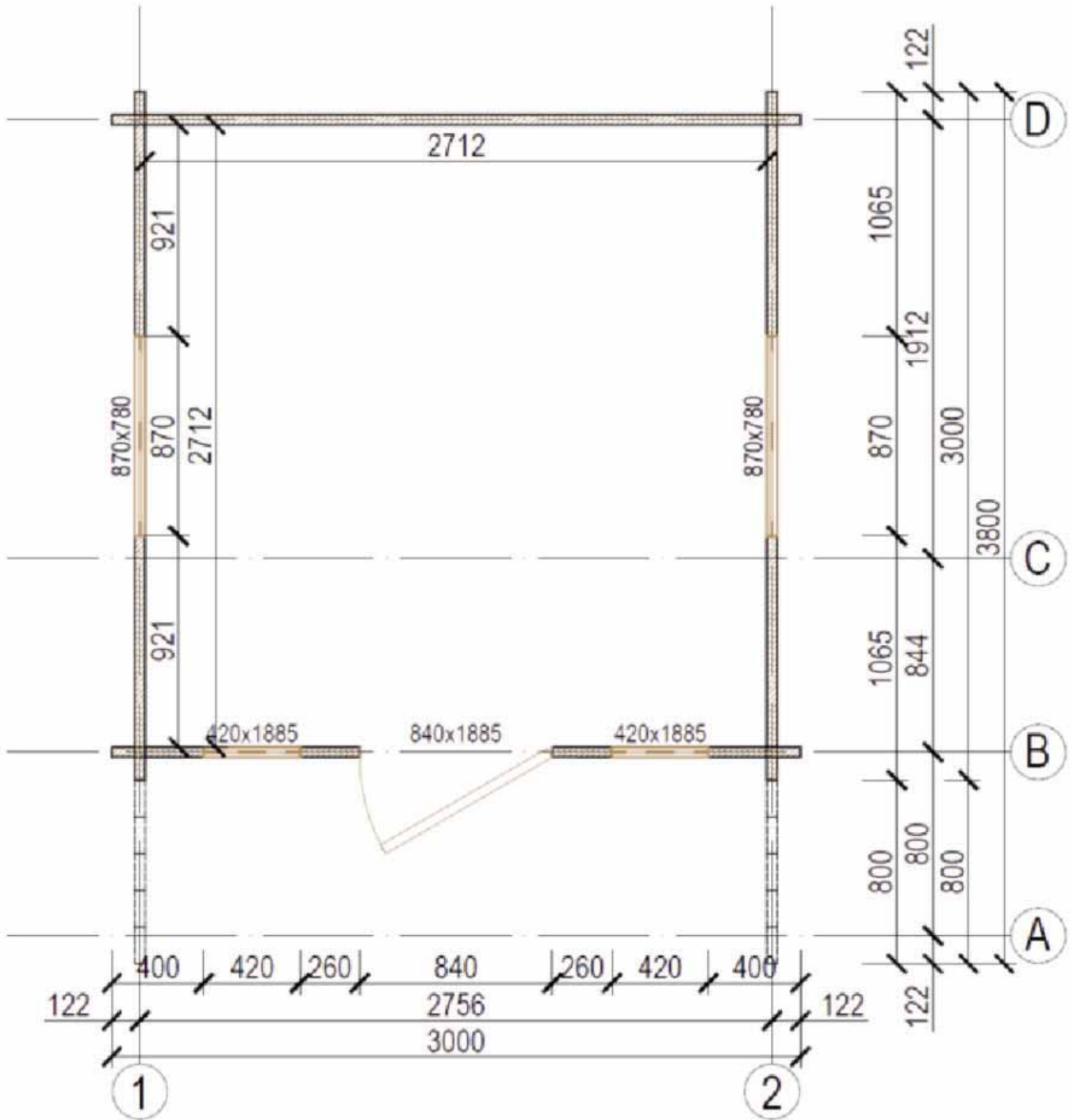

Plan of attic in axis 1/2 - A/D

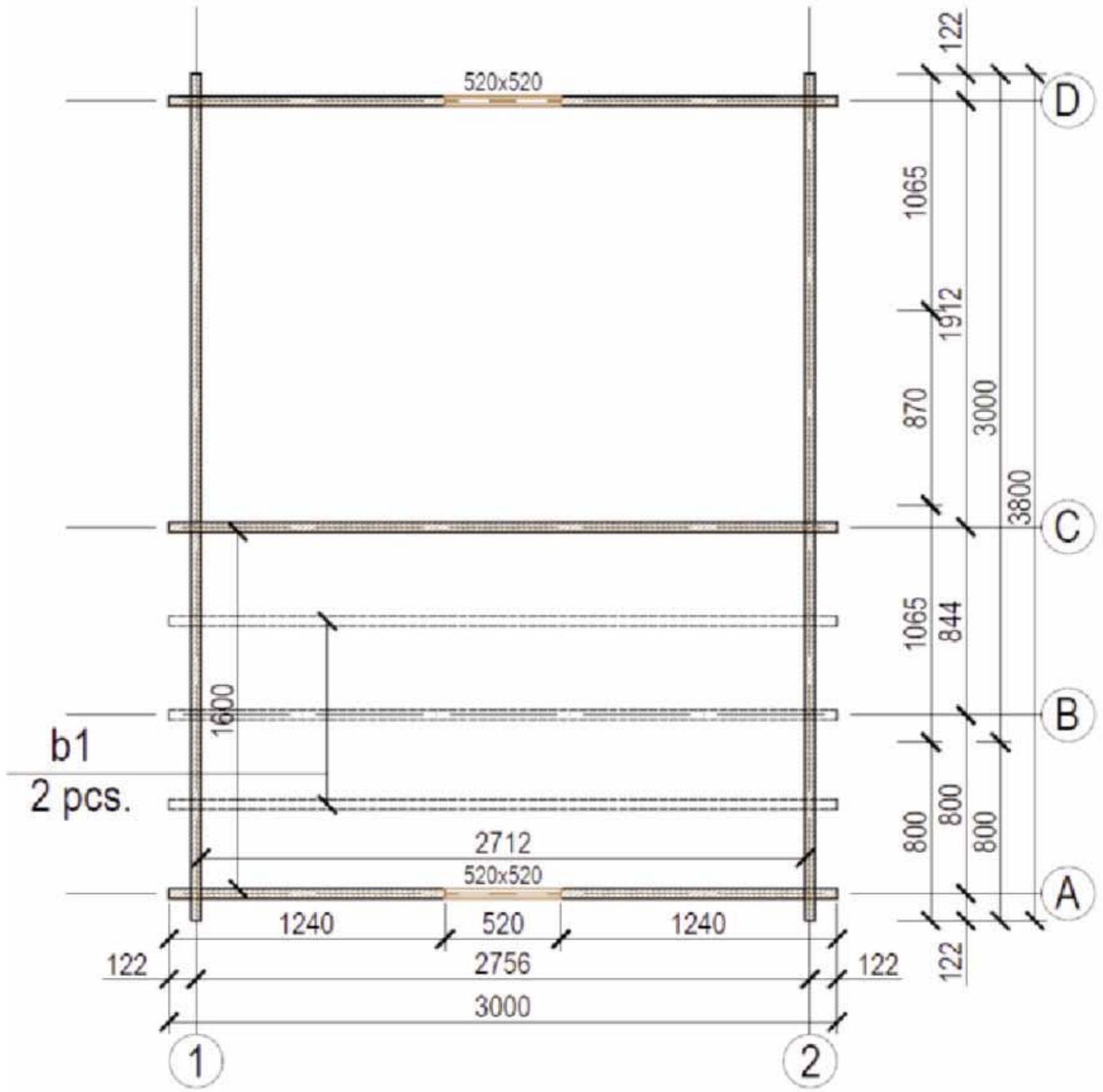

Wall on axis A & B

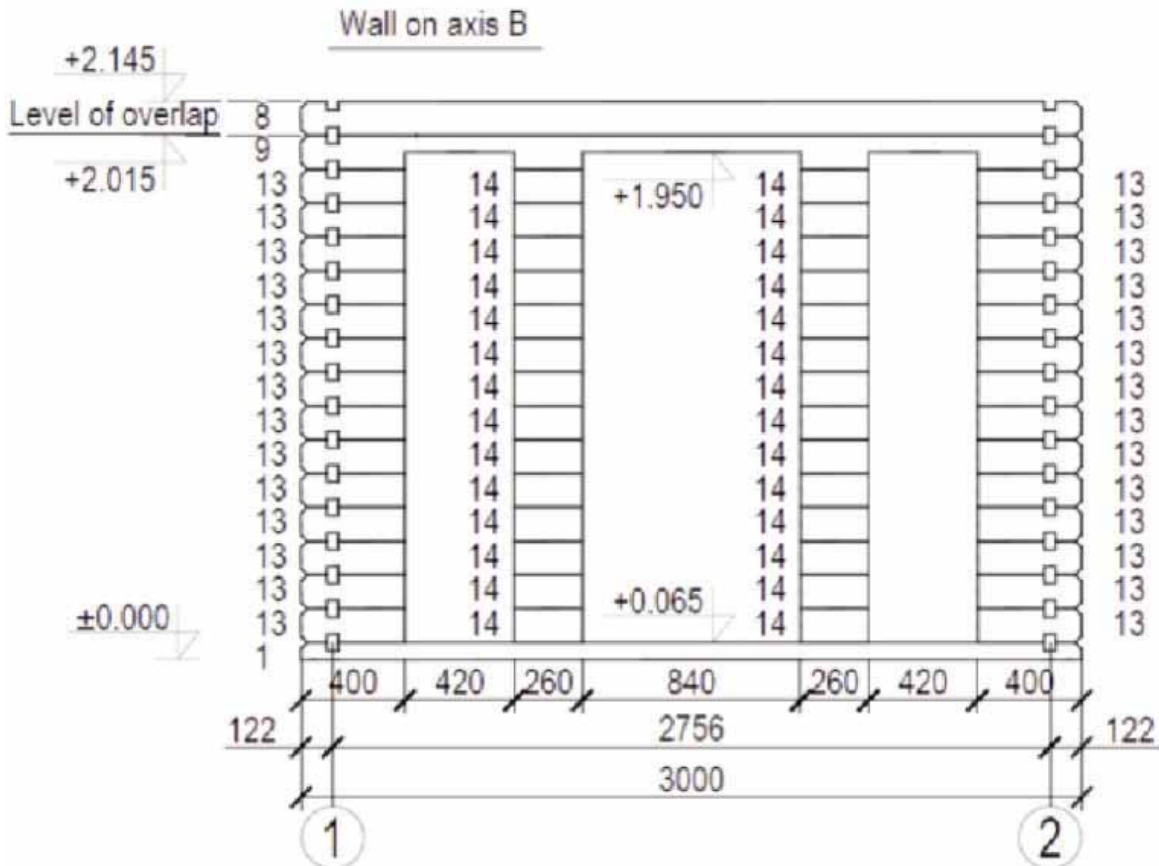
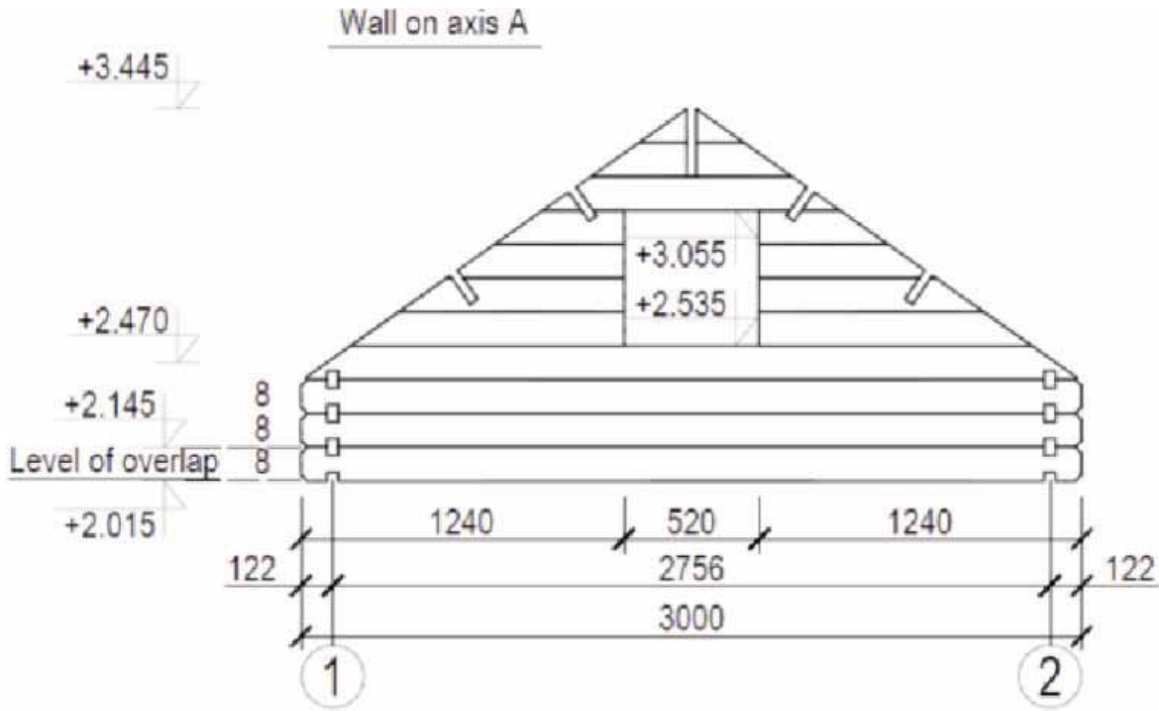

Wall on axis C & D

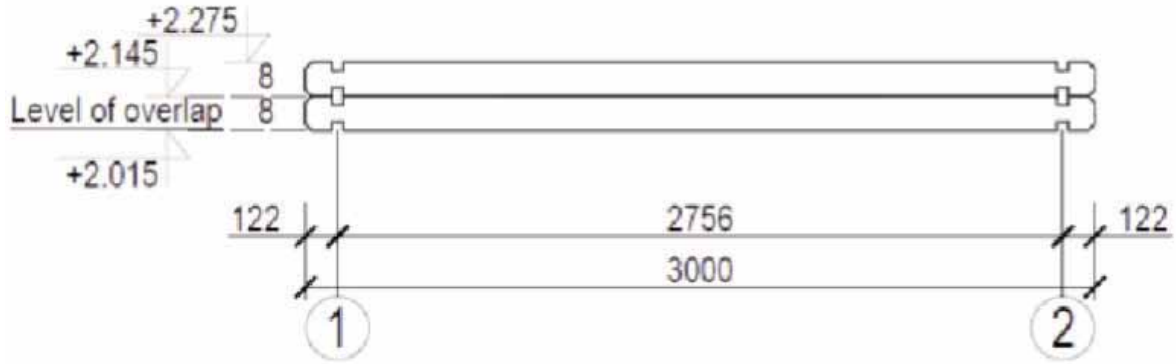

Wall on axis D

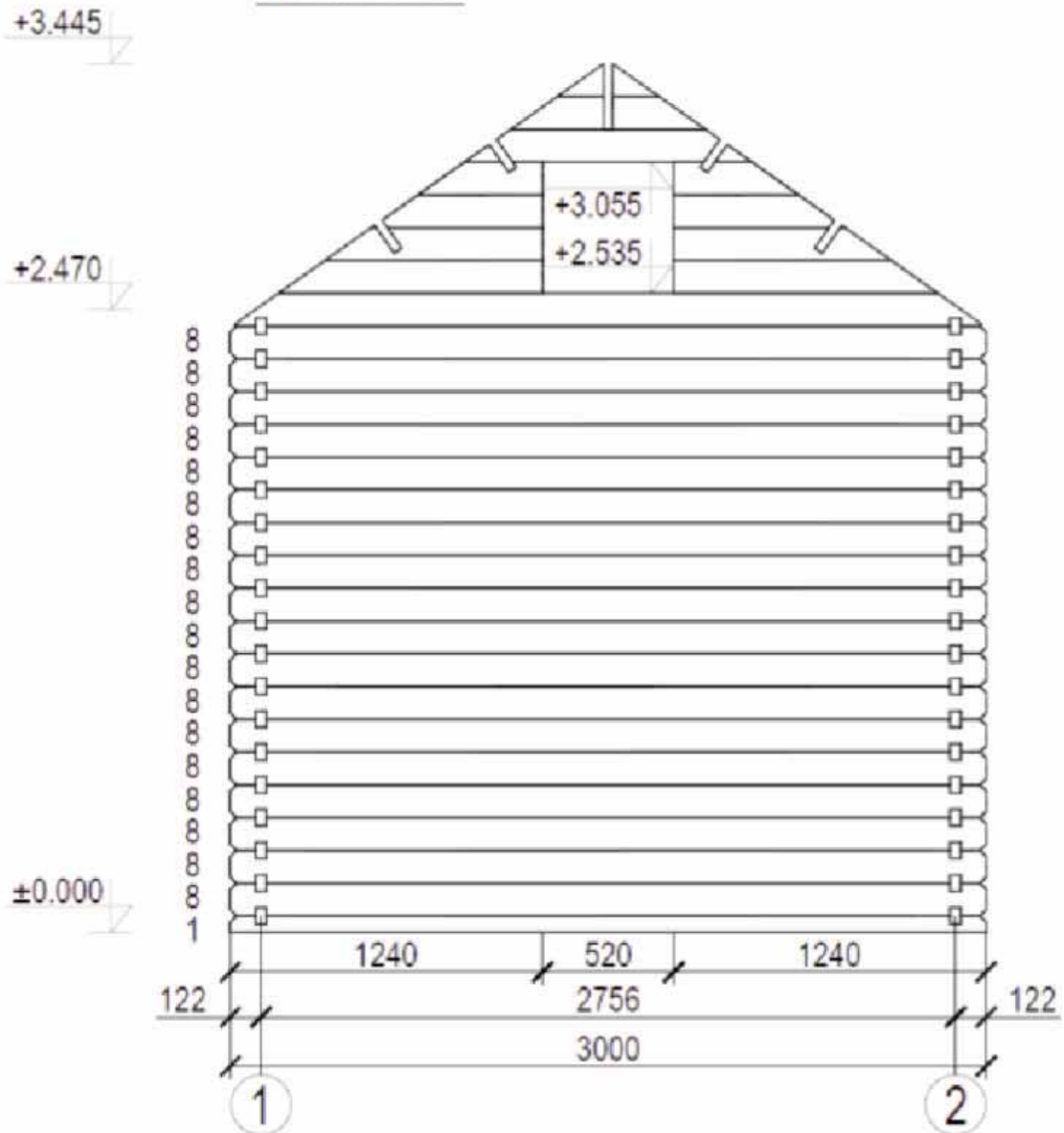

Wall on axis 1

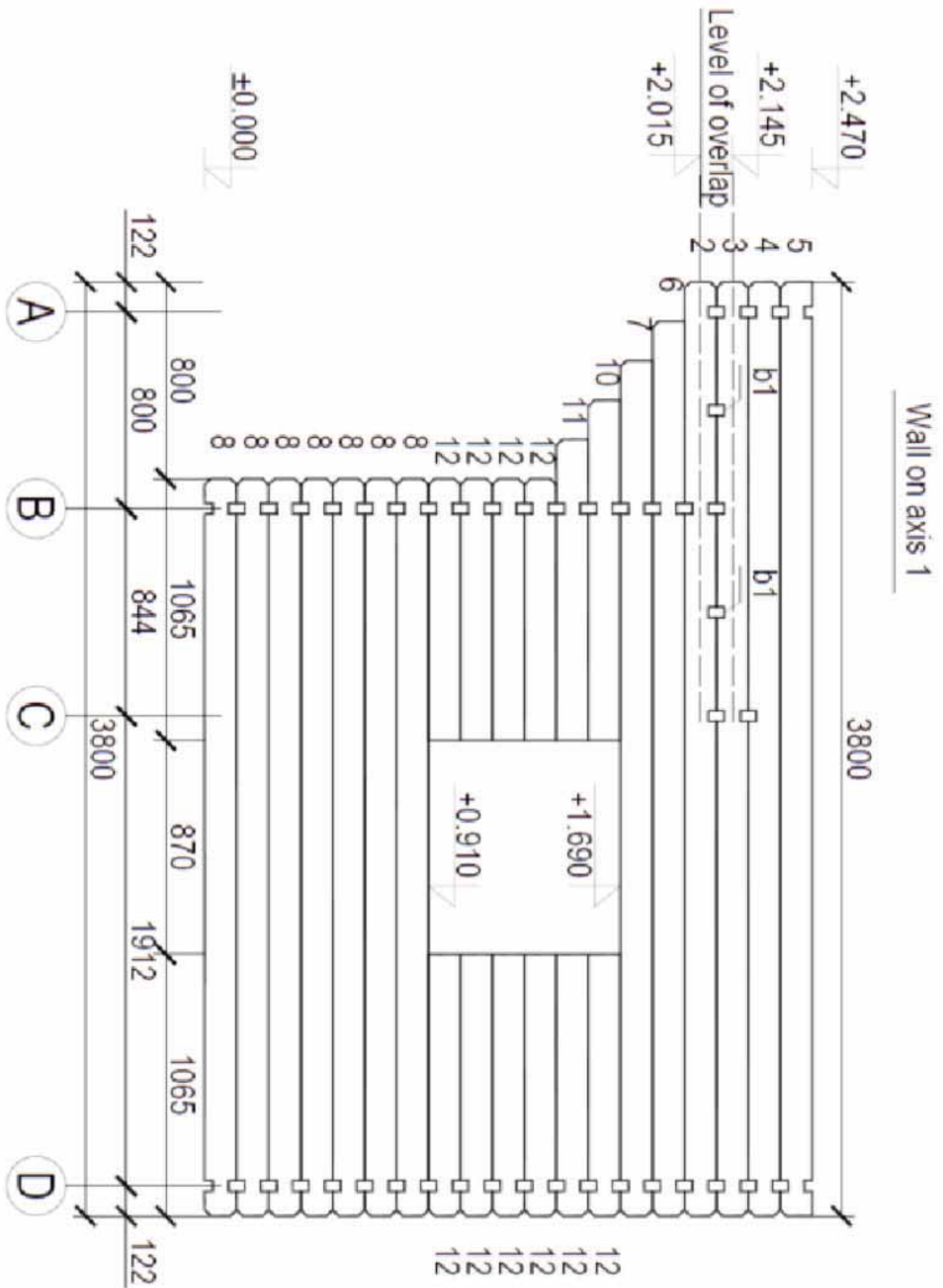

Pediment on axis A & D, & Details

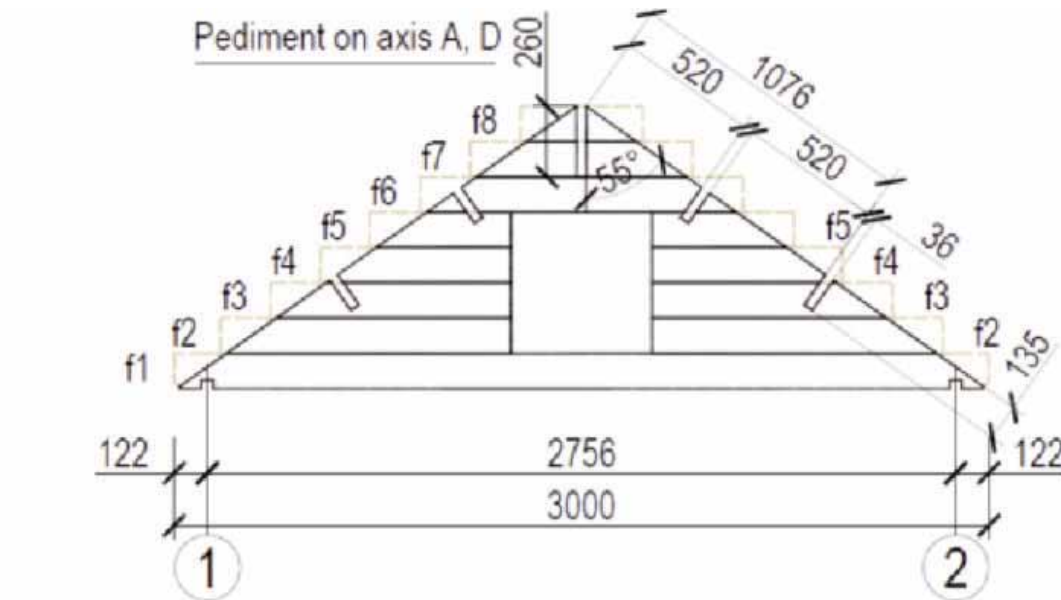

Rafter 44x130

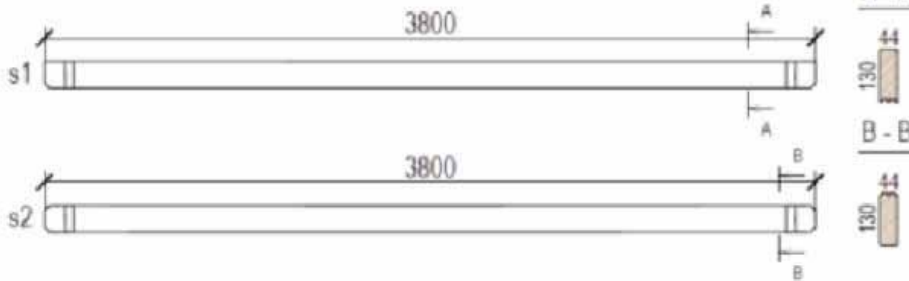

Rafter 44x135

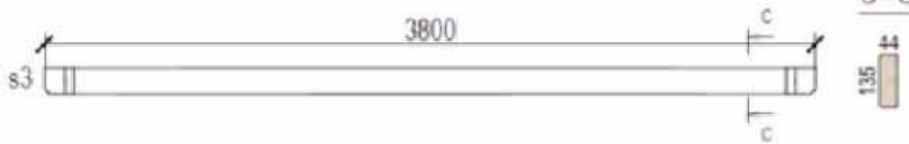

Starting item

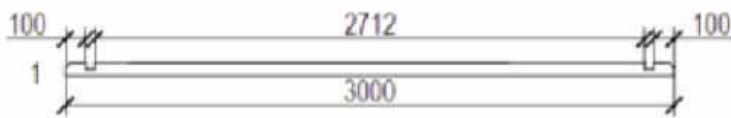

Details

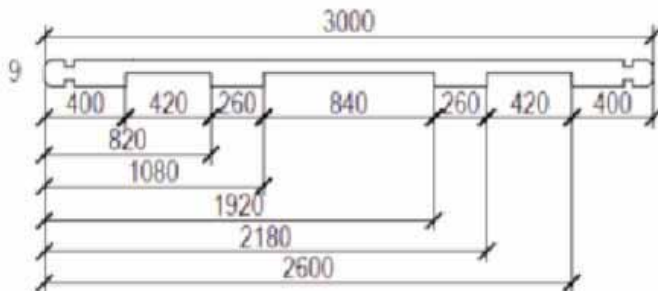

Roof Trim, Rhomb, & Railing

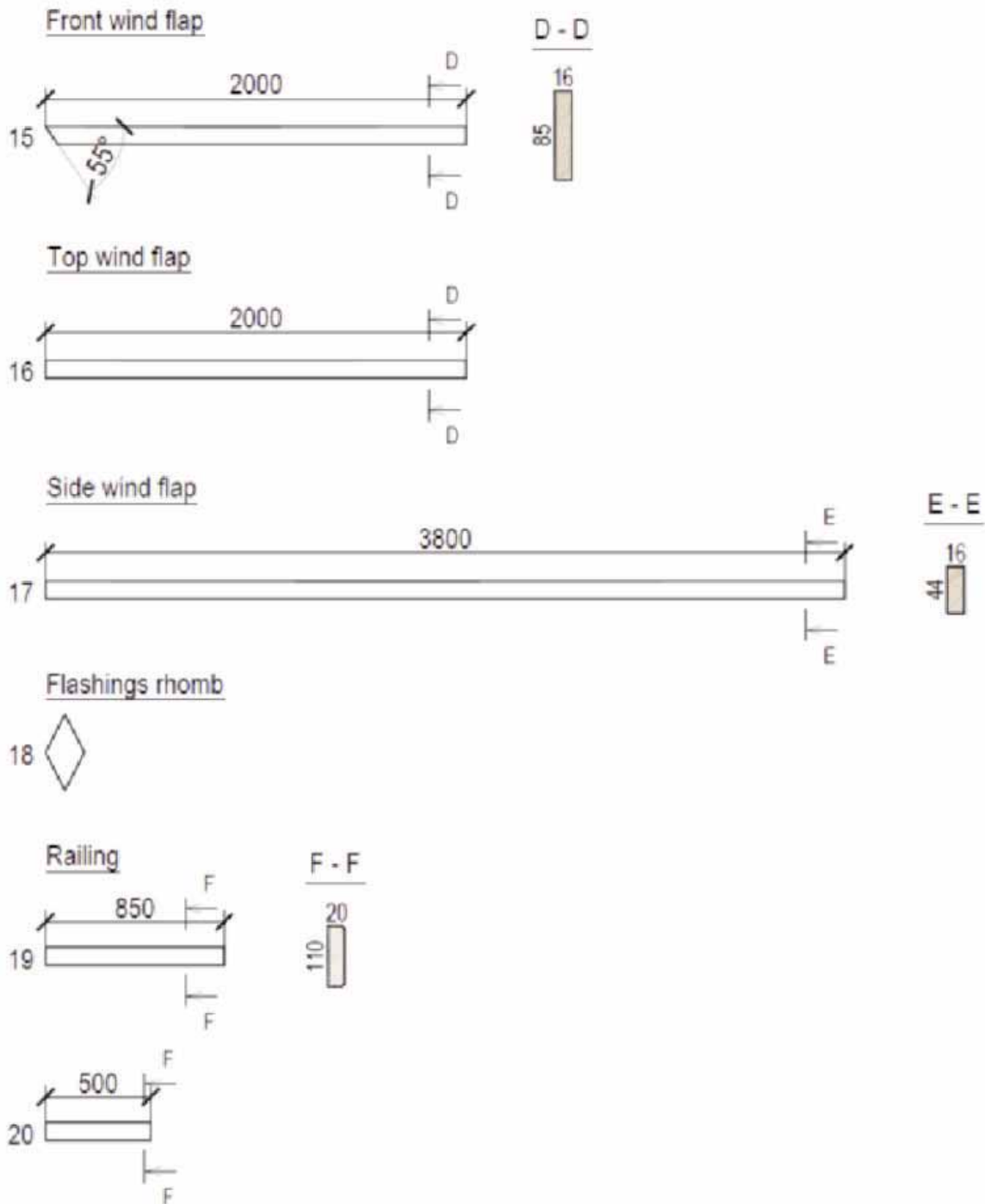



Congratulations on assembling your 9x9 Muskoka Cabin

Note: Our Sheds are shipped as unfinished products. If exposed to the elements, the western red cedar lumber will weather to a silvery-gray color. If you prefer to keep the cedar lumber looking closer to the original color, we suggest that you treat the wood with a good oil base wood stain. You may also wish to paint your new shed rather than stain it. In both cases we recommend that you consult with a paint and stain dealer in your area for their recommendations.

We hope your experience assembling your 9x9 Muskoka Cabin has been both positive and rewarding.

We value your feedback and would like to hear back from you on how well we are doing in the following areas:

1. Customer Service
2. On Time Shipping
3. Motor Freight Delivery
4. Quality of Materials
5. Assembly Manual
6. Overall Satisfaction.



Please call, write or email us at:

Outdoor Living Today

Canadian Address
9393 287th Street
Maple Ridge, British Columbia
Canada V2W 1L1

United States Address
P.O. Box 96
Sumas, Washington
USA 98295



The materials contained in this Assembly Manual may be downloaded or copied provided that ALL copies retain the copyright and any other proprietary notices contained on the materials. No material may be modified, edited or taken out of context such that its use creates a false or misleading statement or impression as to the positions, statements or actions.