



# 8x4 GardenSaver Garden Shed Single Door - Plywood Roof - Finger Jointed Assembly Manual

Thank you for purchasing an 8x4 GardenSaver - Single Door Shed. Please take the time to identify all the parts prior to assembly.

Stock Code: GS84-S-FJ-Plywood

Roof Area: 37.5 sqft

Please be aware that it is the customers' sole responsibility to acquire the necessary building permits and or obtain approval from their local county, municipality or HOA prior to purchasing. Generally, shed structures under 100 square feet do not require permits in most jurisdictions in the United States and Canada.

Revision #1.4  
Apr 20, 2022



- Snow load ratings vary by geographical location. If heavy or wet snowfall occurs, it is advisable to sweep snow off roof frequently.
- If the product is elevated, any structural and building code requirements are solely the customer's responsibility, and should be abided by.
- In areas with high or gusty wind conditions, it is advisable to install the structure securely to the ground.
- Have a regular maintenance plan to ensure screws, doors, windows and parts are tightly affixed.



Customer agrees to hold Outdoor Living Today and any Authorized Dealers free of any liability for improper installation, maintenance and repair.

In the event of a missing or broken piece, call the Outdoor Living Today Customer Support Line @ 1-888-658-1658 within 30 days of the delivery of your purchase. It is our commitment to you to courier replacement parts, free of charge, within 10 business days of this notification. Replacement parts will not be provided free of charge after the 30 day grace period.

All structures purchased from Outdoor Living Today are covered for a period of one year for defects in manufacturing and workmanship. Costs incurred for customer installations are not included.

Failure to use supplied parts included in this kit could result in poor product performance and may void your warranty. Please contact Outdoor Living Today's Customer Toll Free Line if you plan to deviate from our written instructions.

# What to do before my Shed arrives?



- Become familiar with this assembly manual and determine if you can complete the project yourself or will require a professional contractor.



- One helper is recommended to assist in constructing your shed. It generally takes two people two days to assemble a shed. If you're hiring a contractor, their rate should be in line with that duration of work.



- Clear the construction area and ensure a clear pathway for delivery when the freight company arrives. Remove all debris: roots, grass, rocks, etc.



- Excavate the site. Contact your local utilities company to ensure there are no gas or electric lines buried in the area before digging.



- Decide on the type of foundation you will be using:
  - Concrete slab, or
  - 4-6 inches of crushed gravel with paver stones or 4x4 stringers.

You can find the footprint for your shed on Page 3 of your Assembly Manual.



- If doing the assembly yourself, have all the necessary tools ready to go and in working condition. A list of required tools can be found after the parts list.

# Foundation Types for 8x4 Garden Shed

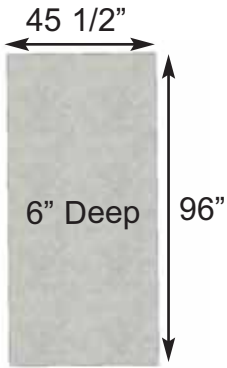

**Concrete Foundation**

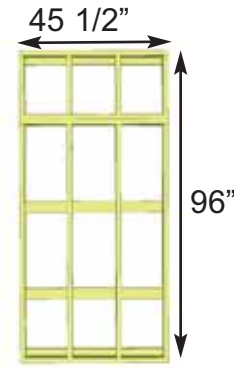

**Floor Frame**



**Completed Foundation**

**Concrete Slab Foundation:**

- Slab must be at least the same size as assembled floor frame (45 1/2" x 96") or larger.
- 6" Deep foundation.
- 0.6 Cubic Yards of concrete required.
- A concrete slab will have the longest durability out of your foundation options.

**Once level, a concrete slab is the easiest surface to build on.**

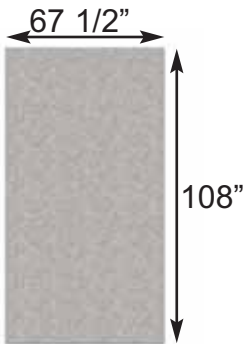

**Gravel Foundation**

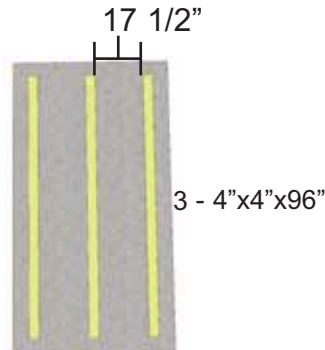

**Gravel Foundation with treated stringers**



**Completed Foundation**

**Gravel with 4x4 Pressure Treated Stringers:**

- Excavate at least 6" deep, and 6" wider than floor frame on each side.
- 1.0 Cubic Yards of gravel required, approximately 9 wheelbarrows.
- 3 - 4x4 Pressure Treated Stringers 8' long required.
- Evenly spaced, with one at each end of floor frame.

**Saves money on materials, easy to level and work with.**

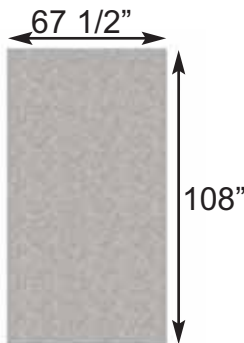

**Gravel Foundation**

15 Patio Stones



**Gravel Foundation with Patio Pavers**



**Completed Foundation**

**Gravel with Patio Paver Stones:**

- Excavate at least 6" deep, and 6" wider than floor frame on each side.
- 1.0 Cubic Yards of gravel required, approximately 9 wheelbarrows.
- 15 patio pavers (8" x 8" or larger).
- Center patio paver stones underneath floor runners and underneath seams in floor joists.

**Patio paver stones are widely available from most landscape stores.**

Thank you for purchasing our 8x4 GardenSaver -Single Door Shed.  
Please take the time to identify all the parts prior to assembly.

## Parts List:

### A. Floor Section

- 1 - 45 1/2" x 75" - **Large Floor Frame** (2 Joists unattached)
  - 1 - 45 1/2" x 21" - **Small Floor Frame** (2 Joists ATTACHED)
  - 2 - 1 1/2" x 3 1/2" x 72" - **Floor Joists**
- (Steps 1 - 3)

- 5 - 1 1/2" x 3 1/2" x 45 1/2" - **Floor Runners**
- (Steps 4 - 6)

- 1 - 5/8" x 45 1/2" x 75" - **Plywood Flooring**
  - 1 - 5/8" x 45 1/2" x 21" - **Plywood Flooring**
- (Steps 7 - 8)

### B. Wall Section

- 4 - 1 1/2" x 2 1/2" x 45 1/2" - **Wall Plates**
  - 4 - 45 1/2" x 75" - **Solid Wall Panels**
  - 1 - 45 1/2" x 75" - **Window Wall Panel**
  - 1 - 12" x 73" - **Narrow Wall Panels**
- (Steps 9 - 18)

- 1 - 2" x 3 3/8" x 45 1/2" - **Door Header - (Dado top edge)**
  - 2 - 3/4" x 3 3/8" x 73" - **Door Jambs - Vertical**
- (Steps 19 - 21)

- 2 - **Top Triangular Siding Pc for Angle Wall Extensors (L/R)**
  - 2 - 45 1/4" - **Angle Wall Extensors (L/R)**
  - 2 - 9" x 45 1/2" - **Wall Extensors**
- (Steps 22 - 28)

- 1 - 3/4" x 3 1/2" x 70" - **Horizontal Wall Cleat**
  - 1 - 3/4" x 3 1/2" x 21" - **Horizontal Wall Cleat**
- (Step 29)

### C. Rafter & Roof Section

- 6 - 1 1/2" x 2 1/2" x 54" - **Rafters**
  - 1 - 3" x 2 1/2" x 54" - **Rafter**  
- angle cut ends (3/4" cleats attached on sides)
  - 2 - 1/2" x 3 1/2" x 48" - **Front Soffit**
  - 2 - 1/2" x 3 1/2" x 48" - **Rear Soffit**
- (Steps 31 - 36)

- 1 - 5/8" x 4" x 53 3/4" - **Center Plywood for Roof**
  - 2 - 5/8" x 48" x 21 3/4" - **Small Plywood for Roof**
  - 2 - 5/8" x 48" x 32" - **Large Plywood for Roof**
- (Steps 37 - 42)

- 2 - 3/4" x 3/4" x 51" - **Rafter/Facia Nailing Strips**
- (Step 43)

### D. Miscellaneous Section

#### (Skirting, Trim, Door, Facia & Misc. Parts)

- 6 - 1/2" x 4 1/2" x 45 1/4" - **Bottom Skirting** (Bevel Siding)
- (Steps 44 - 47)

- 8 - 3/4" x 2 1/2" x 36" - **Corner Filler Trims**
  - 2 - 3/4" x 2 1/2" x 10" - **Front Center Corner Filler Trims**
- (Steps 48 - 50)

- 2 - 1/2" x 5 1/2" x 79" - **Rear Corner Trims**
  - 2 - 1/2" x 5 1/2" x 88 3/4" - **Front Corner Trims**
  - 2 - 1/2" x 2 1/2" x 80" - **Side Rear Corner Trims**
  - 2 - 1/2" x 2 1/2" x 88 3/4" - **Side Front Corner Trims**
  - 1 - 1/2" x 2 1/2" x 79" - **Rear Middle Trim**
- (Steps 51 - 54)

- 2 - 1/2" x 3 1/2" x 77 1/2" - **Vertical Door Trims**
  - 1 - 1/2" x 2 1/2" x 46 3/4" - **Horizontal Door Trim**
  - 1 - 1/2" x 3 1/2" x 8 3/4" - **Front Middle Trim**
- (Steps 55 - 57)

- 1 - 31 1/2" x 72" - **Full Door**
- (Steps 58 - 60)

- 2 - 1/2" x 4" x 54 1/8" - **Side Facia** (Angle Cut Ends) - reverse
  - 4 - 1/2" x 4" x 50 1/2" - **Front and Rear Facia**
- (Steps 61 - 63)

- 2 - **Detail Facia Plates** (4" high)
- (Step 64)

- 1 - 1/2" x 1/2" x 32" - **Upper Horizontal Door Stop**
  - 4 - 1/2" x 1/2" x 36 1/4" - **Vertical Door Stops**
- (Steps 65 - 66)

- 1 **Aluminum Window Insert**
- (Steps 67 - 68)

#### Window Trim Pkg

- 1 - 24 1/16" angle cut / 3 - 23" Straight Cut - **Window Trim Kit**
- (Step 69)

- 1 **Flower Box Kit**
- (Step 70)

- 1 - 45 1/4" - **Extra Piece of Bevel Wall Siding** - Use if wall panel siding is damaged or to shim floor or door.

#### Optional Pieces - When Door configured on end.

- 1 - 1 1/2" x 3 3/8" x 73" - **Optional Door Jamb**
  - 1 - 1/2" x 2 1/2" x 42 1/2" - **Optional Horizontal Door Trim**
  - 1 - 1/2" x 2 1/2" x 88 3/4" - **Optional Front Middle Trim**
- (Optional - Steps 77 - 80)

Note: All Trim, Facia and Bottom Skirting pieces will be positioned rough face out when installed.

# 8x4 GARDENSAVER-Single Door - Plywood Roof- HARDWARE PACKAGE

## Hardware Kit (Provided)

3"  x 10

4"  x 6

2 1/2"  x 140

1 1/2"  x 240  
Finishing Nail

1 1/4"  x 200

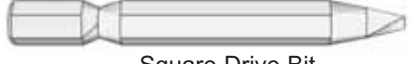
 x 1  
Square Drive Bit

2"  x 22  
Black Headed

3/4"  x 12  
Black Headed



Tee Hinge x 3



Door Handle x 1



Drop Latch



90° Metal Bracket x 8

## Tools Required (Not Provided)



Hammer



Screw Gun/Drill



Tape Measure



Wood Clamp



Utility Knife



Level



Pliers



Ladder



Caulking



1/8" Drill Bit

## Safety Equipment Required (Not Provided)



Safety Glasses



Work Gloves

## Before/During Assembly:

- 1.) Paint each face and edge of your plywood floor with a latex exterior paint.
- 2.) Caulk wall seams if gaps appear.
- 3.) Caulk around window framing.
- 4.) Caulk perimeter between floor plywood and bottom wall plate.
- 5.) Caulk channels in lap siding at the top of your door above the trim, just a drop in each channel.
- 6.) Caulk edge of door threshold (if applicable).
- 7.) Optional: Install a Sill Gasket between floor runners and foundation.
- 8.) Optional: Install an 8" strip of roofing paper below Cedar Ridge Caps for Cedar Roof Sheds.

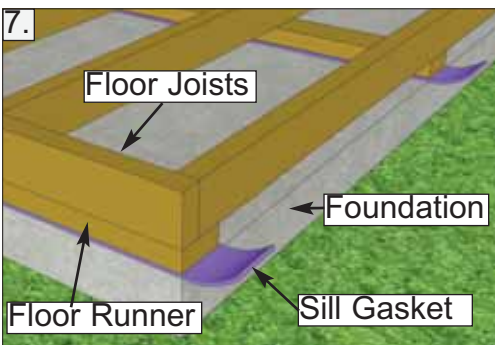
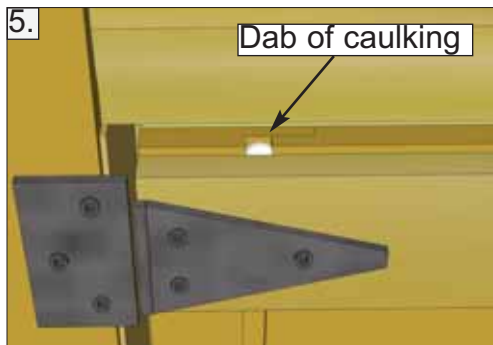
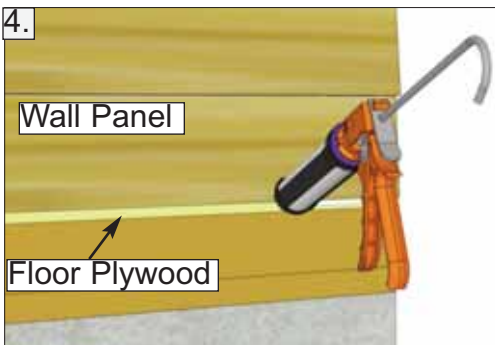
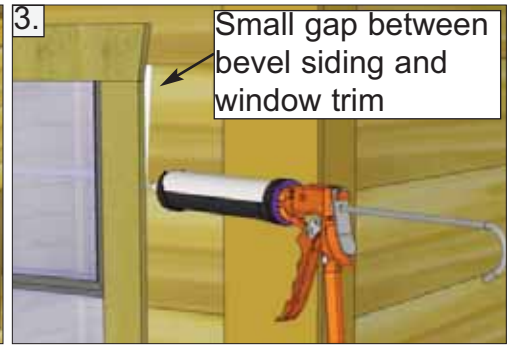
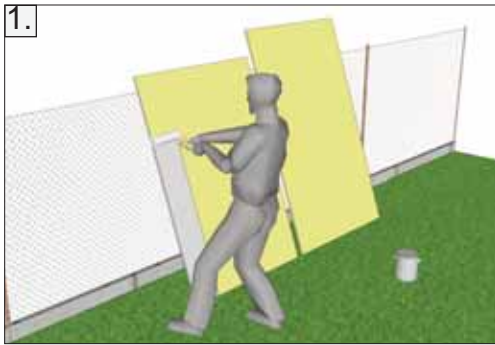

## Routine Maintenance:

- Routinely check all fasteners are tight (ex. Door Hinges, Nails)
- Brush off dirt from walls.
- Brush off snow from roof regularly.
- Routinely remove needles and leaves from roof.

## Painting/Staining

- Your cedar shed, if left untreated, will weather to a silvery grey colour.
- Painting or staining your structure is highly recommended and will prolong the life of your shed.
- You do not need to wait to paint or stain your shed, the wood in your kit has been dried and can be stained or painted immediately.
- Consult your local paint store for the best paint or stain for cedar.
- Optional: stain the inside of your shed. (Note: this will remove the fresh cedar smell.)

# A. Floor Section

Exploded view of all parts necessary to complete Floor Section. Identify all parts prior to starting. Note: Floor Footprint is 96" wide x 45 1/2" deep.

## Exploded Floor Section

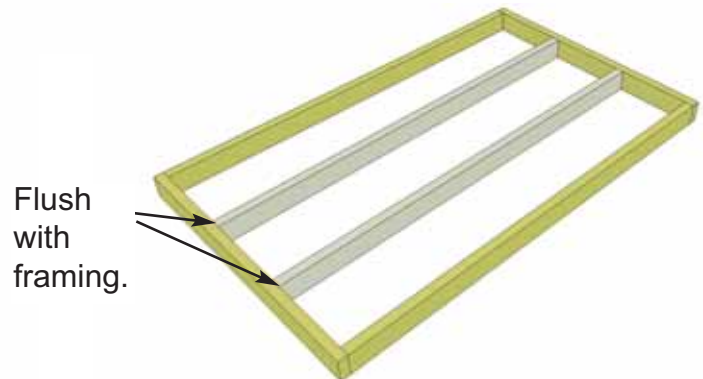
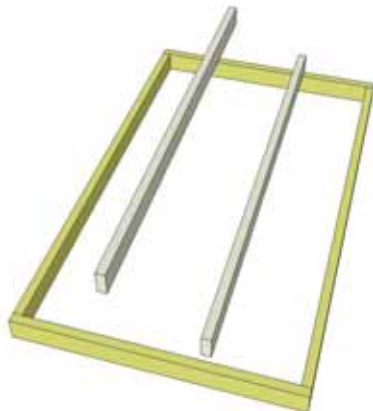
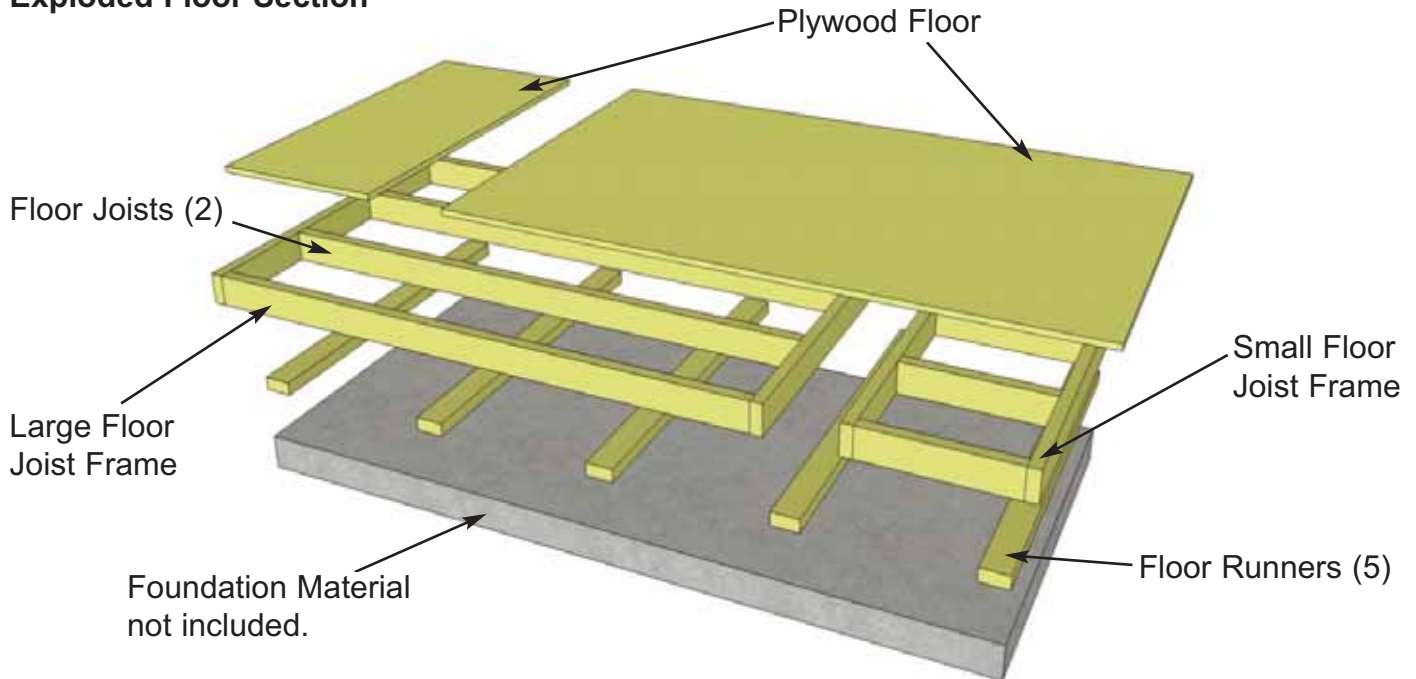

**1.** Lay out **Large Floor Joist Frame** and **2 Floor Joists** (1 1/2" x 3 1/2" x 71 7/8") as illustrated above. Position Joists equally in Floor Joist Frame. Use **Small Floor Joist Frame** as a template to determine joist position. Position Joist so flush with framing.

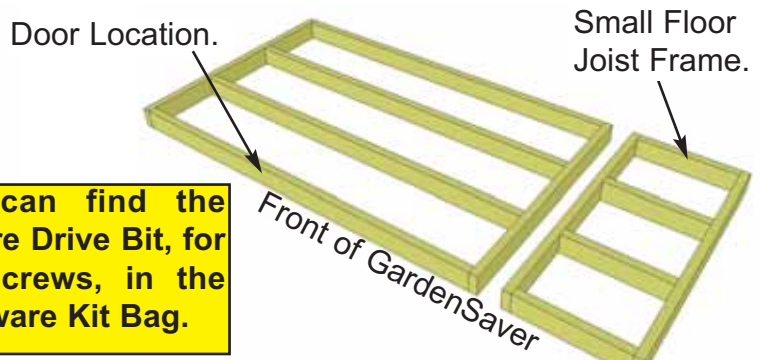
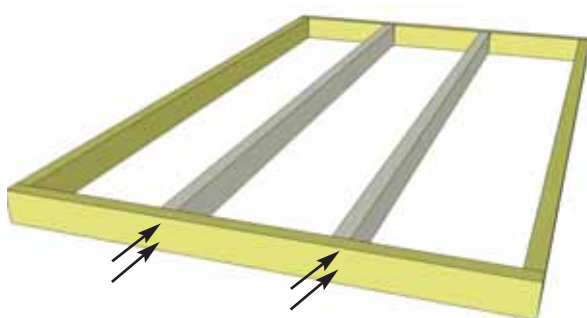

You can find the Square Drive Bit, for the screws, in the Hardware Kit Bag.

**2.** When correctly positioned, attach each Joist with **4 - 2 1/2" Screws** (2 per end). **You can find the Square Drive Bit for the screws in with the Hardware Kit Bag.**

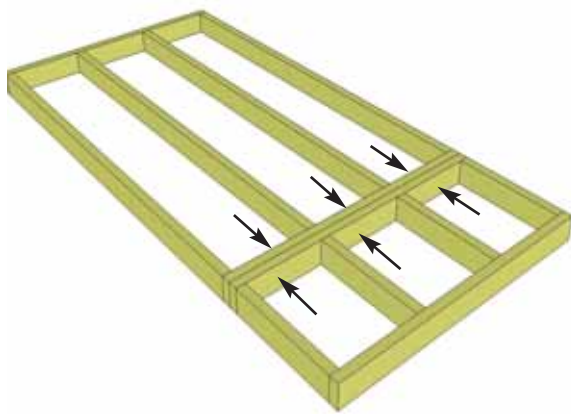

**3.** With Floor Joist Frames positioned together flush, attach with **6 - 2 1/2" Screws**.

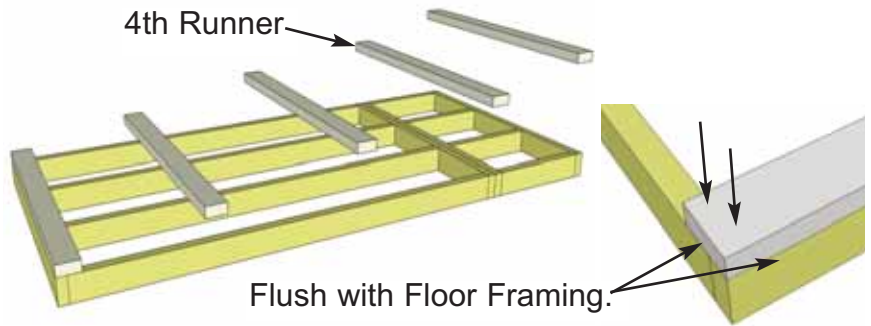

**4.** Position and attach **Floor Runners** (1 1/2" x 3 1/2" x 45 1/2") to completed floor frames with **6 - 2 1/2" Screws** per Runner. Make sure Runners are flush with outside of floor framing but not overhanging. Make sure 4th Runner is placed equally over seam where floor frames meet.

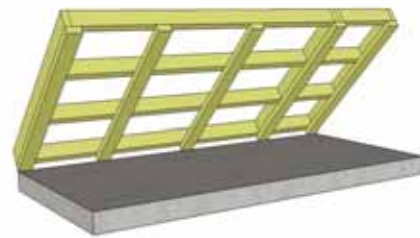
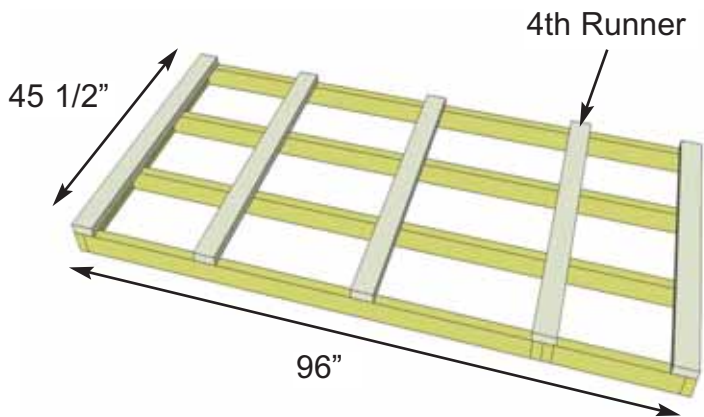

**5.** With Floor Runners attached, carefully flip the floor over and place on your foundation. **Caution** - you may need 2 people to assist you. Be careful when laying floor down not to bend or twist floor. **Note:** The floor will be flipped over and floor runners will sit on your foundation. It is important to note that having a level foundation is critical. Choosing a foundation will vary between regions. Typical foundations can be concrete pads or patio stones positioned underneath the floor runners.

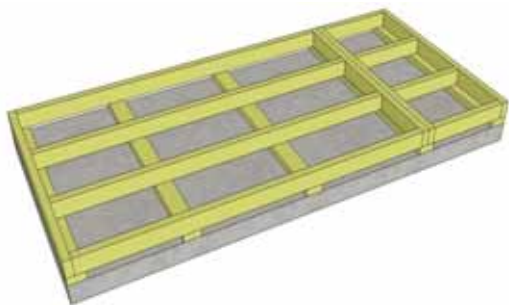

**6.** When in place, level floor completely before proceeding.

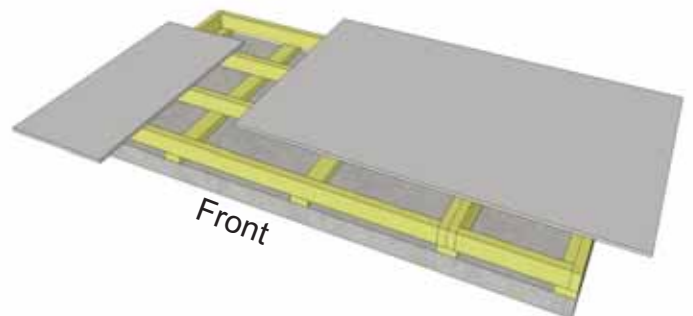

**7.** Position **Plywood Floor** pieces (2) on top of completed floor joists.



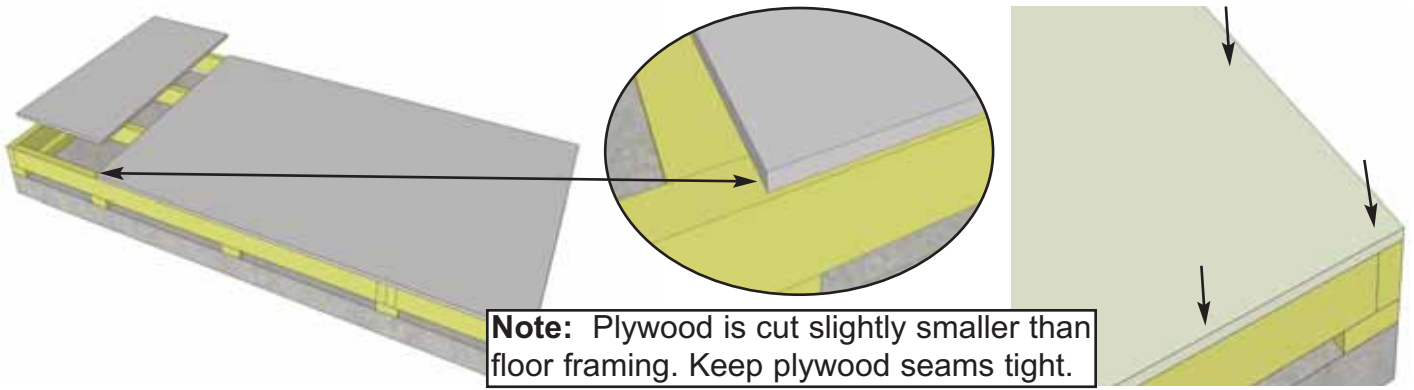

**8.** Position Plywood so it sits almost flush with outside of floor joist framing (see **Note**). When correctly positioned, attach to all floor joists with approximately **24 - 1 1/4" Screws**. Use screws every 16".

## B. Wall Section

**Exploded view of all parts necessary to complete the Wall Section. Identify all parts prior to starting.**

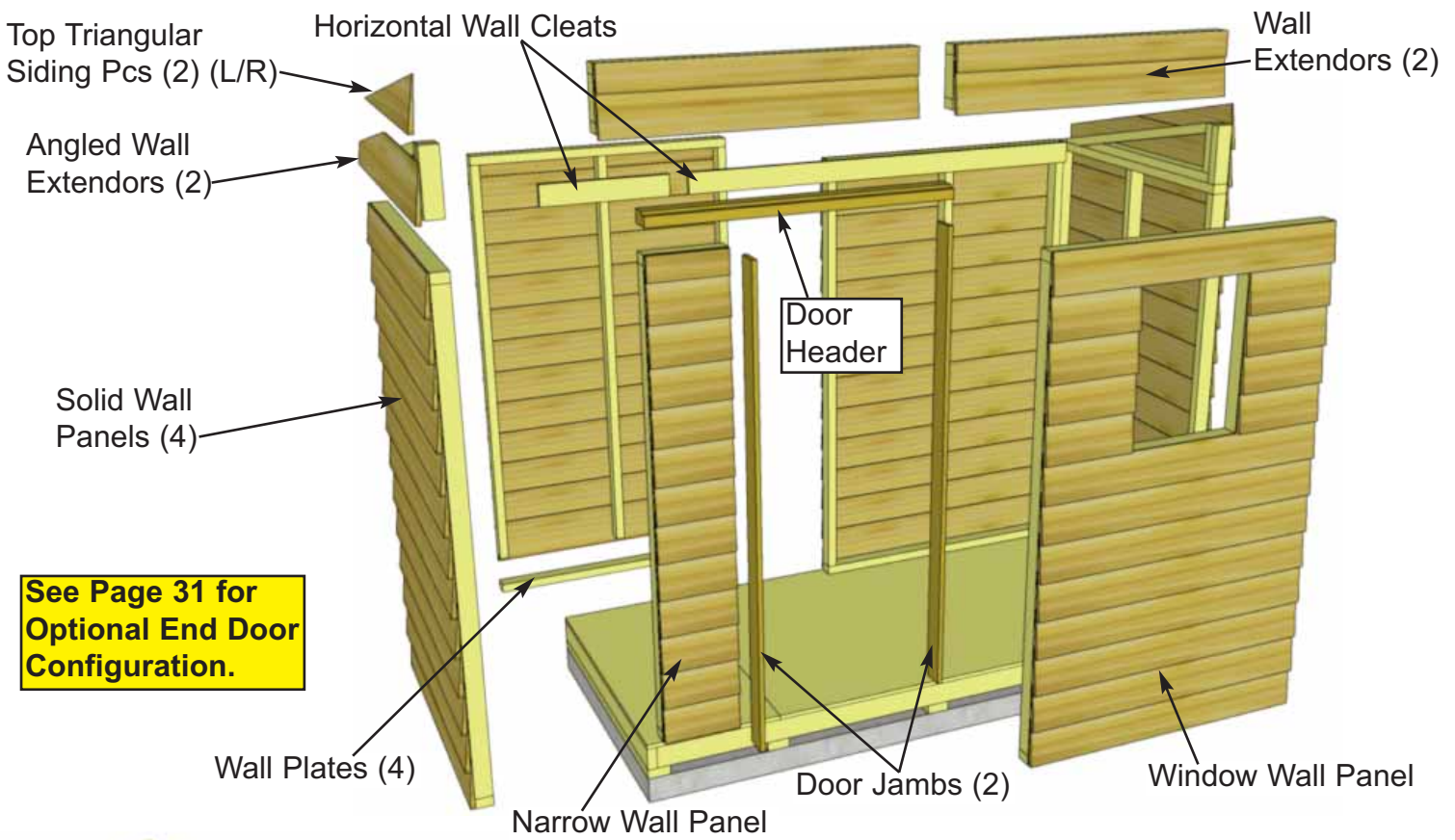

**See Page 31 for Optional End Door Configuration.**

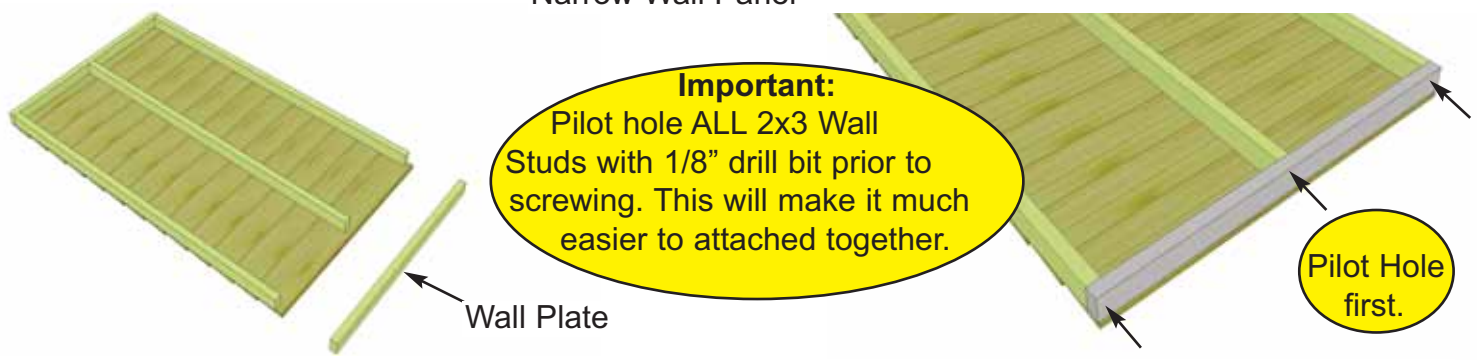

**9.** Locate 4 **Solid Wall Panels** and 4 **Wall Plates** (1 1/2" x 2 1/2" x 45 1/2"). Attach Plates to bottom of studs of each wall panel with **3 - 2 1/2" Screws**. Position so plates are flush with framing.

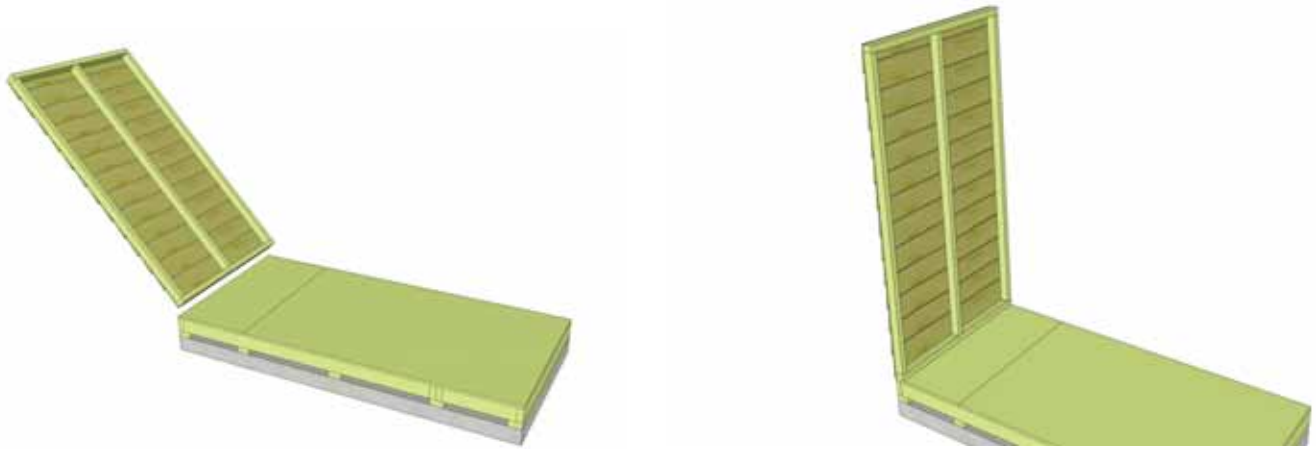

**10.** Starting on side, position a **Solid Wall Panel** on top of plywood floor. The Wall Panel bottom framing will sit flush with floor framing. Wall siding will overhang the floor. **Important:** Make sure all walls are aligned in their upright position. If not, water may leak into your shed. Unsure if panel is facing up or down? Recently attached Bottom Plate is on bottom of panel.

Do not align wall siding to floor. Align wall plate to outside of plywood floor.

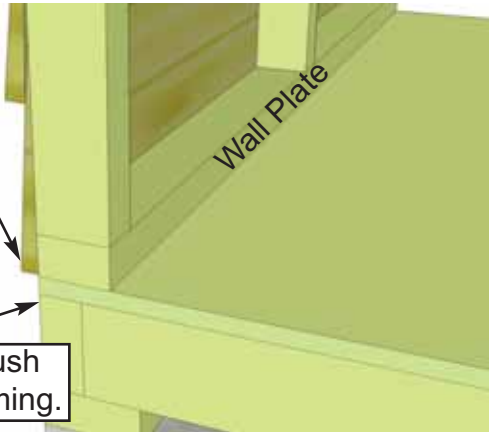

Wall Plate Flush with floor framing.

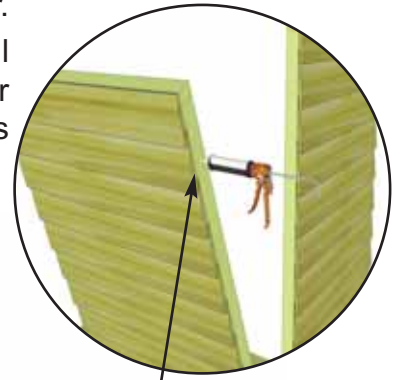

**Optional -** Caulking seams will help prevent moisture from entering your shed. Caulking not included in kit.

**11.** Outside 2x3 framing of wall panel should be flush with outside of floor framing when properly aligned. **Note:** Do not align wall siding to floor. Align wall plate to outside of plywood floor. When positioned correctly, locate 2nd Solid Wall Panel and place in corner.

**Do Not Attach Walls To Floor until Step 30.**

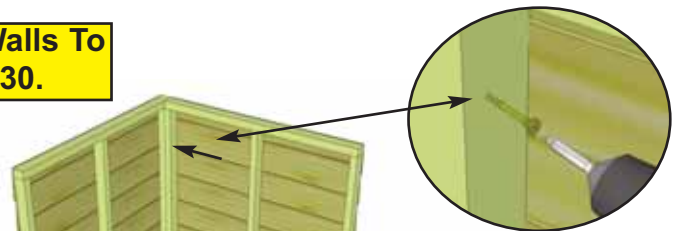

**Pilot Hole first.**

**12.** Butt both vertical wall studs of side and rear walls together and attach with **3 - 2 1/2" Screws**. Screw at the bottom, middle and top of stud to secure properly. Have helper push wall framing together while securing to ensure tight fit. **Note: Drill pilot holes in studs to prevent splitting.**



Pilot Hole first.

**13.** With the corner wall attachment complete, position the second rear wall panel in place so bottom 2x3 wall framing is sitting flush with outside floor framing. Wall siding should overhang floor by approximately 3/4". When positioned correctly, attach both wall panel studs together as per **Step 12** with **3 - 2 1/2" Screws**.

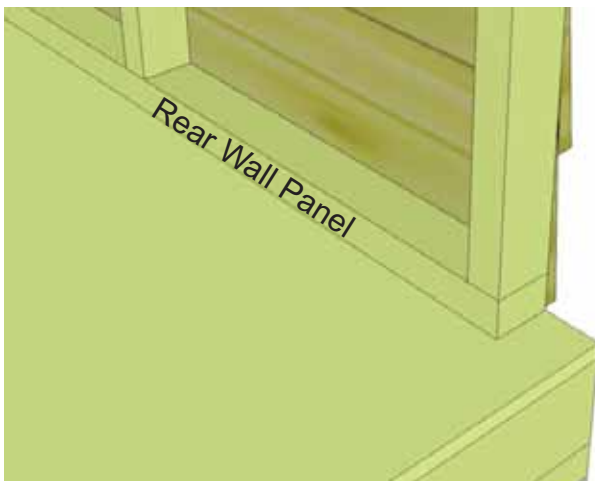

**Do Not Attach Walls To Floor until Step 30.**



**14.** With Rear Wall Panel in place, position other side wall panel on floor as per **Step 10 & 11**.



Pilot Hole first.



**15.** Secure side wall panel to rear wall panel as per **Step 12**. Next, locate the **Narrow Wall Panel** and position in front.

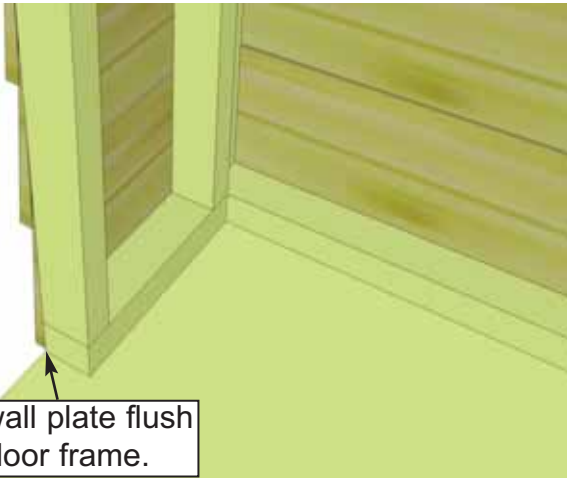

2x3 wall plate flush with floor frame.

**16.** Once again position the 2x3 wall plate so it sits flush with floor framing and siding overhangs.  
**Note:** Narrow Wall Panel is only 73" high.

Pilot Hole first.

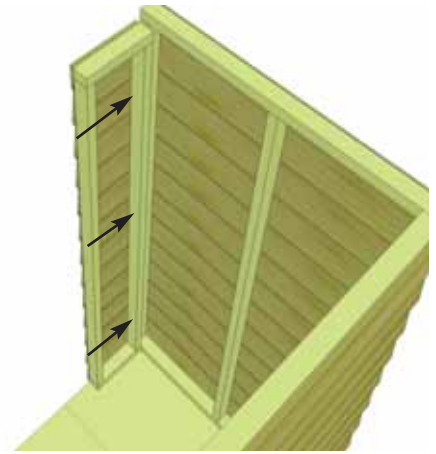

**17.** When correctly positioned, secure Narrow Wall Stud to Side Wall Stud with **3 - 2 1/2" Screws**.

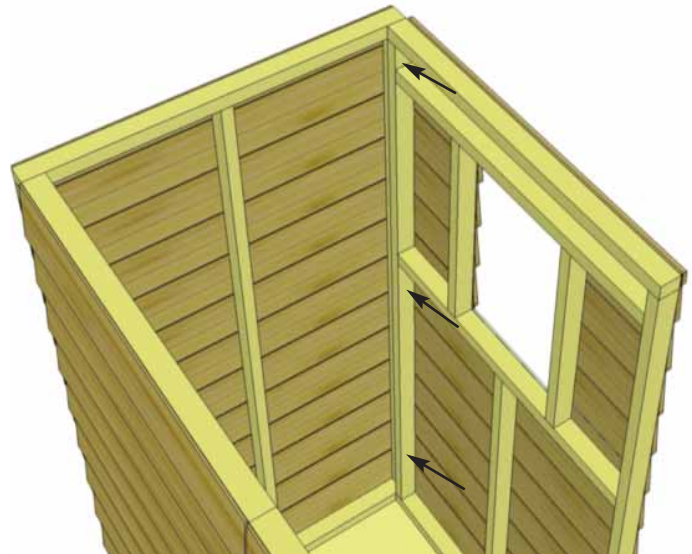
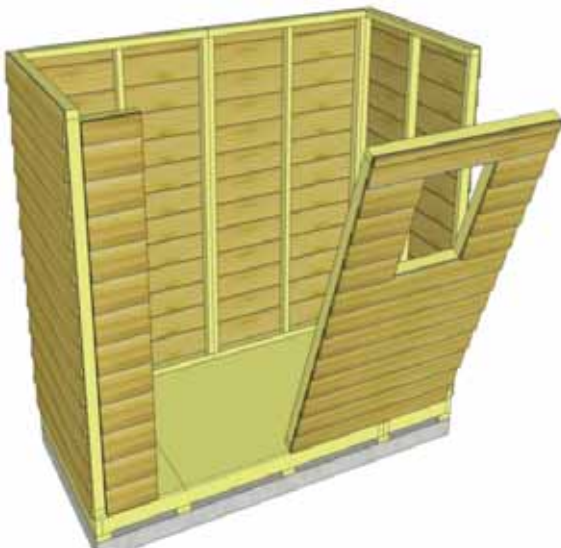

**18.** Align front corner Window Wall Panel as per **Steps 11 & 12**, using **3 - 2 1/2" Screws** to secure wall studs together.

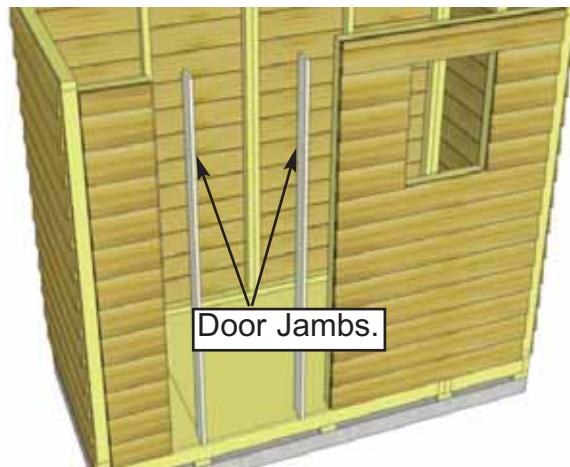

Door Jambs.

**19.** Locate **Door Jambs** (2 @ 3/4" x 3 3/8" x 73") and place on wall studs to either side of door opening.

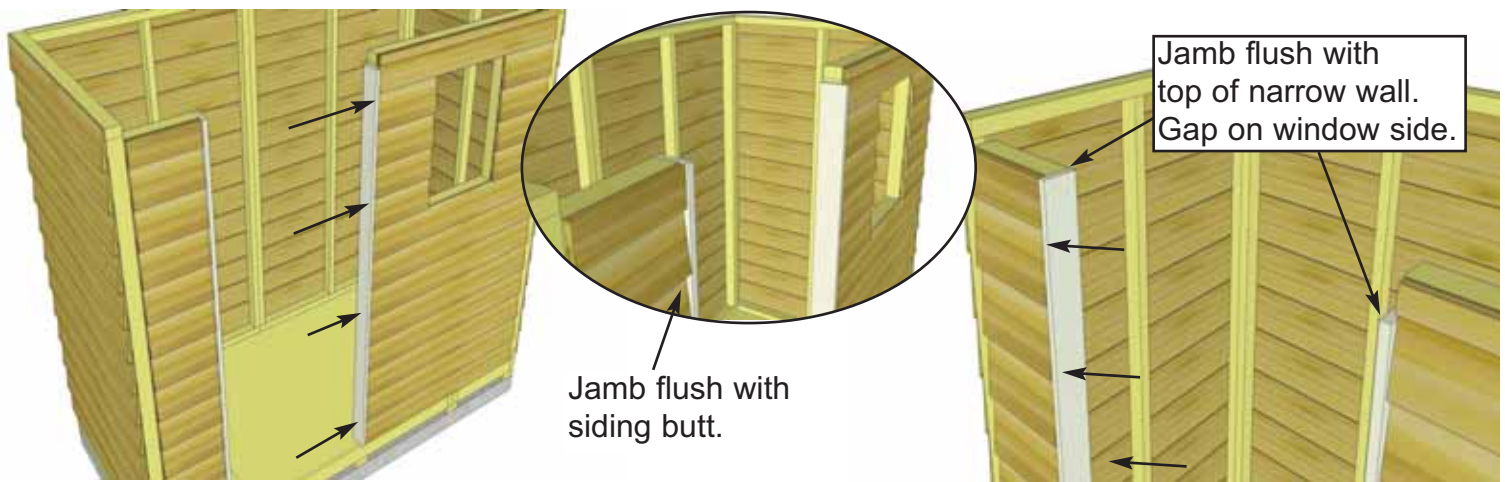

**20.** Position Door Jambs flush against narrow and window wall studs and tight to floor. The Jamb is 3 1/2" wide and will sit flush to outside of wall siding. When positioned correctly, secure Jambs using 4 - 2 1/2" Screws.

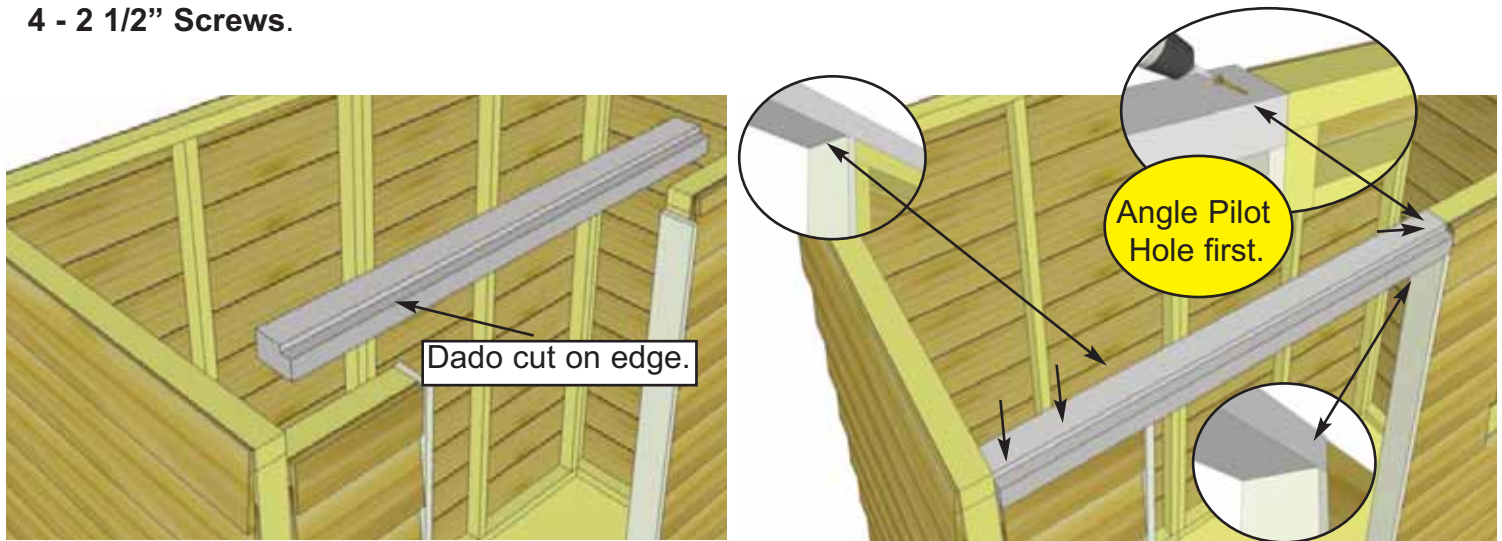

**21.** Position and attach the **Door Header** to top of Narrow Wall framing and against window wall framing resting on top of door jambs. Header should sit flush on Door Jambs. Attach with 4 - 2 1/2" Screws. On window side, screw about 1" from end of header at angle into window wall framing. Pilot hole first.

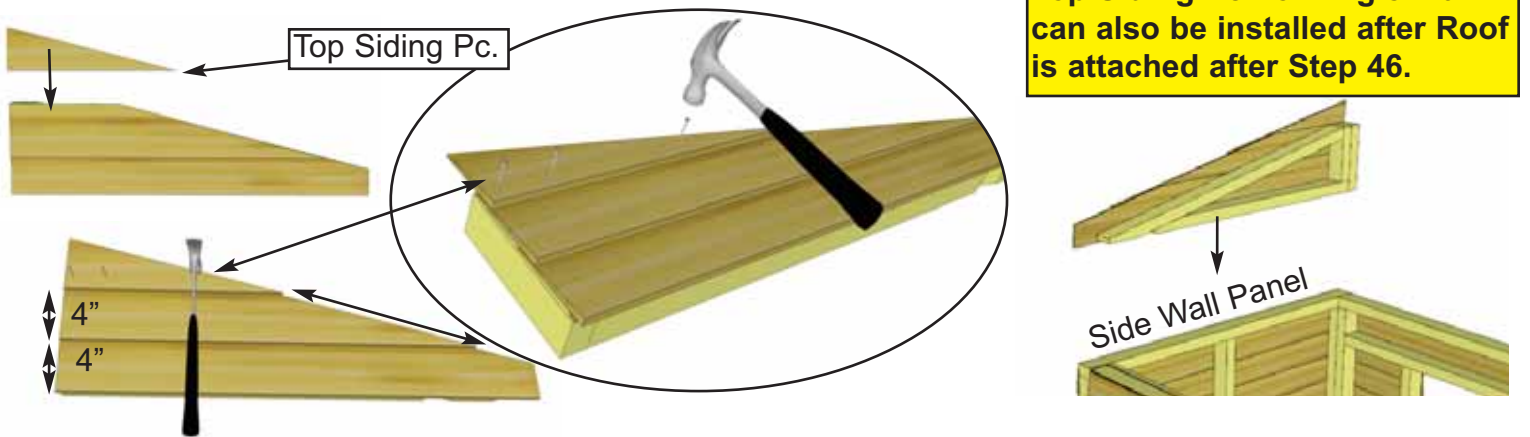

**22.** Locate an **Angled Wall Extendor** and **Top Siding Piece for Angled Wall Extendor (L/R)**. Position top siding on wall extendor and align as shown above. Attach with 3 - 1 1/2" Finishing Nails to top wall framing. There are left/right top siding pieces. Use rough surface side out. Place finished wall extendor on side wall panel frame. Complete both sides now. **Note:** Bottom siding of wall extendor will overhang and cover siding of side wall.

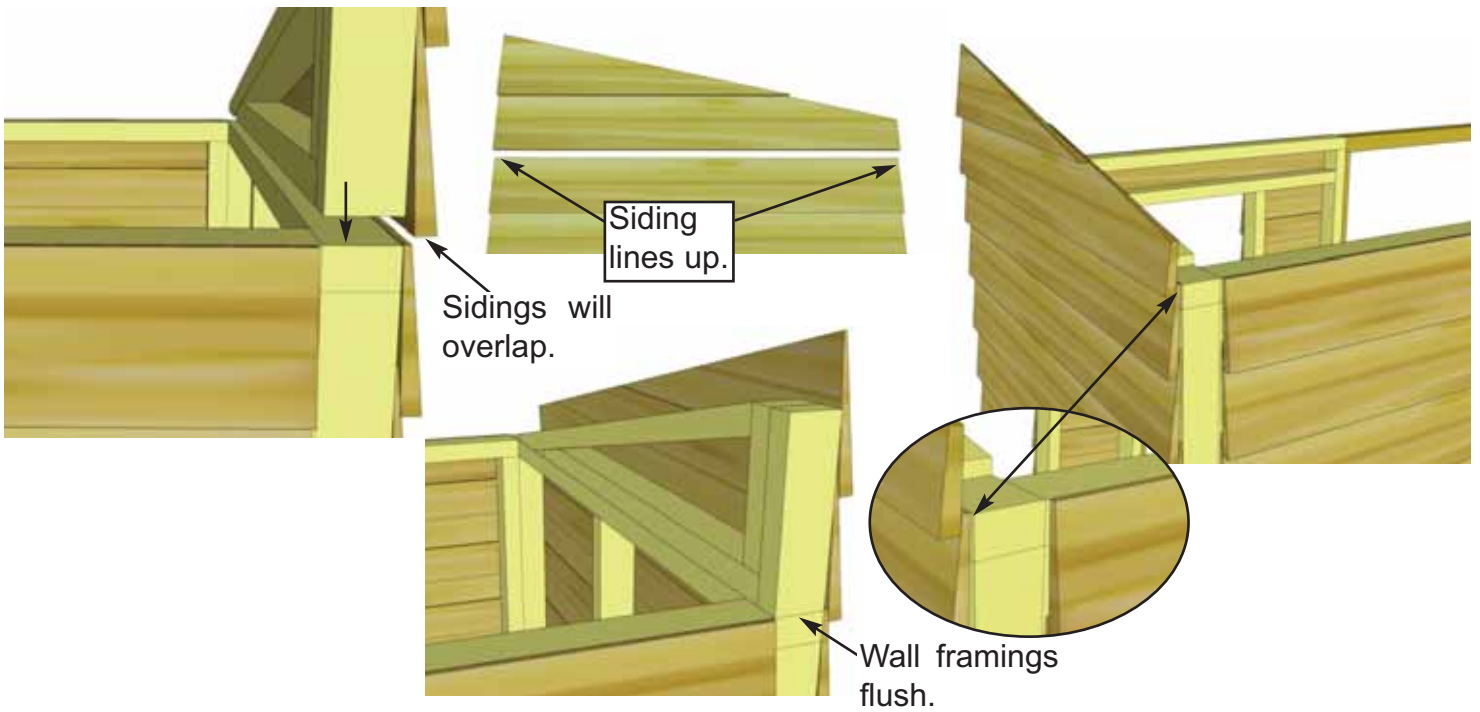

**23.** Align wall framing of Angled Wall Extensor and Side Wall so they are flush at the back. The siding for both walls should also align evenly from front to back.



**24.** With Angled Wall Extensor and Side Wall aligned correctly, secure together from the inside with 4 - 2 1/2" Screws.



**25.** Complete opposite Angled Wall Extensor positioning and attachment as per **Steps 23 & 24.**

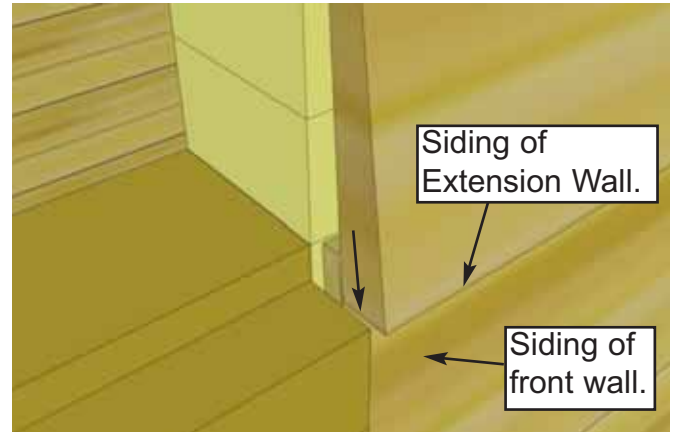
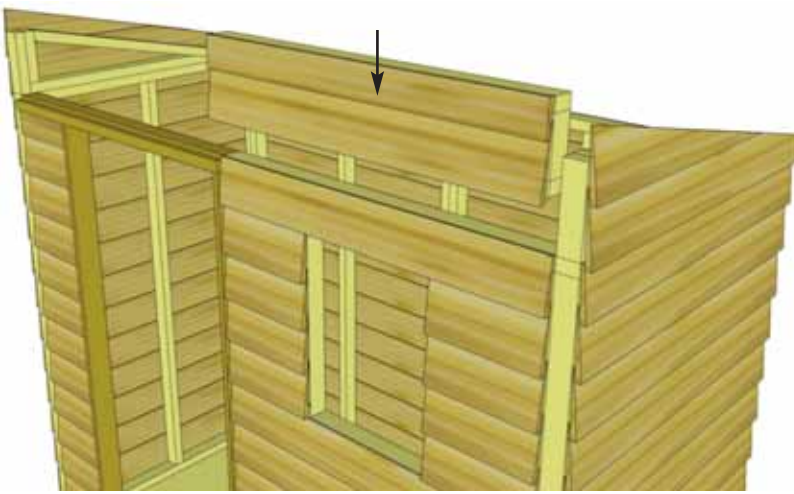

**26.** Locate one **Wall Extendor** and place on front window wall panel with siding of extendor overlapping that of the front window wall.

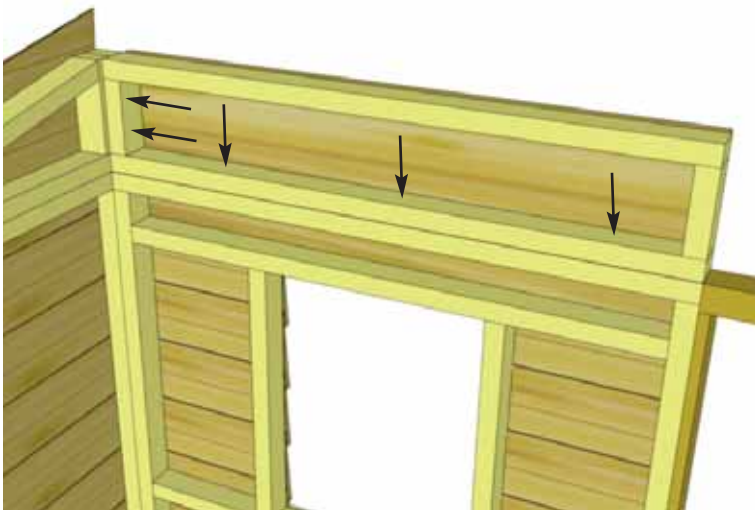

**27.** With 2x3 wall framing aligned, attach Wall Extendor to both the Angled Wall Extendor framing and the front window wall framing with **5 - 2 1/2" Screws**.

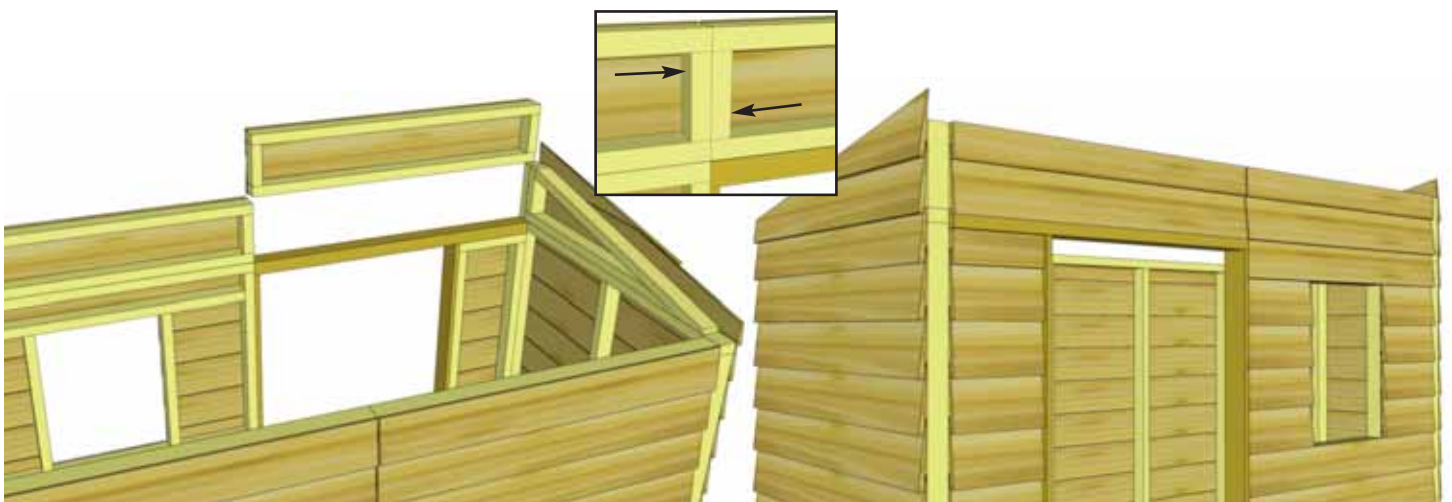

**28.** Position and secure 2nd Wall Extendor Panel as per **Steps 26 & 27**. Additionally, attach to first Extendor with **2 - 2 1/2" Screws**.

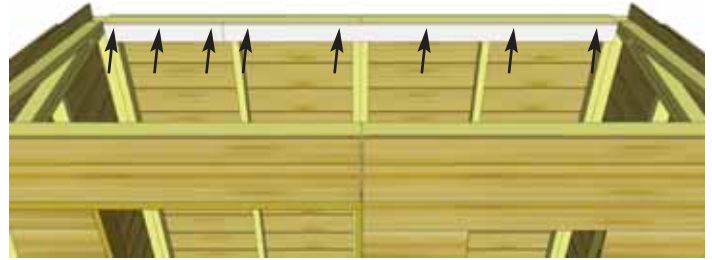
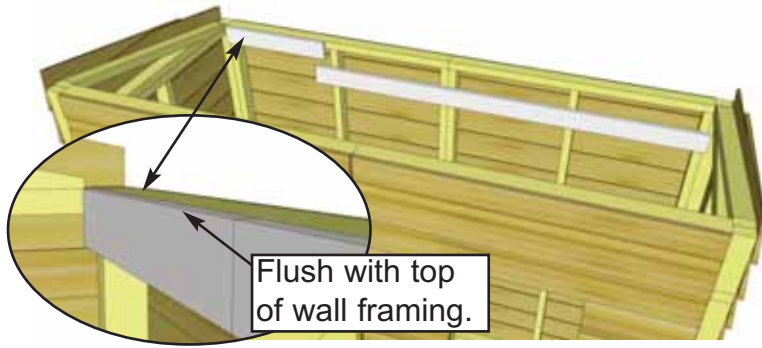

**29.** Align **Horizontal Wall Cleats** (1 @ 3/4" x 3 1/2" x 70", 1 @ 3/4" x 3 1/2" x 21") flush with top of Rear Wall framing. To help strengthen the Rear Walls, there is a short and a long wall cleat which meet off-center from the seam between walls. Attach Cleats with **8 - 1 1/4" Screws**.

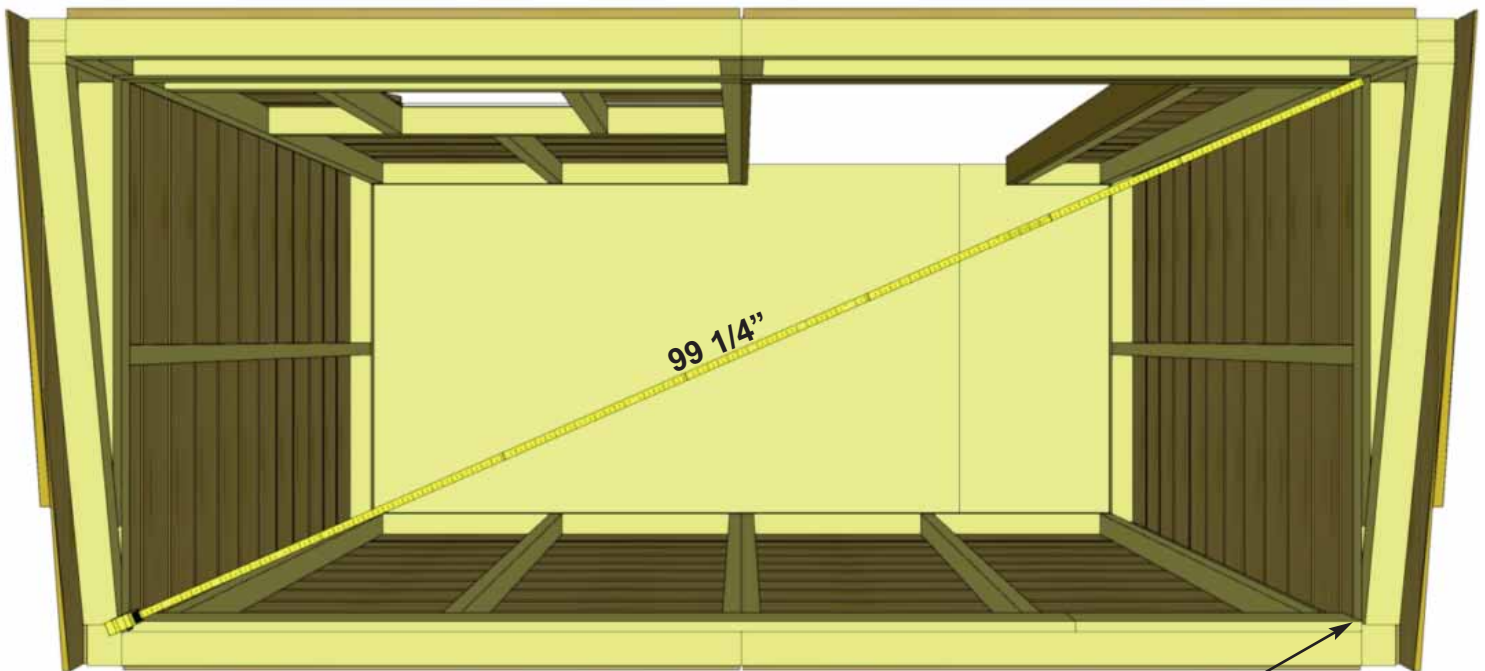

**Advice:** Prior to fastening walls and installing rafters, take time to confirm your walls are level, square and plumb.

Measure diagonal at top and bottom of walls corner-to-corner. This should be approximately 99 1/4". More importantly, if measurements are not within 1/4", your walls are not square. Adjusting now will make it easier to install roof section.

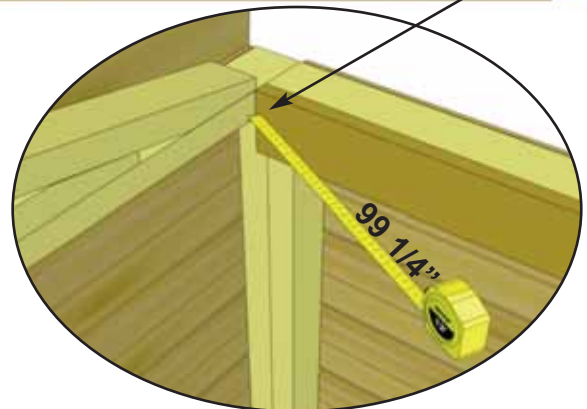



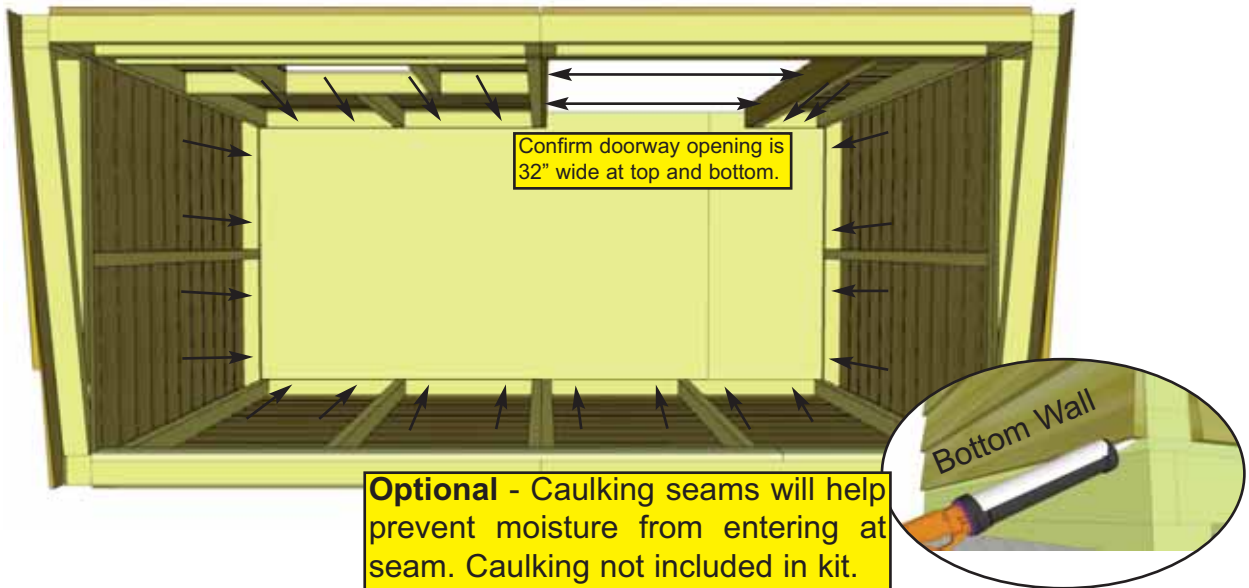

**30.** To complete Wall Section, attach bottom 2x3 wall plates to plywood floor with **22 - 2 1/2" Screws**. Confirm Doorway opening is 32" wide. Prior to securing, make sure wall panels are aligned correctly on the floor. Refer to **Step 11**. Wall siding should overhang floor while 2x3 wall plates should sit flush with floor.

## C. Rafter and Roof Section

Exploded view of all parts necessary to complete the Rafter and Roof Section. Identify all parts prior to starting.

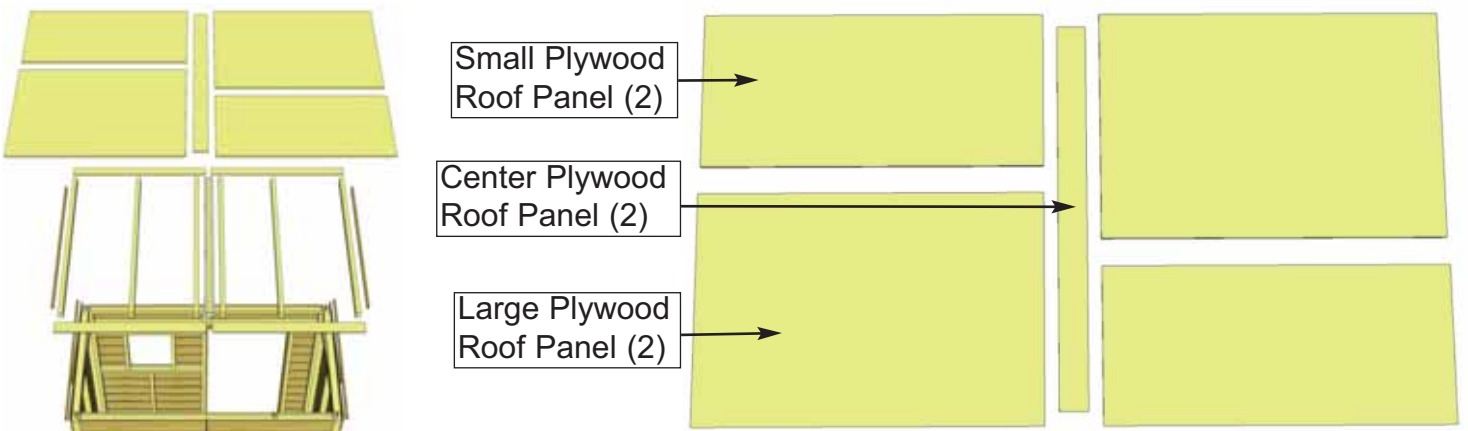
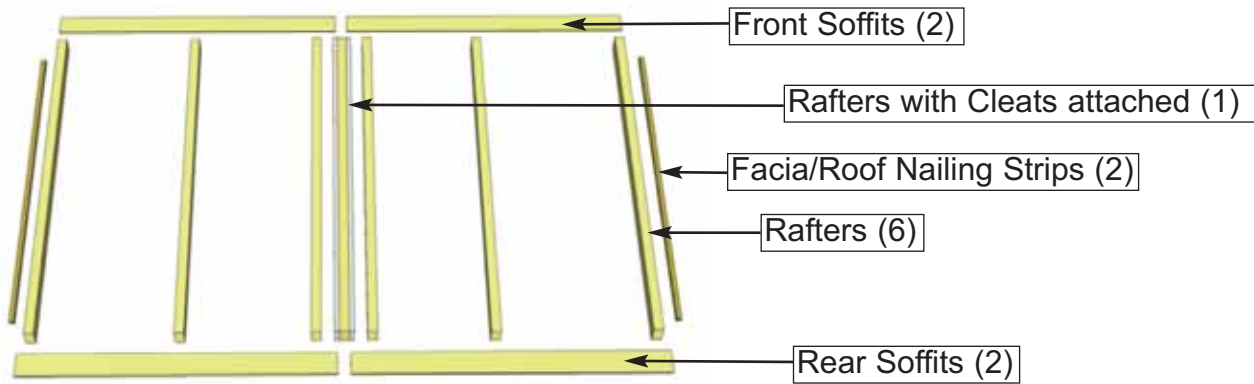

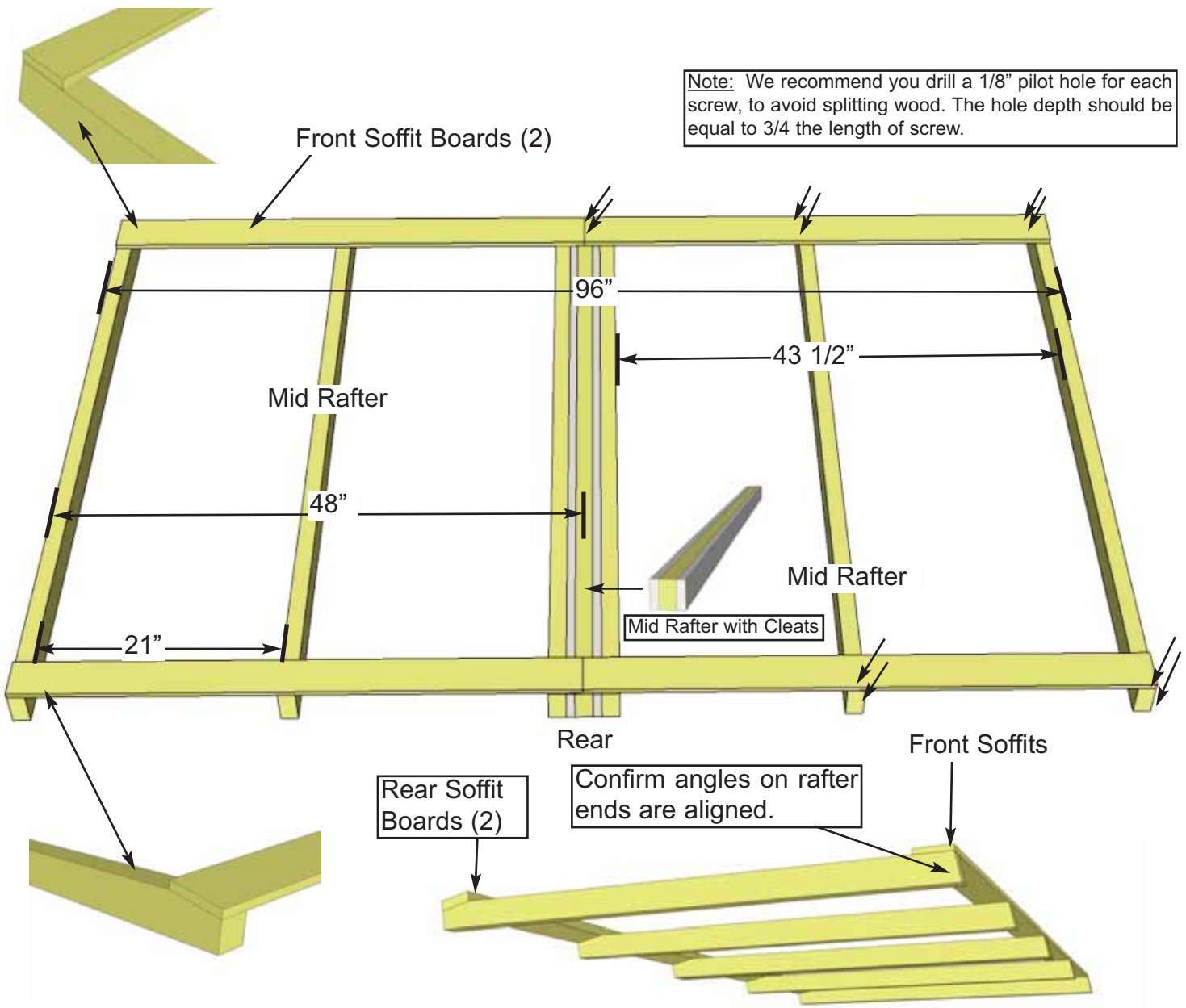

**31.** Locate 7 Rafters, 2 Rear Soffits and 2 Front Soffits. Center Rafter has 3/4" cleats attached on both sides making the width 3". Lay out on level ground and assemble as shown in Illustrations A through C below. Attach Soffit Boards flush to end of outside rafters with 2 - 1 1/4" screws per rafter end. **Important:** Drill pilot holes in Soffit ends to prevent splitting. Measure and attach interior Rafters as illustrated above. Measure and attach remaining Soffit/Rafter connections using 2 - 1 1/4" screws per rafter/soffit.

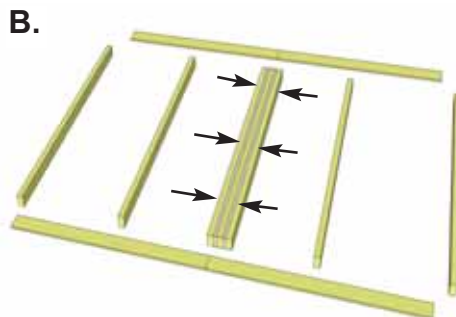

Screw center rafters together with 6 - 2 1/2" screws.



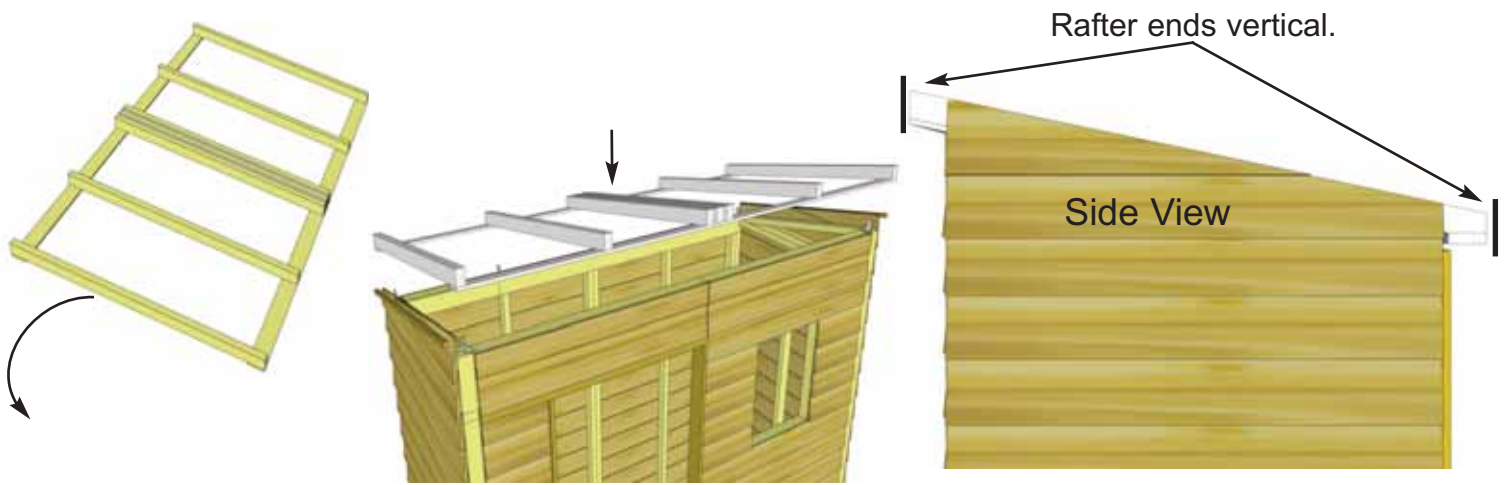

**32.** Carefully flip completed Rafter Section over so Front Soffit is facing the front and place on GardenSaver walls. **Note:** Double check that your Rafter Section is positioned correctly by ensuring the ends of the Rafters are sloped vertically as shown above.

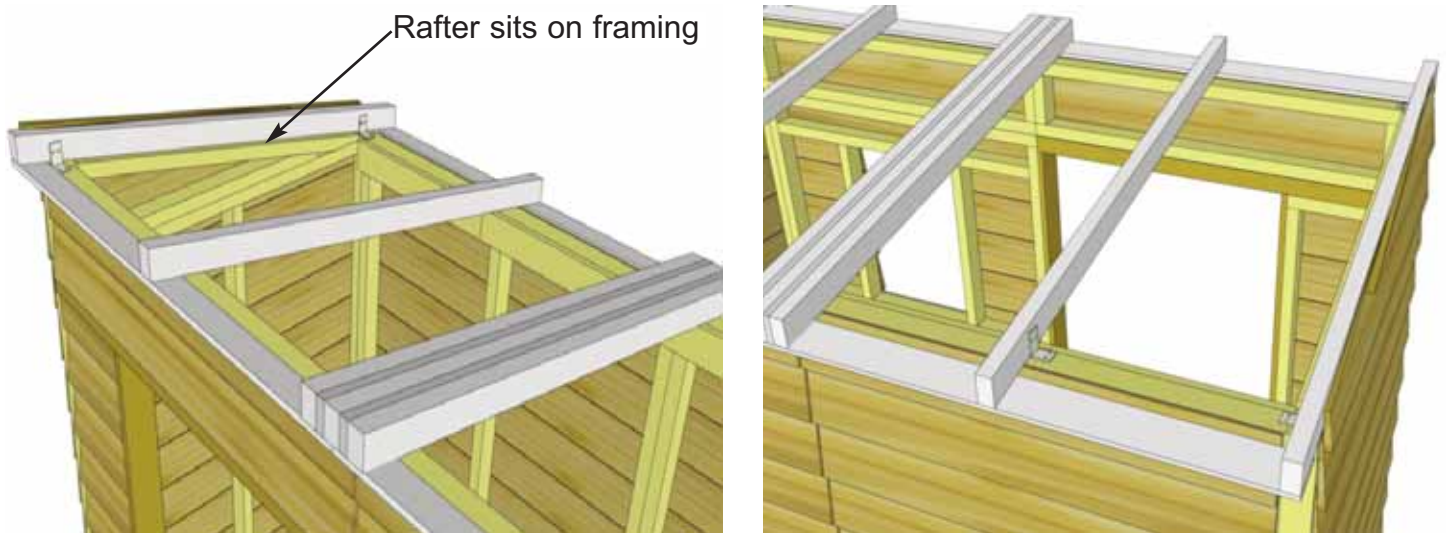

**33.** Position completed Rafter Section on top of walls. Outside **Rafters** will sit on **Extension Wall** framing and be positioned equally from side to side.



**34.** When Rafter Section is positioned correctly, both Front and Rear Soffits will sit approximately 1/8" away from wall siding. This can vary slightly.

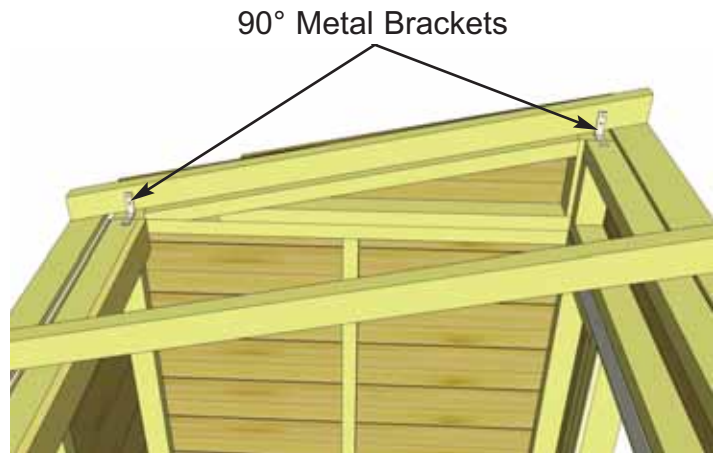

**35.** With Rafter Section correctly aligned, secure rafters to walls using **8 - 90° Metal Brackets**. Start with outside rafters and work inwards, attaching with **16 - 1 1/4" screws**. Screw into **Wall Extension Framing** at the front, and **Wall Panel top Framing** at the rear. Complete both sides.

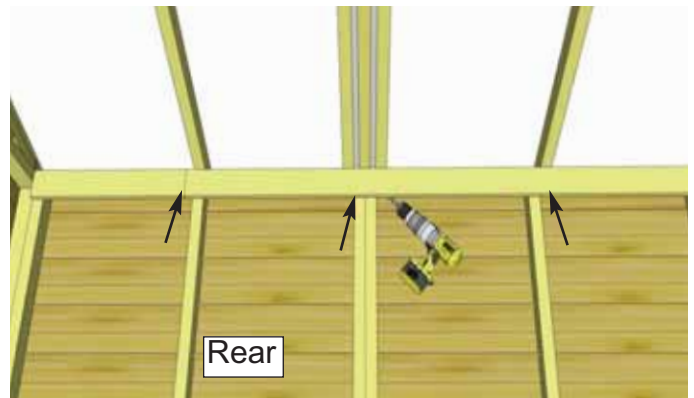
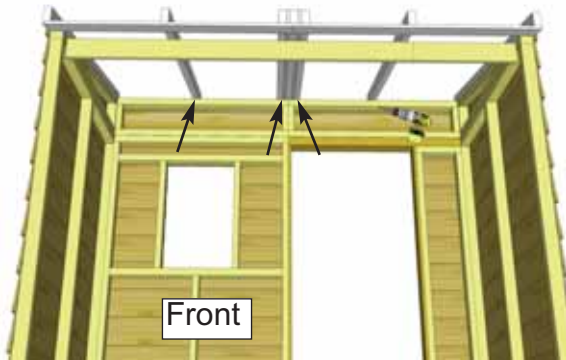

**36.** With outside rafters properly secured, completely secure remaining interior rafters using **8 - 3" Screws**. Screw into rafters from inside of **Extension Wall Framing** at front of shed and inside Rear Wall framing at rear of shed, behind Horizontal Wall Cleats.

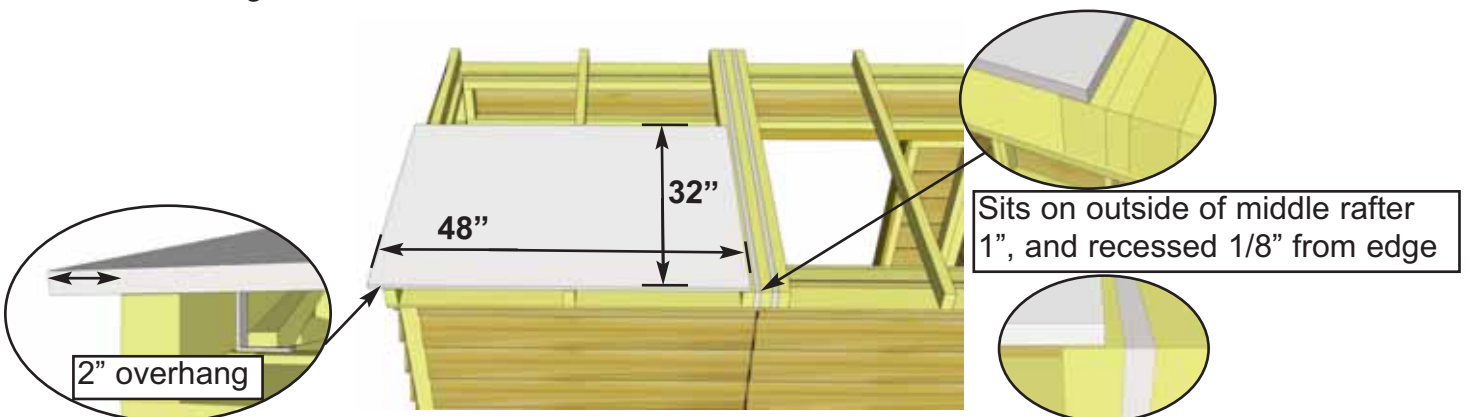

**37.** There are 3 different plywood roof panel sizes required to complete roof.

48" wide x 32" long x 2 pcs. - **Long Plywood Roof Panel**

48" wide x 21 3/4" long x 2 pcs. - **Short Plywood Roof Panel**

4" wide x 53 3/4" long x 1 pc. - **Center Plywood Roof Panel**

Starting with rear left corner, position **Long Plywood Roof Panel 9** (48" wide x 32" long) rafters. Plywood will overhang outside rafter by 2". In the front, plywood will be recessed 1/8" back from rafter end.

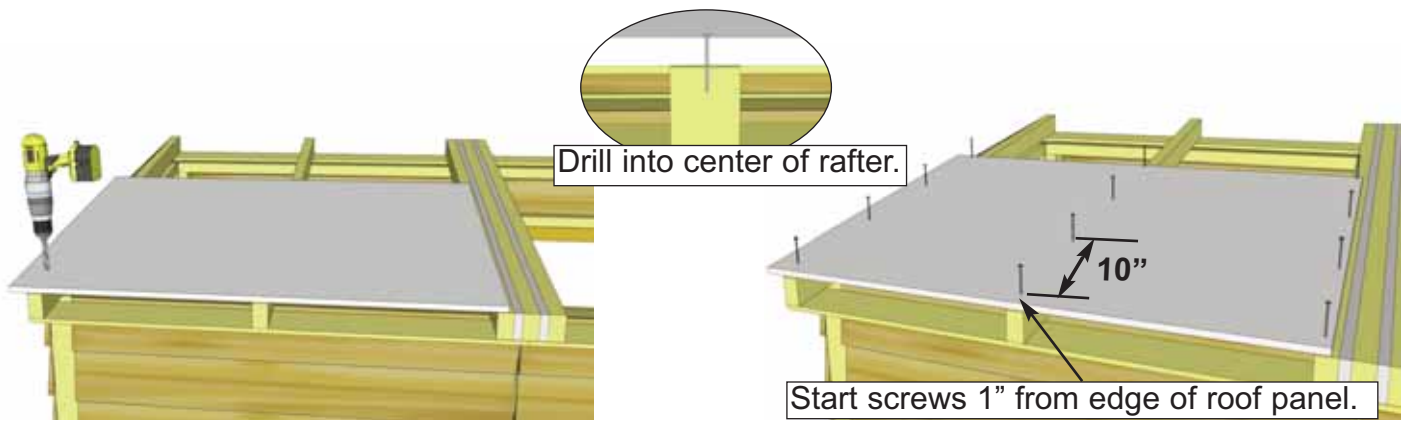

**Important:** Pre-drill pilot holes through roof panel and rafters with 1/8" bit to prevent splitting.

**38.** With panels positioned correctly, attach to rafters with **12 - 1 1/4" screws**. Before attaching screws pre-drill pilot hole with 1/8" bit to prevent rafters from splitting. Start screws 1" away from edge of roof panel, then space screws approximately 10" apart. Be sure to attach screws into center of rafters as shown above.

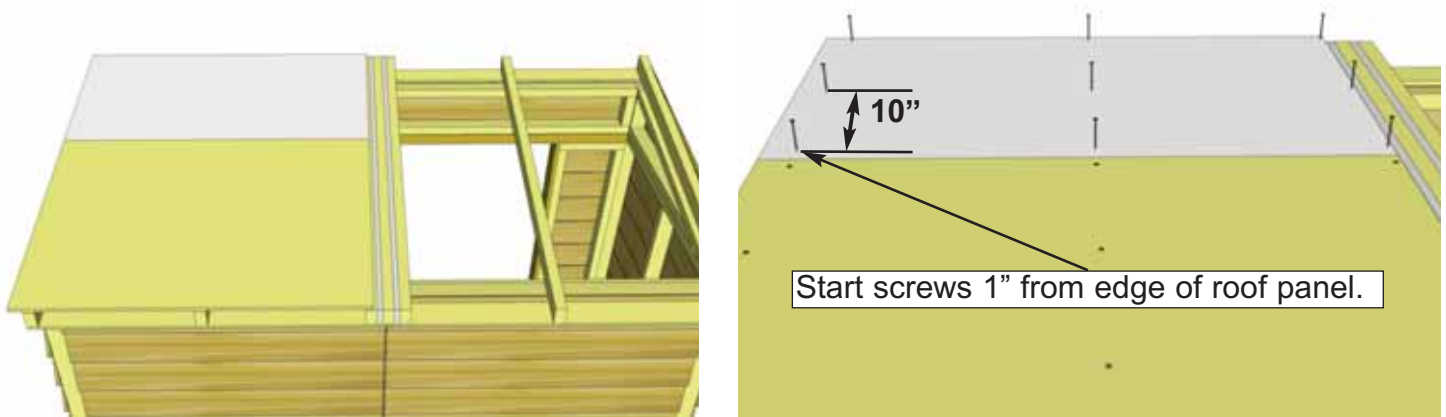

**39.** Locate **Short Plywood Roof Panel** (48" wide x 21 3/4" long) and position on rafters tight against large roof panel. Position with same side overhang. Once positioned attach with **9 - 1 1/4" screws**. Pre-drill pilot holes and drill into center of rafter. Start screws 1" from edge of roof panel and space approximately 10" apart.

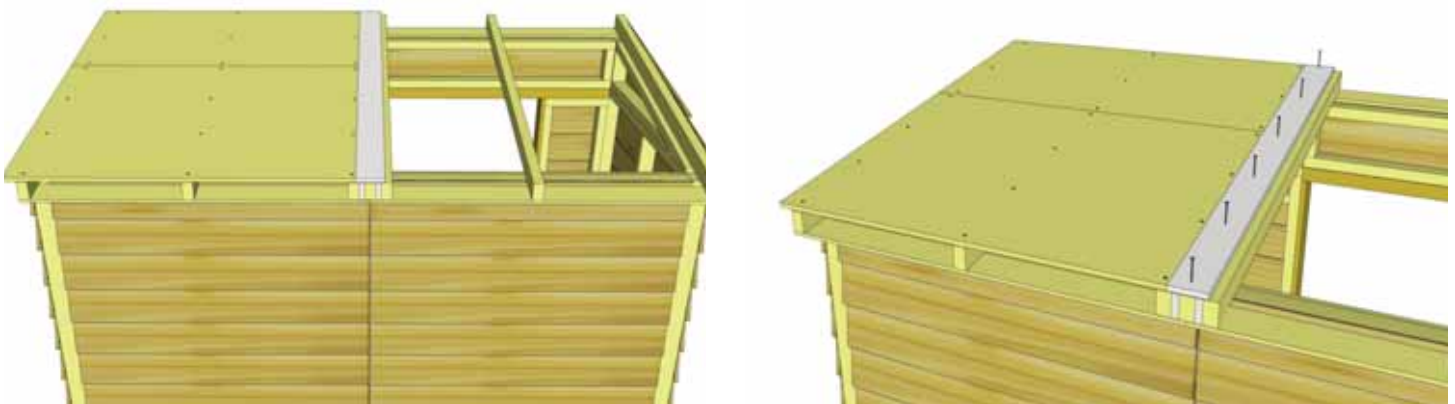

**40.** Locate **Center Plywood Roof Panel**. Place Center Roof Panel on rafters tight to previous two panels. Secure center roof panel with **6 - 1 1/4" screws** into center rafter as per **Steps 38-39**.

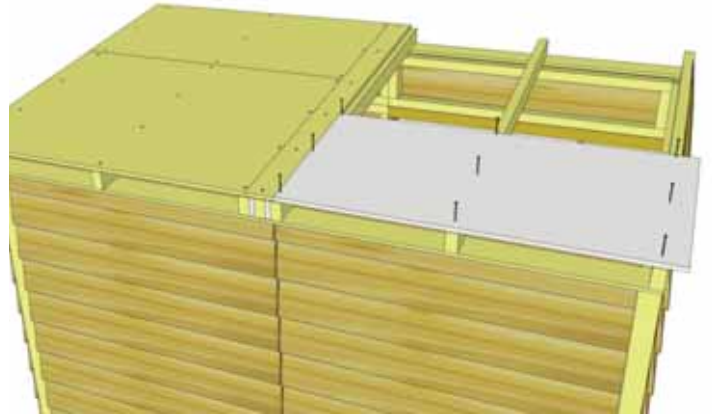
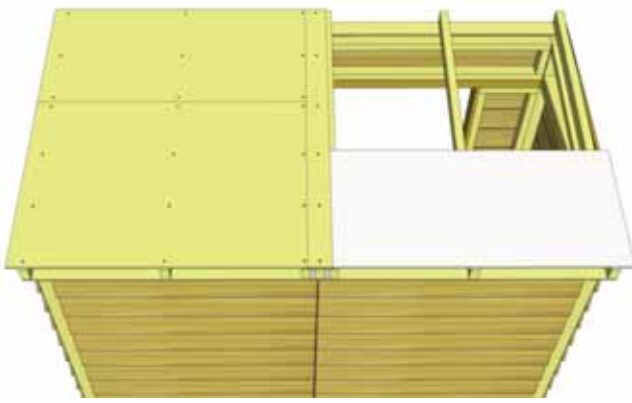

**41.** Locate second **Small Plywood Roof Panel**. Position on rafters on rear of shed. Attach to rafters with **9 - 1 1/4" screws** as per **Step 39**.

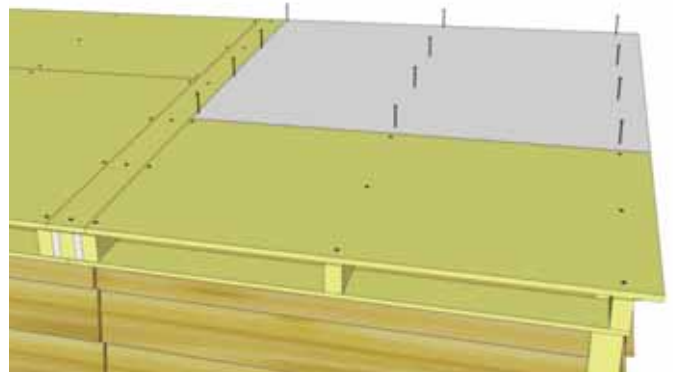
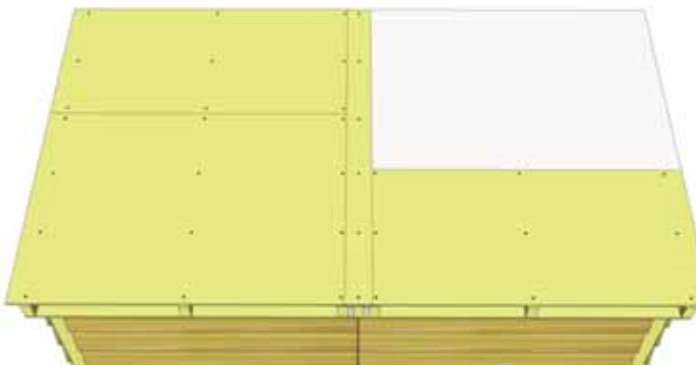

**42.** Locate second **Large Plywood Roof Panel**. Position on rafters on rear of shed. Attach to rafters with **12 - 1 1/4" screws** as per **Step 38**.

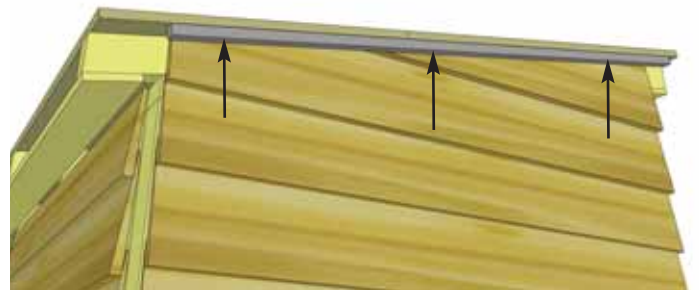

**43.** Center **Rafter/Facia Nailing Plates** (2) (3/4" x 3/4" x 51") onto outside of each plywood panel flush on edge. Attach with **4 - 1 1/4" screws** evenly spaced. The Rafter/Facia Nailing Plate provides for a greater nailing surface later when you attach side facia.

# D. Miscellaneous Section

Exploded view of all parts necessary to complete the Skirting, Trim, Facia and Miscellaneous Pieces. Identify all parts prior to starting.

(Not Shown: Door Stops)

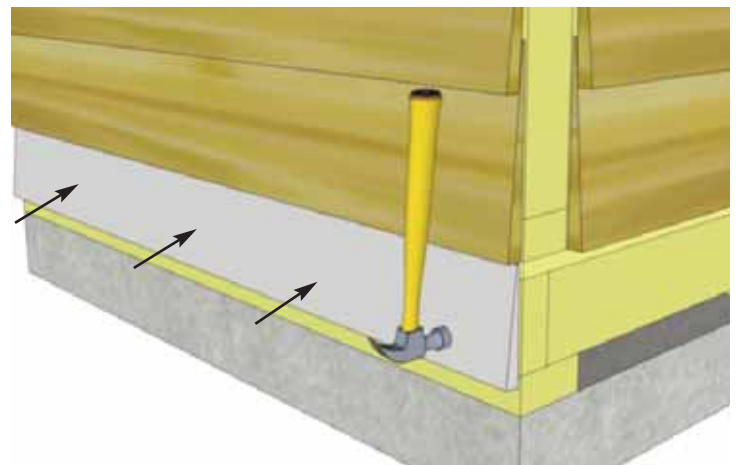
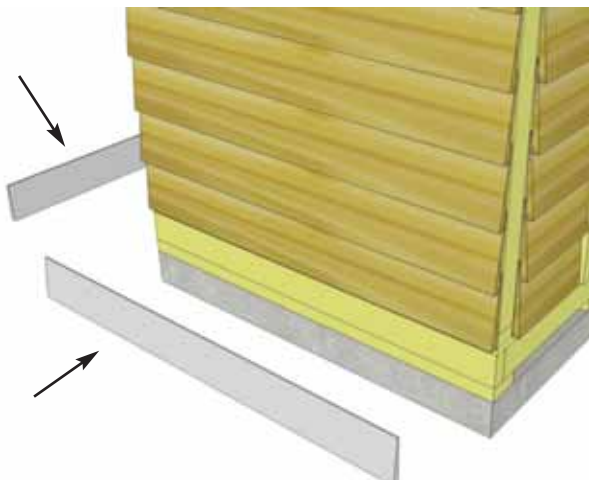
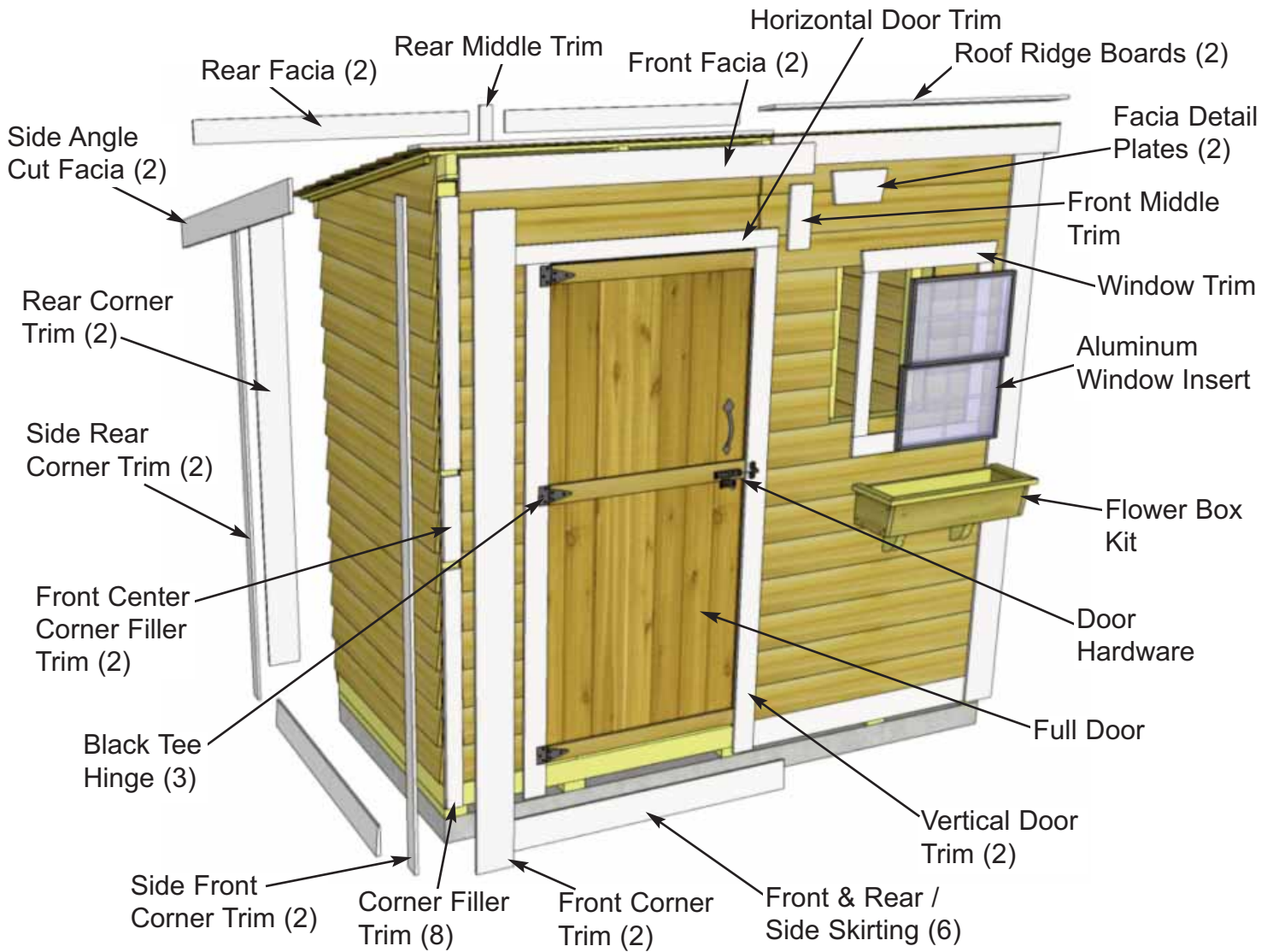

**44.** Attach **Bottom Skirting** (1/2" x 4 1/2" x 45 1/4" - bevel) around the base of the shed. Skirting will hide floor framing. Start with side skirting pieces first and attach with **4 - 1 1/2" Finishing Nails** per piece.

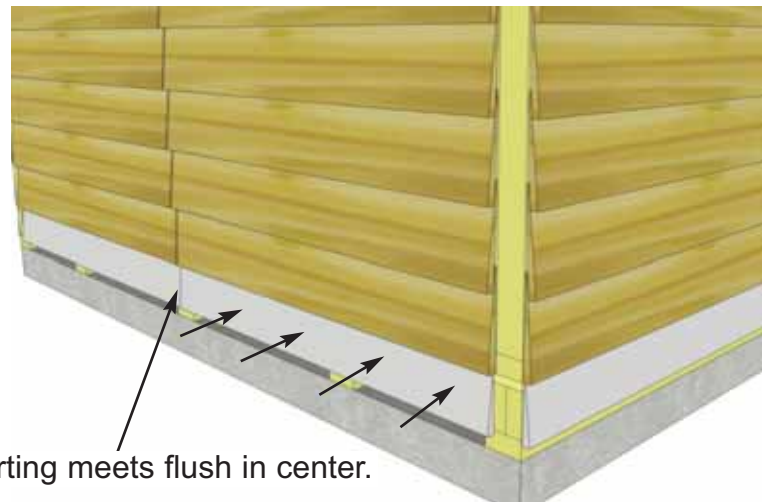

Skirting meets flush in center.

**45.** Rear skirting pieces will meet together in the center. Secure with **4 - 1 1/2" Finishing Nails** per piece.

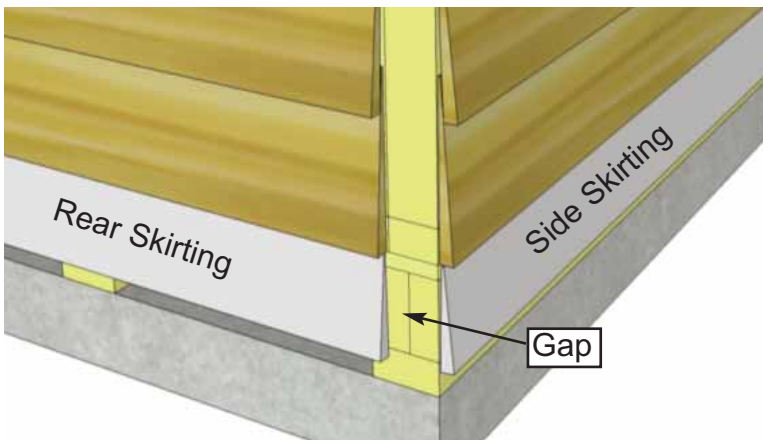

**46.** Gaps on outside will be covered by Corner Trim pieces later. Complete front and side skirting attachments.

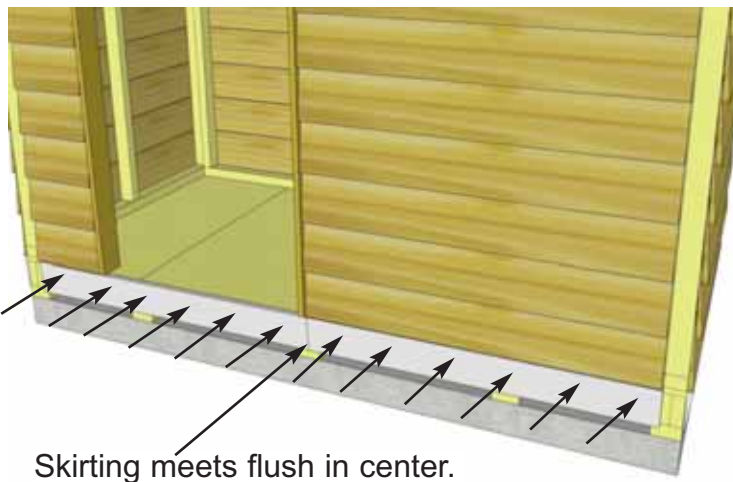

Skirting meets flush in center.

**47.** Use **6 - 1 1/2" Finishing Nails** on front skirting piece where doors will be installed. This adds extra support to a high traffic area.

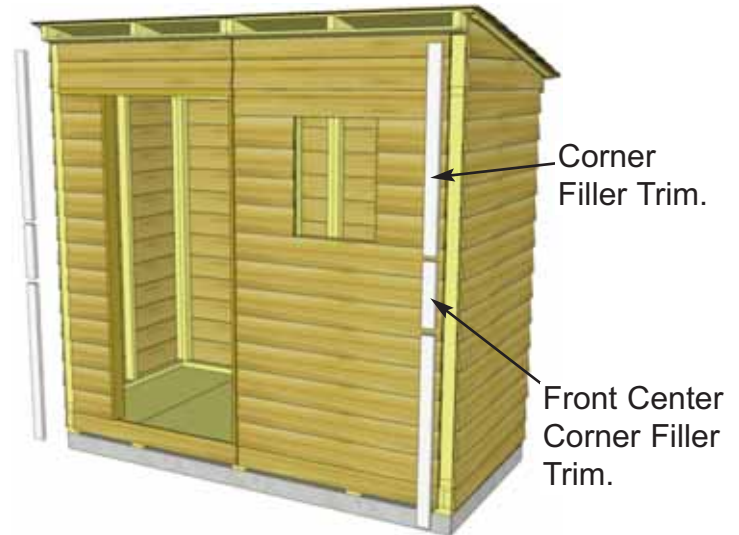

**48.** Locate **Corner Filler Trims** (8 - 3/4" x 2 1/2" x 36") and **Front Center Corner Filler Trims** (2 - 3/4" x 2 1/2" x 10"). Fillers are essentially nailing strips and will not be visible once additional corner trims are attached later.



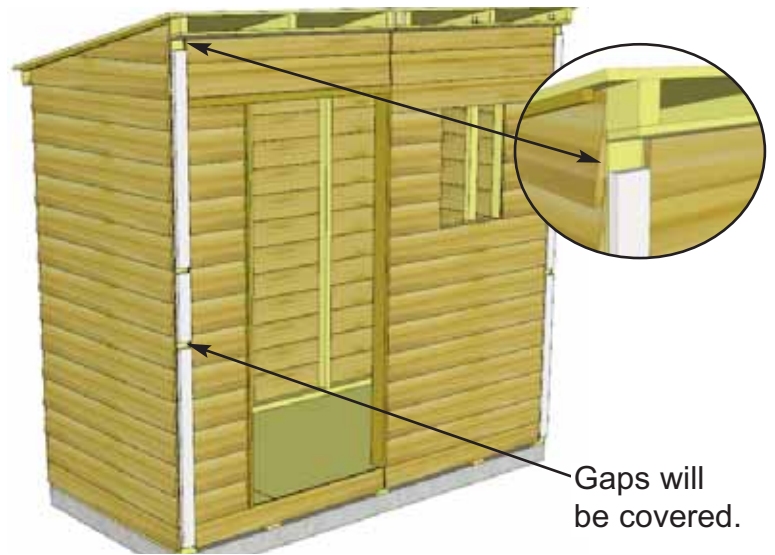
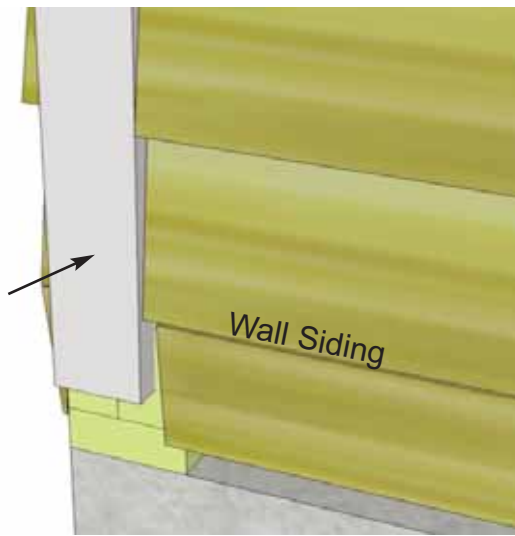

**49.** Attach **Corner Filler Trims** where gaps exist in front corners (2 per side). Hammer with **8 - 1 1/2" Finishing Nails**. There is an additional 10" long **Front Center Corner Filler Trim** that you will need to center and attach as well using **2 - 1 1/2" Finishing Nails**.



Gaps will be covered.

**50.** Position and attach Corner Filler Trims in the rear as per **Step 48**.

**51.** To completely trim out front corners, locate a **Side Front Corner Trim** (1/2" x 2 1/2" x 88 3/4") and a **Front Corner Trim** (1/2" x 5 1/2" x 88 3/4").

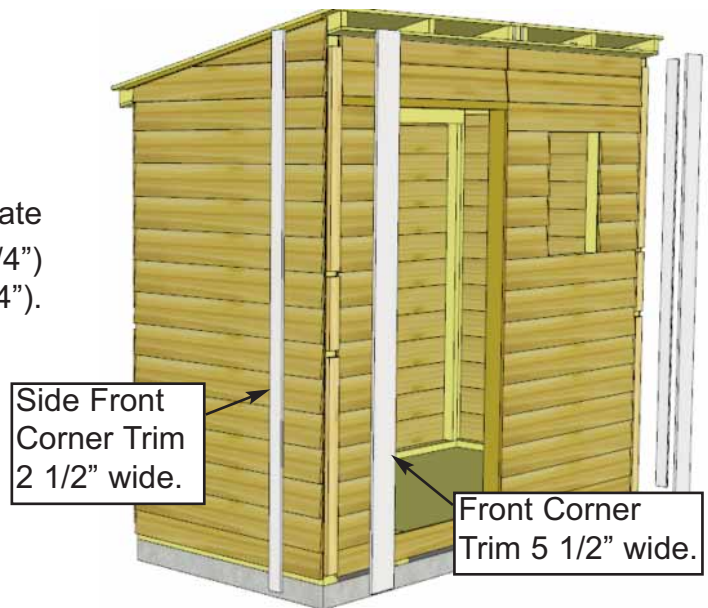

**52.** Place both trims in front corner and align as illustrated. Do a dry run prior to attaching to achieve best fit. Start with 5 1/2" wide Front Corner Trim and align tight underneath soffit to determine vertical height. Attach with **8 - 1 1/2" Finishing Nails** per piece. Position and attach Side Front Corner Trim (2 1/2" wide) using **8 - 1 1/2" Finishing Nails**, aligning at bottom with wide trim.

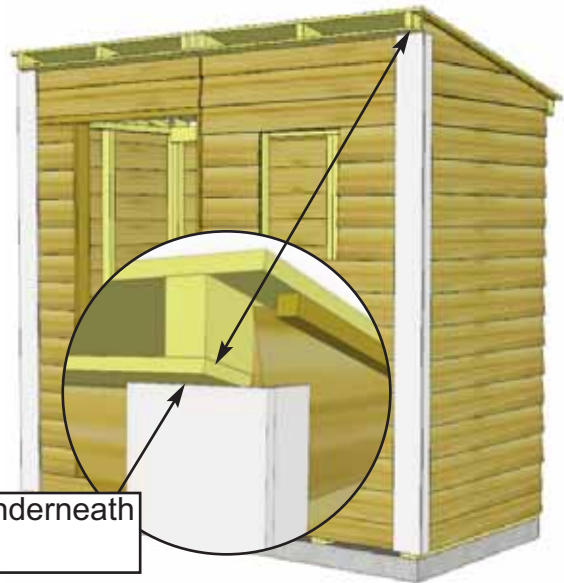

Tight underneath soffit.

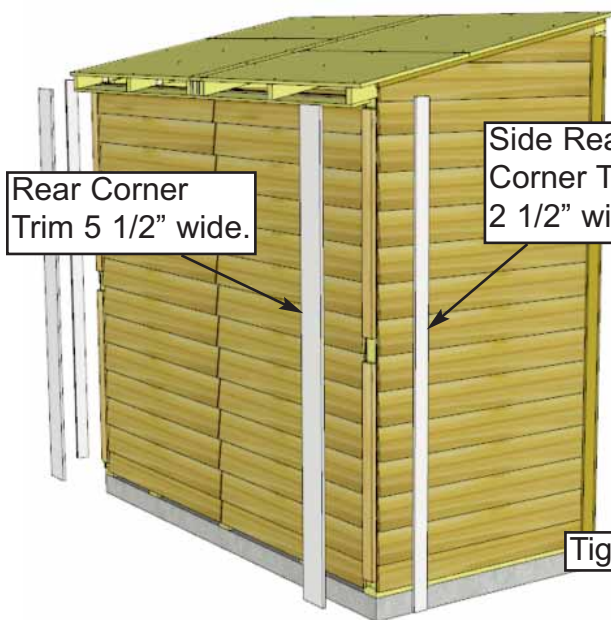

Rear Corner Trim 5 1/2" wide.

Side Rear Corner Trim 2 1/2" wide.

Tight underneath soffit.

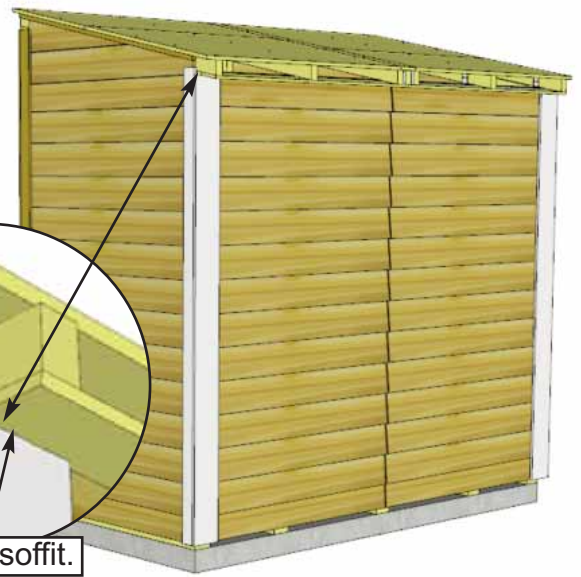

**53.** To completely trim out rear corners, locate **Side Rear Corner Trims** (1/2" x 2 1/2" x 80") and **Rear Corner Trims** (1/2" x 5 1/2" x 79"). Align and attach as per **Step 52**.

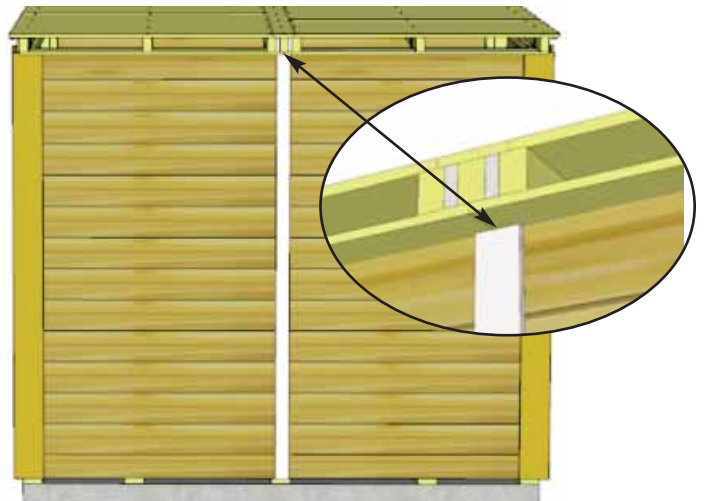

**54.** Attach **Rear Middle Trim** (1/2" x 2 1/2" x 79") where wall panels come together at rear seam. Attach with **8 - 1 1/2" Finishing Nails** aligning tight underneath soffit and center on seam.

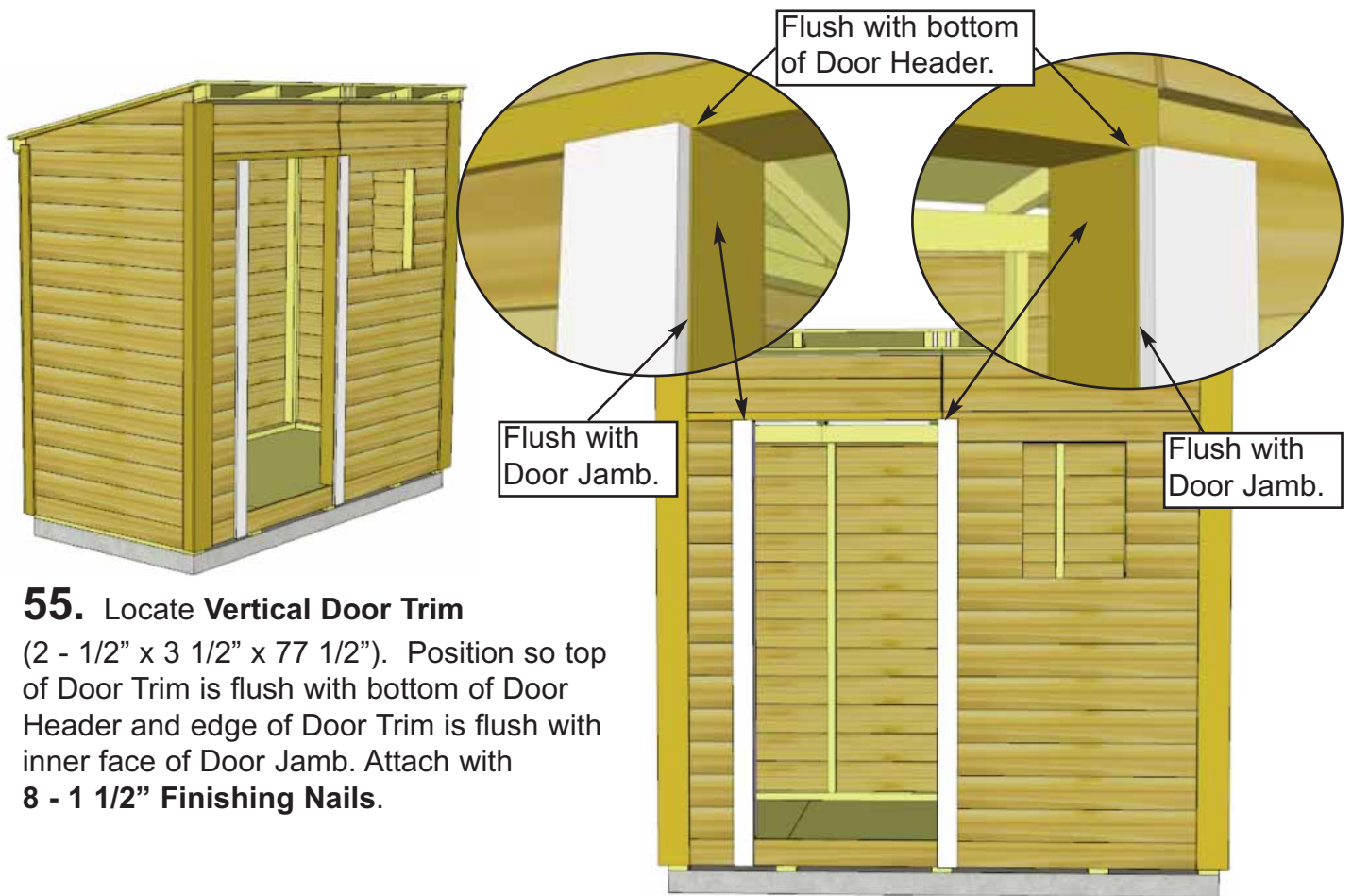

**55.** Locate **Vertical Door Trim** (2 - 1/2" x 3 1/2" x 77 1/2"). Position so top of Door Trim is flush with bottom of Door Header and edge of Door Trim is flush with inner face of Door Jamb. Attach with **8 - 1 1/2" Finishing Nails.**

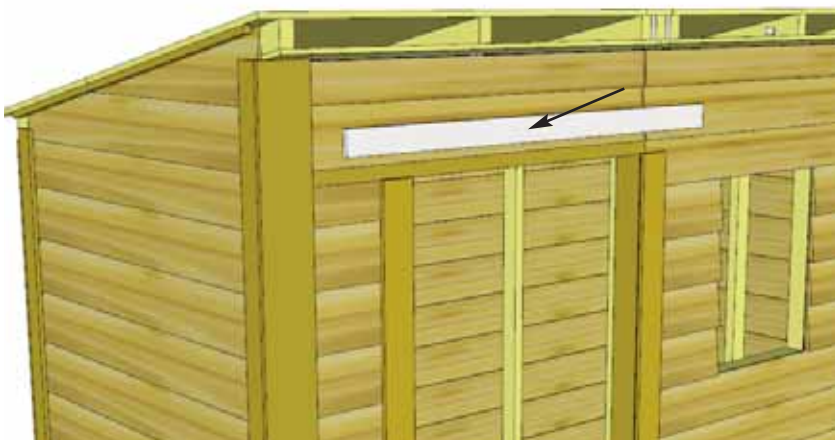

**56.** Locate **Horizontal Door Trim** (1 - 1/2" x 2 1/2" x 46 3/4"). Position piece as shown and attach with **4 - 1 1/2" Finishing Nails.**



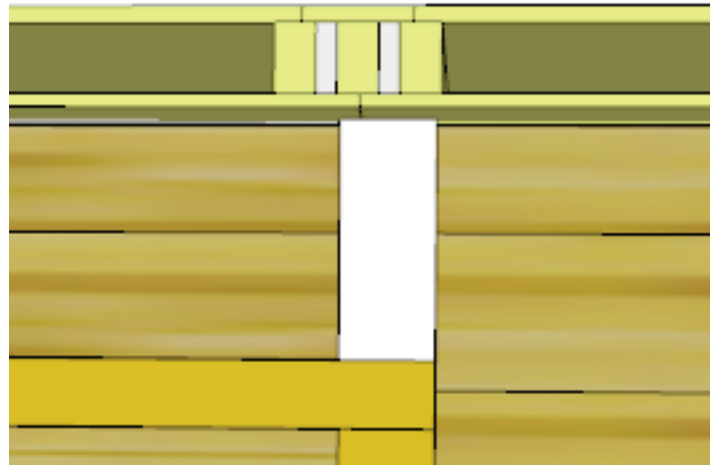
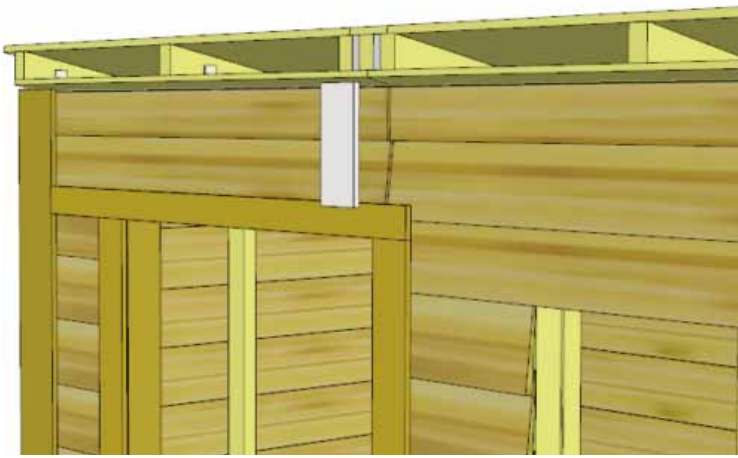

**57.** Locate **Front Middle Trim** (1 - 1/2" x 3 1/2" x 8 3/4"). Position tight against Horizontal Door Trim and in line with Vertical Door Trim. Attach with **2 - 1 1/2" Finishing Nails**.

**Important - Drill Pilot Holes to prevent splitting.**

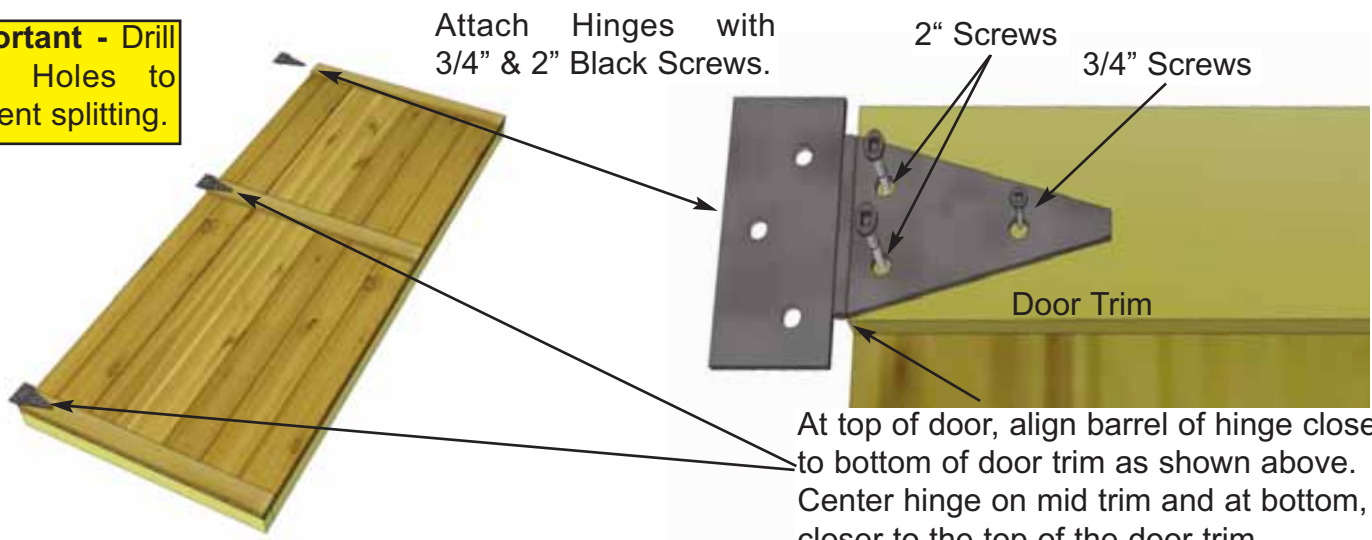

**58.** Attach Door Hinges to **Solid Door**. Position Hinges equally on door trim as shown above and attach with **Black 3/4"** and **2" Screws**.

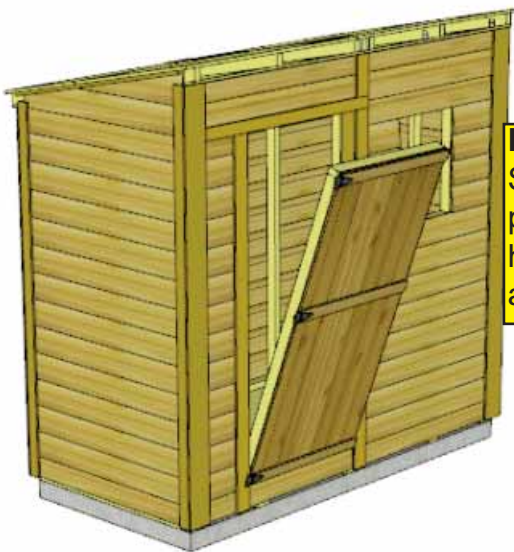

**Hint:** Use Shim Shingle or extra piece of siding to help space Door at top and bottom.



**59.** With Hinges attached, position door in opening. You will need some assistance to hold door in place.

**Important - Drill Pilot holes to prevent splitting.**

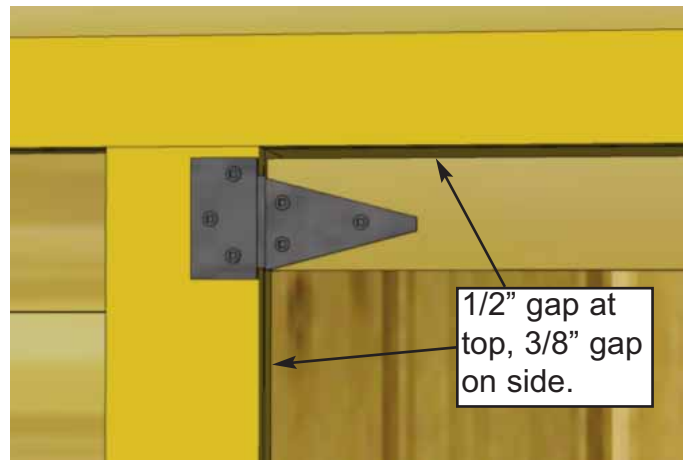
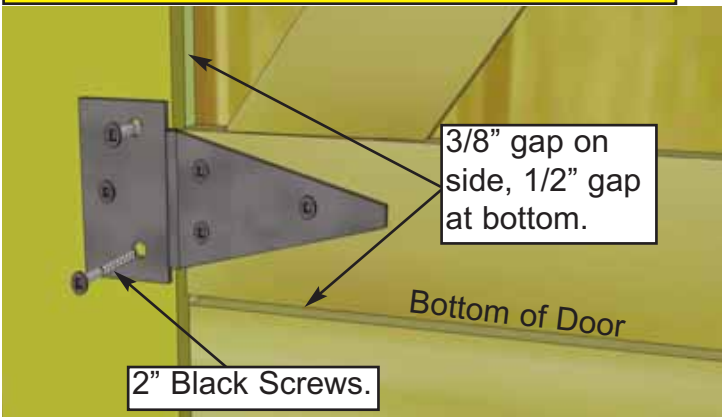

**60.** Once door is align in opening, position so there is a 1/2" gap on bottom, and approximately 3/8" on the side. Use a spare piece of siding or shingle to shim door in place at the bottom. Using **2" Black Screws**, secure bottom hinge to Door Trim. **Hint:** Do not attach all the 2" screws until the door is positioned correctly. You can use a Screw Driver to tighten screws completely so you don't over tighten.

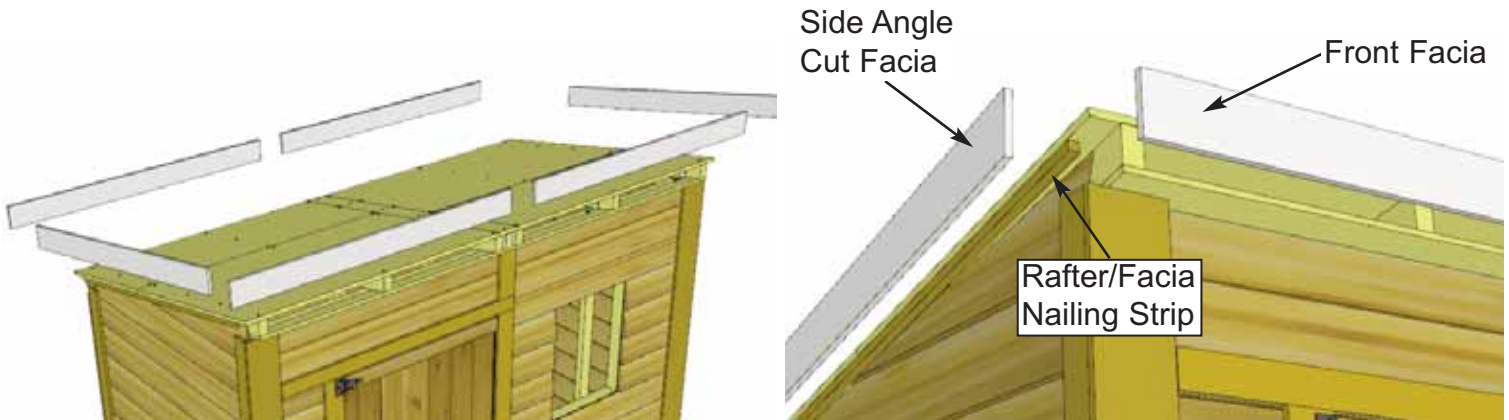

**61.** Locate and identify all Fascia pieces: **Front & Rear Fascia (4)** (1/2" x 4" x 50 1/2"). **Side Angle Cut Fascia (2)** (1/2" x 4" x 54 1/8"). In front corner, align side and front Fascia together. Front fascia will cap side fascia.

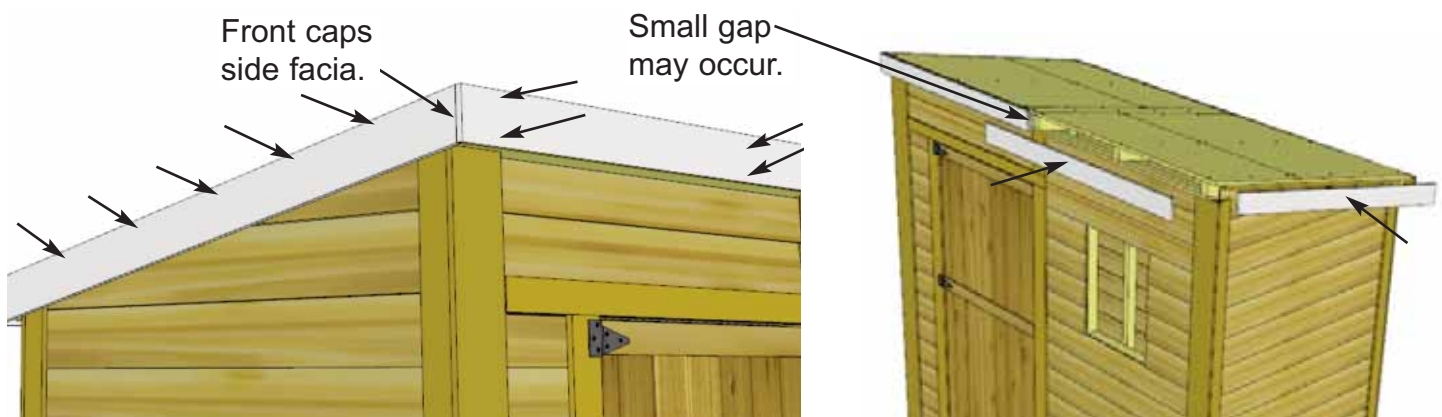

**62.** Do a dry run first before securing. Position Front Fascia up underneath roof panel and against rafter ends. Have your helper hold in position. Place angle cut Side Fascia underneath roof panel against Rafter/Fascia Nailing Strip. Align so Front Fascia caps Side Fascia and then attach the front with **6 - 1 1/2" Finishing Nails**. Attach side with **5 - 1 1/2" Finishing Nails** securing them into the nailing plate (closer to the top of the side fascia board). Attach next piece of Front Fascia. **Note:** With Front Fascia correctly aligned at corners, a small gap may occur at center seam. This will be covered by Fascia Detail Plate in **Step 64.**

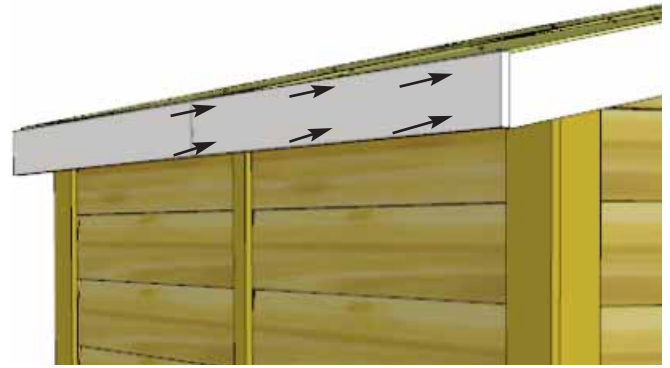
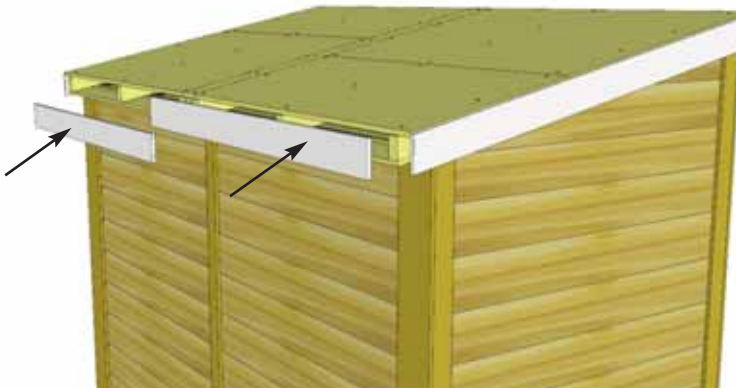

**63.** Place and align rear and side fascia for best possible fit with rear capping side fascia. Attach fascia to rafter ends with **6 - 1 1/2" Finishing Nails** per piece. Complete both rear fascia pieces.

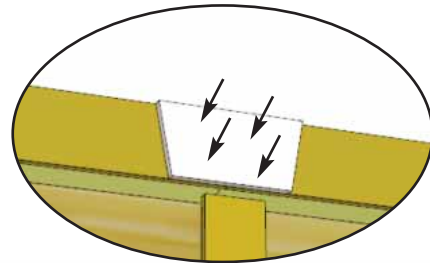
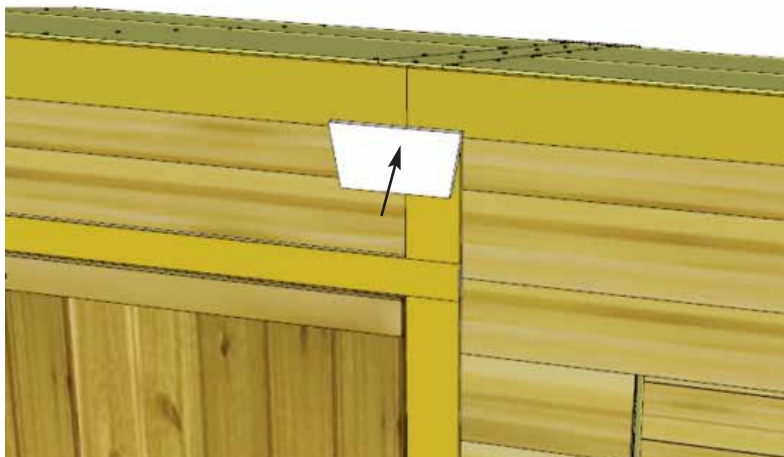

**64.** Attach **Facia / Detail Plates** to cover seams where Front and Rear Facia pieces come together. Secure with **4 - 1 1/2" Finishing Nails** per piece.

**65.** Attach **Upper Interior Door Stop** (1/2" x 1/2" x 32") positioning trim against door jamb and underneath door header flush to edges on inside as shown above. Attach with **4 - 1 1/2" Finishing Nails**.



**66.** Attach upper and lower **Vertical Interior Door Stops** as per **Step 65**. Position against door jamb and underneath upper door trim. Attach with **4 - 1 1/2" Finishing Nails** per piece. Complete both sides.

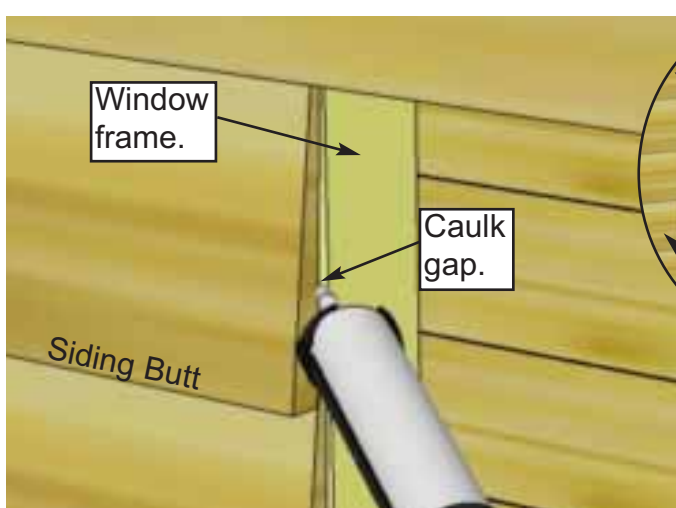
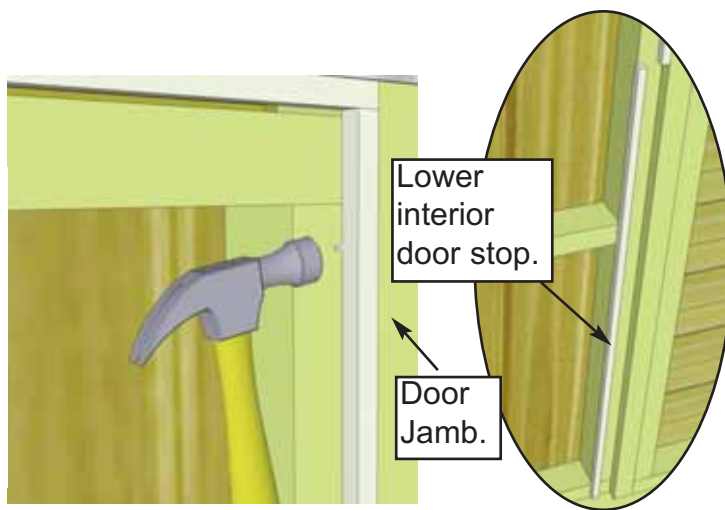

Screw insert into bottom (thick) part of siding.



**67.** To reduce possible water from penetrating into the window cavity, caulk gap on both sides of window opening prior to installing **Window Insert**. Position insert in cavity and screw with **6 - 8 1 1/4" Screws**. On sides, make sure to screw insert into the thick butt of the siding only.

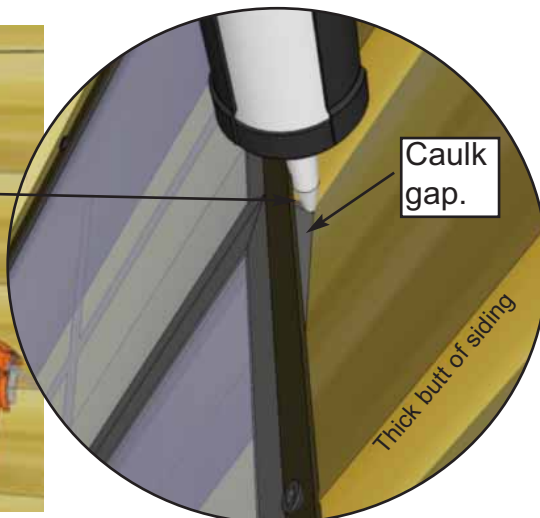
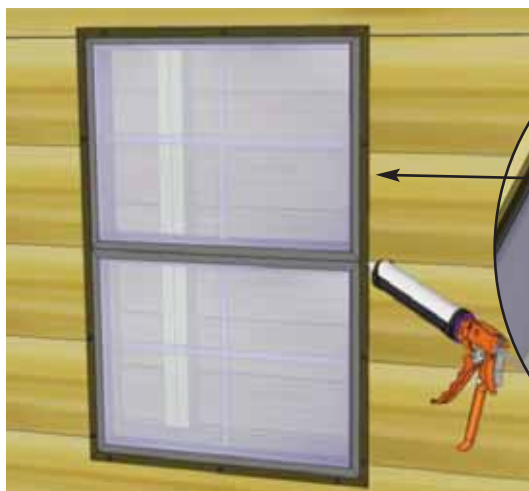

**68.** Once Insert is attached, caulk the "triangular gap" between the Insert's outside flange and the siding. Also put a bead of caulking horizontally at top of window where the flange and siding meet. This additional caulking will also reduce the chances of moisture entering into your shed.

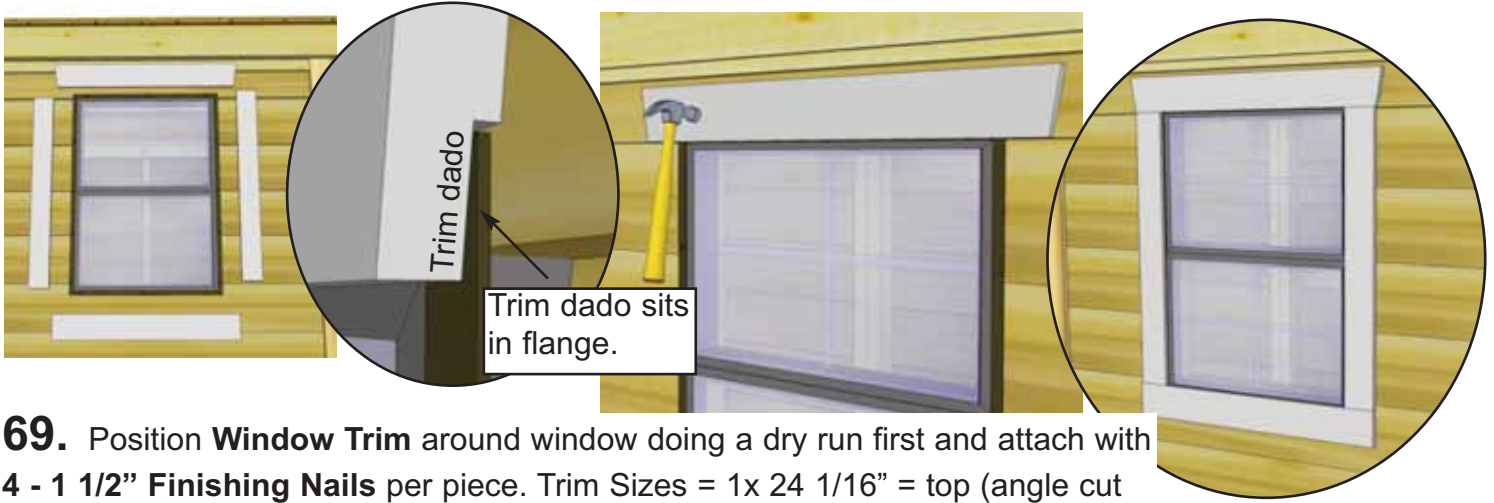

**69.** Position **Window Trim** around window doing a dry run first and attach with **4 - 1 1/2" Finishing Nails** per piece. Trim Sizes = 1 x 24 1/16" = top (angle cut on ends) / 3 x 23" = Sides & Bottom. Window trim has a small dado on reverse face. Outside flange of window will roughly sit in the dado to give a better fit.



**70.** Assemble Flower Box with Assembly Instructions included with this Manual on Page 34. Center completed flower box below bottom of window trim and secure with **2 - 2 1/2" Screws**. Screw from inside of box into the center wall stud. Attach second screw 2" below first screw.



**71.** Attach **Door Handle**. Handle should be positioned with larger flange to top. Mount with **3/4" Black Headed Screws**.

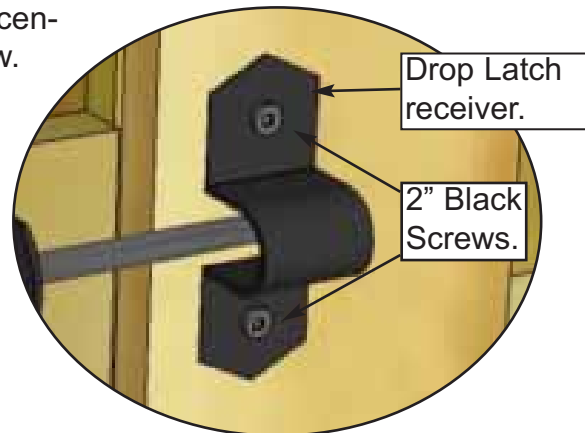
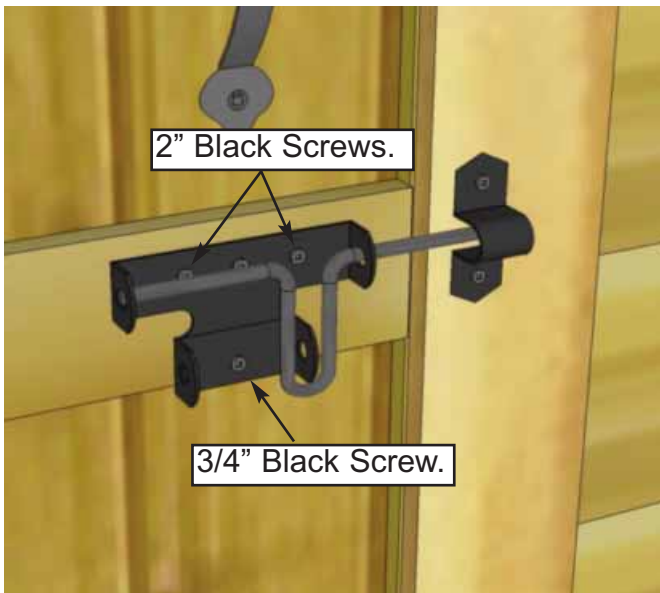

**72.** Attach Black Drop Latch as illustrated above with **2" & 3/4" Black Screws**. Note how Drop Latch receiver is positioned higher than male. Do a dry run first to position Drop Latch correctly.

**Important** - Drill pilot holes with 1/8" drill bit prior to securing with screws to prevent wood splitting. Drill shallow pilot hole only since the screw is only 3/4" long.



**Optional - Door Configuration on End Instructions. (New Door Jamb and Door Trim.)**



**73.** Install Narrow Wall as per **Step 17.**

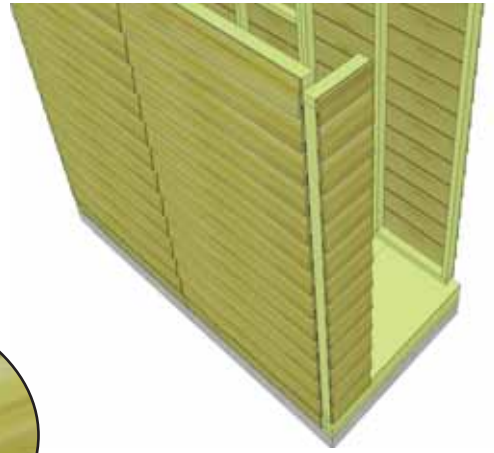

1 1/2" x 3 3/8" x 73"  
Optional Door Jamb.

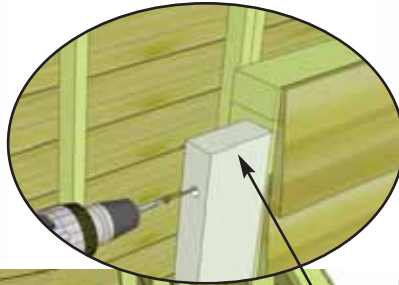

**75.** Attach Door Header as per **Step 21.**

**74.** Position Optional Door Jamb as shown to the right and attach using **4 - 4" Screws** in the pre-drilled holes. Line up Jamb with outside of Side Wall Framing. Use Door Header (45 1/2" long) to align Jamb. Jamb will overhang floor at bottom.

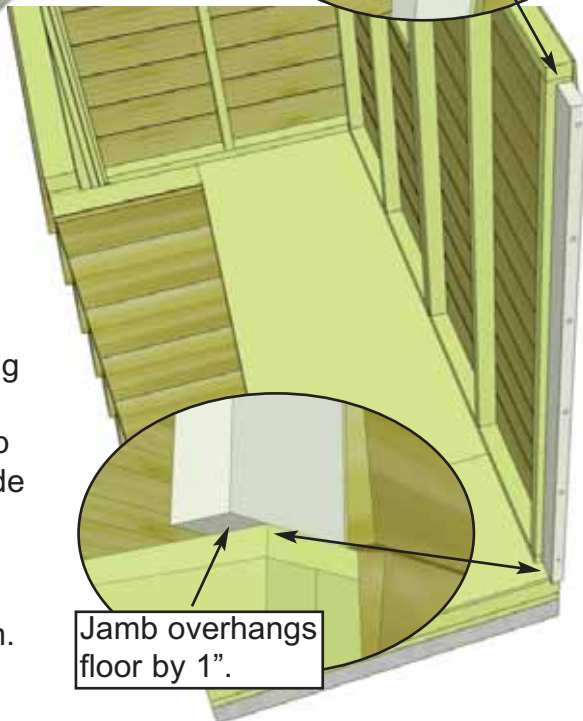

Jamb overhangs floor by 1".

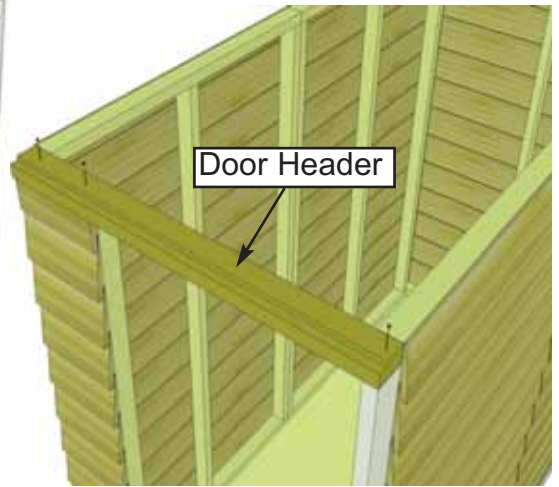

Door Header

1/2" x 2 1/2" x 42 1/2"  
Optional Hor. Door Trim.

Reg. Filler Trim.

1/2" x 2 1/2" x 88 3/4"  
Optional Front Middle Trim.

Reg. Door Trim.

Reg. Corner Trim.

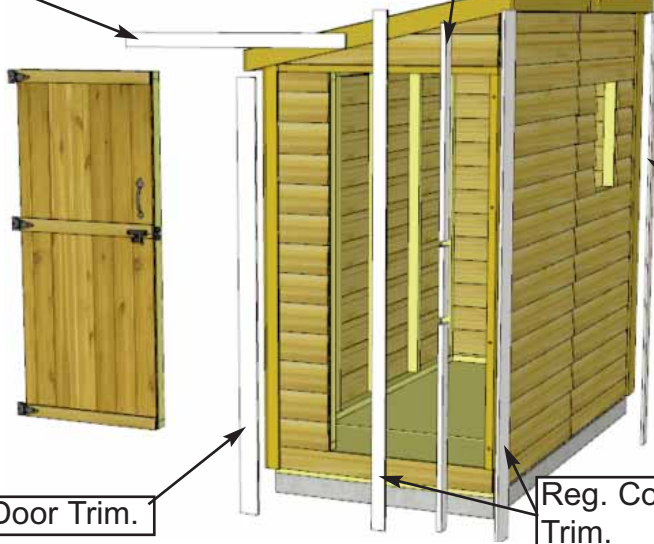

**80.** Install Reg. Door Trim and Hang Door as per **Step 58 - 60.** Attach optional trim as shown. Trim corner as per regular steps.

# Outdoor Living Today Flower Box Assembly Instructions

## Parts Lists:

<b>A - Base, Rear &amp; Front Box Frames</b>	<b>(3pcs)</b>	3/4" x 5 1/2" x 23"
<b>B - End Cap Frames</b>	<b>(2pcs)</b>	3/4" x 5 1/2" x 7" / 8"
<b>C - Front Trim</b>	<b>(1 pc)</b>	3/4" x 1 1/2" x 26"
<b>D - Side Trims</b>	<b>(2 pc)</b>	3/4" x 1 1/2" x 8 3/4"
<b>E - Brackets</b>	<b>(2 pc)</b>	1 1/2" x 5 1/2" x 5 1/2"
<b>F - 1 1/4" Screws</b>		
<b>G - 1 1/4" Nails</b>		

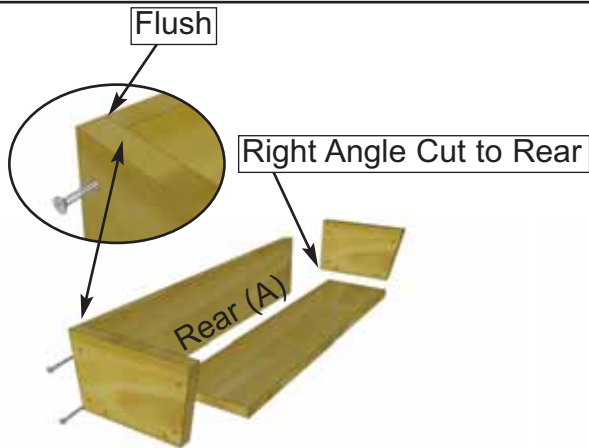
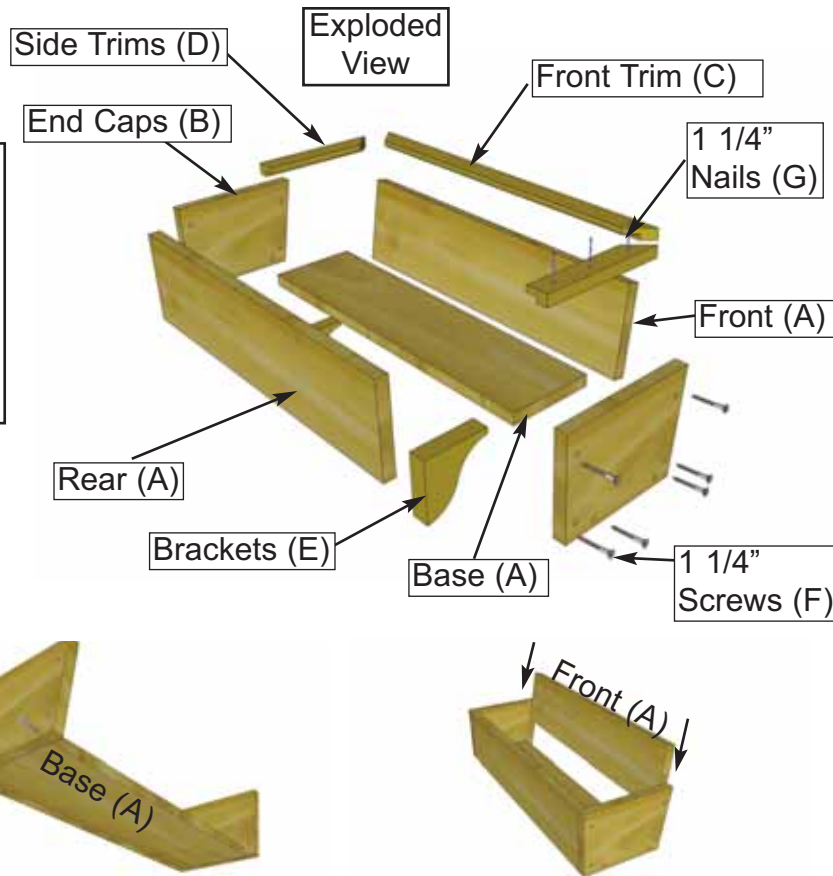

**1.** On a table position Rear Box and End Cap Frames together so flush at top. Fasten together with 2 - 1 1/4" screws. Place Base Frame tight against Rear and End Cap and flush at bottom. Secure with 2 - 1 1/4" screws. Complete attachment of remaining End Cap Frame. Slide Front Frame between End Caps.

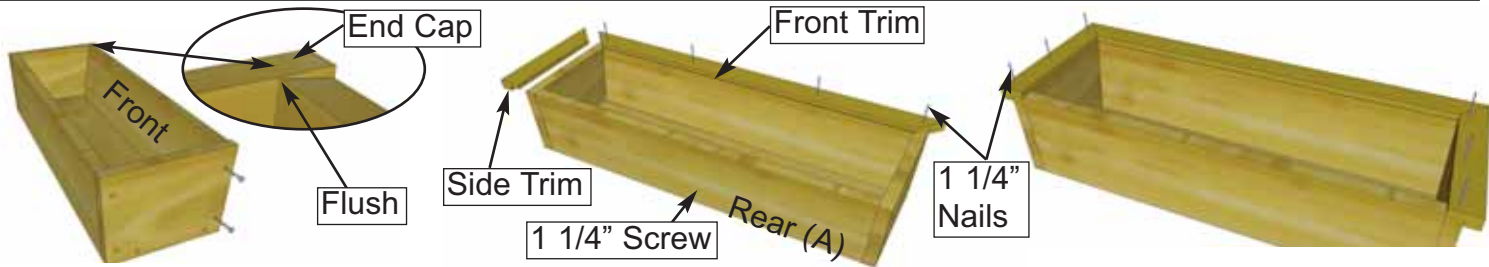

**2.** Position Front Frame Piece flush with End Cap. Attach both ends with 2 - 1 1/4" screws. Pilot hole Rear Box Frame near bottom center and secure to Base edge with 1 - 1 1/4" screw. Evenly position Front Trim (mitre cut on end and dado cut on inside bottom) tight against front frame and nail down with 4 - 1 1/4" nails. Position Side Trims as per Front and secure with 3 - 1 1/4" nails per side.

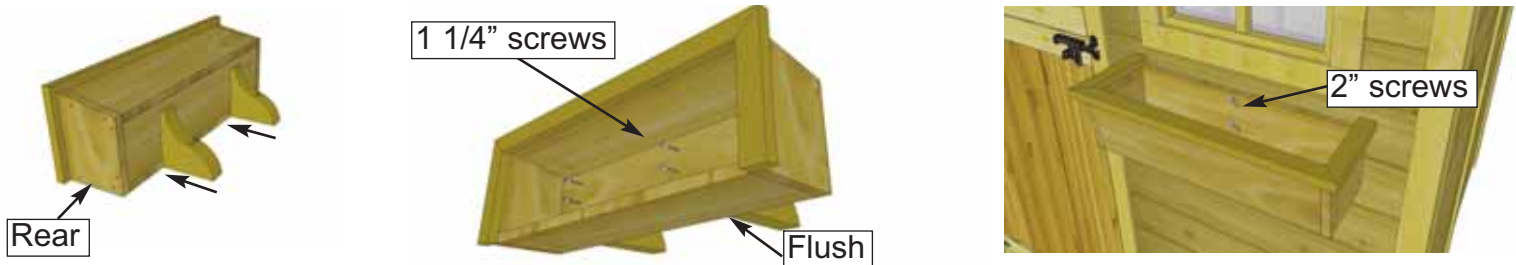

**3.** On a flat surface, flip Flower Box on it's rear face. Evenly space Brackets and secure through Base Frame and into the Brackets with 2 - 1 1/4" screws per Bracket. Position completed Flower Box beneath window trim and screw from inside of box into the center wall stud with 2 - 2" screws. (2" screws supplied with Base Kit.)



## Congratulations on completing your 8x4 GardenSaver Garden Shed - Single Door - Finger Jointed!

**Note:** Our Sheds are shipped as unfinished products. If exposed to the elements, the Western Red Cedar lumber will weather to a silvery-gray color. If you prefer to keep the cedar lumber looking closer to the original color, we suggest that you treat the wood with a good wood stain. You may also wish to paint your new shed rather than stain it. In both cases we recommend that you consult with a paint and stain dealer in your area for their recommendations.



We value your feedback and would like to hear back from you on how well we are doing in the following areas:

1. Customer Service
2. On Time Shipping
3. Motor Freight Delivery
4. Quality of Materials
5. Assembly Manual
6. Overall Satisfaction.



Optional door configuration



The materials contained in this Assembly Manual may be downloaded or copied provided that ALL copies retain the copyright and any other proprietary notices contained on the materials. No material may be modified, edited or taken out of context such that its use creates a false or misleading statement or impression as to the positions, statements or actions.

Please call, write or email us at:

Outdoor Living Today

Canadian Address  
9393 287th Street  
Maple Ridge, British Columbia  
Canada V2W 1L1

United States Address  
P.O. Box 96  
Sumas, Washington  
USA 98295

Toll Line: 1.888.658.1658

Fax: 1.604.462.5333

sales@outdoorlivingtoday.com