

Thank you for purchasing a 9x6 Cabana. Please take the time to identify all the parts prior to assembly.



Note: The General Assembly Manual illustrates a Door Configuration in the front center location. The Door can also be positioned in the front corners. To correctly configure Door in front corners, follow general assembly steps and refer to Page 37 for required changes.



Safety Points and Other Considerations

Our products are built for use based on proper installation and normal residential use, on level ground. Please follow the instruction manual when building your shed and retain the manual for future maintenance purposes.

Some of the safety and usage measures you may wish to consider include:

- snow load ratings vary by geographical location. If heavy or wet snowfall occurs, it is advisable to sweep the snow off the roof(s).
- if the product is elevated, any structural and building code requirements are solely the customer's responsibility, and should be abided by.
- in high or gusty wind conditions it is advisable to keep the structure securely grounded.
- have a regular maintenance plan to ensure screws, doors, windows and parts are tight.

Customer agrees to hold Outdoor Living Today Partnership and any Authorized Dealers free of any liability for improper installation, maintenance and repair.

In the event of a missing or broken piece, simply call the Outdoor Living Today Customer Support Line @ 1-888-658-1658 within 30 days of the delivery of your purchase. It is our commitment to you to courier replacement parts, free of charge, within 10 business days of this notification. Replacement parts will not be provided free of charge after the 30 day grace period.

What to do before my Shed arrives?



- Become familiar with this assembly manual and determine if you can complete the project yourself or will require a professional contractor.



- One helper is recommended to assist in constructing your shed. It generally takes two people over two days to assemble a shed. If you're hiring a contractor, their rate should be in line with that duration of work.



- Clear the construction area and ensure a clear pathway for delivery when the freight company arrives. Remove all debris: roots, grass, rocks, etc.



- Excavate the site. Contact your local utilities company to ensure there are no gas or electric lines buried in the area before digging.



- Decide on the type of foundation you will be using:
 - Concrete slab, or
 - 4-6 inches of crushed gravel with paver stones or 4x4 stringers.

You can find the footprint for your shed on Page 3 of your Assembly Manual.



- If doing the assembly yourself, have all the necessary tools ready to go and in working condition. A list of required tools can be found after the parts list.

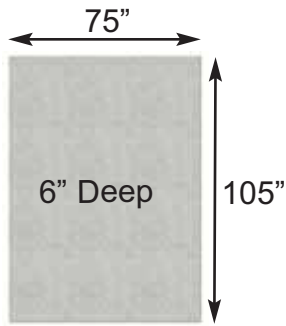

Concrete Foundation

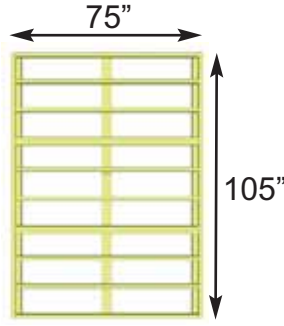

Floor Frame



Completed Foundation

Concrete Slab Foundation:

- Slab must be at least the same size as assembled floor frame (75" x 105") or larger.
- 6" Deep foundation.
- 1.0 Cubic Yards of concrete required.
- A concrete slab will have the longest durability out of your foundation options.

Once level, a concrete slab is the easiest surface to build on.

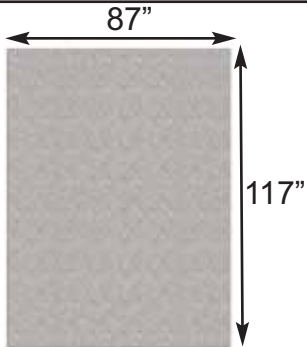

Gravel Foundation

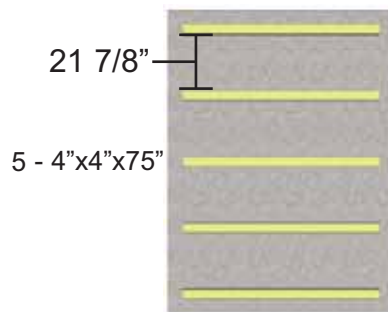

Gravel Foundation with treated stringers



Completed Foundation

Gravel with 4x4 Pressure Treated Stringers:

- Excavate at least 6" deep, and 6" wider than floor frame on each side.
- 1.4 Cubic Yards of gravel required, approximately 13 wheelbarrows.
- 5 - 4x4 Pressure Treated Stringers 75" long required.
- Evenly spaced, with one at each end of floor frame.

Saves money on materials, easy to level and work with.

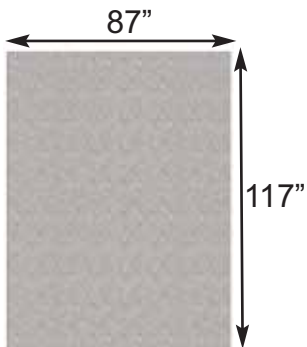

Gravel Foundation

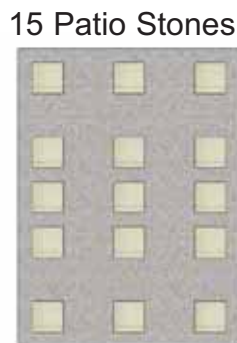

Gravel Foundation with Patio Pavers



Completed Foundation

Gravel with Patio Paver Stones:

- Excavate at least 6" deep, and 6" wider than floor frame on each side.
- 1.4 Cubic Yards of gravel required, approximately 13 wheelbarrows.
- 15 patio pavers (8" x 8" or larger).
- Center patio paver stones underneath floor runners and underneath seams in floor joists.

Patio paver stones are widely available from most landscape stores.

Thank you for purchasing our 9x6 Cabana.

Please take the time to identify all the parts prior to assembly.

Parts List:

A. Floor Section

- 3 - 35" x 75" - Floor Joist Frames
- 2 - 48" x 74 7/8" - Plywood Floor - Large
- 1 - 8 7/8" x 74 7/8" - Plywood Floor - Small
- 4 - 1 1/2" x 3 1/2" x 71 7/8" - Floor Joists
- 3 - 1 1/2" x 3 1/2" x 57" - Floor Runners - Long
- 3 - 1 1/2" x 3 1/2" x 48" - Floor Runners - Short

B. Wall Section

Main Wall Panels

- 7 - 35" w x 75" h - Solid Wall Panels
(7 walls with Bottom Plates Unattached)
- 7 - 1 1/2" x 2 1/2" x 35" - Bottom Wall Plates
- 2 - 35" x 75" - Window Wall Panels

Door Jambs & Header

- 2 - 1 1/2" x 3 1/8" x 73" - Vertical Door Jambs
- 1 - 2" x 3 1/8" x 35" - Door Header (Notch on edge)

Top Wall Plates

- 4 - 3/4" x 2 1/2" x 50" - Front & Rear Top Wall Plate (Angle cut on edge)
- 2 - 3/4" x 2 1/2" x 75" - Side Top Wall Plate (Angle cut on ends)

Gable Walls

- 2 - Side Gable Walls - Triangular shaped

C. Rafter and Roof Section

- 18 - 1 1/2" x 3 1/2" x 45" - Rafters (angle cut)
- 2 - 3/4" x 4 1/2" x 44" - Ridge Boards
- 2 - 3/4" x 4 1/2" x 61" - Ridge Boards
- 4 - 1/2" x 4 1/2" x 52 1/2" - Soffits (Front and Rear)
- 3 - 3/4" x 3 1/2" x 48" - Roof Gussets (angle cut on ends)

Roof Panels

- 4 - Outside Roof Panels 40 1/2" wide x 47 7/8" long
(Shingles overhanging roof plywood on 1 end)
- 2 - Middle Roof Panel 35" wide x 47 7/8" long
(Shingles flush with roof plywood)

Filler Shingles

- 12 pcs - Long
- 4 pcs - Short

D. Trim and Miscellaneous Section

Bottom Skirting

- 10 - 1/2" x 4 1/2" x 34 3/4" - Bottom Skirting

Corner & Wall Trim

- 8 - 5/8" x 2 1/2" x 36" - Filler Trims
- 4 - 1/2" x 4 1/2" x 32 3/4" - Horizontal Gable Trims
- 4 - 1/2" x 3 1/2" x 79" - Corner Trims
- 4 - 1/2" x 5 1/2" x 82" - Wide Corner Trims
- 2 - 1/2" x 2 1/2" x 79" - Rear Wall Narrow Trims
- 2 - 1/2" x 2 1/2" x 77 1/4" - Side Wall Narrow Trims

Facia Trim

- 4 - 3/4" x 2 1/2" x 44 1/2" - Facia Nailing Strips
- 4 - 3/4" x 3 1/2" x 45 7/8" - Side Facia (Angle cut both ends)
- 4 - 3/4" x 3 1/2" x 57 1/4" - Front & Rear Facia (square cut)
- 2 - 1/2" x 3 1/2" x 8" - Facia Detail Plate Pieces (front and rear)
- 2 - 1/2" x 4 1/2" x 8" - Horizontal Gable Trim Detail Plates
- 2 - 1/2" x 5 1/2" x 8" - Pentagon Facia Plates (sides)

Door

- 2 - 1/2" x 3 1/2" x 79" - Vertical Door Trims
- 1 - 1/2" x 1 1/4" x 32" - Horizontal Door Trim
- 1 - 31 1/2" x 42" - Bottom Dutch Door Section
- 1 - 31 1/2" x 30" - Top Dutch Door Section
- 2 - 1/2" x 2 1/2" x 72" - Interior Vertical Door Stops
- 1 - 1/2" x 2 1/2" x 36" - Interior Top Horizontal Door Stop

Ridge Caps

- 1 Bundle Cedar Shingle Roof Ridge Caps - 18 pcs

**Miscellaneous Pieces

- 1 pc - Spare Wall Siding
- 2 - Window Inserts
- 2 - Window Trim Pkg - (1-24 1/16" angle cut / 3-23" square cut)
- 2 pcs - Shim Shingles - use to shim door, etc
- 2 - Flower Box Kits

Note: All Trim, Facia and Bottom Skirting pieces will be positioned rough face out when installed.

9X6 CABANA HARDWARE PACKAGE

Hardware Kit (Provided)

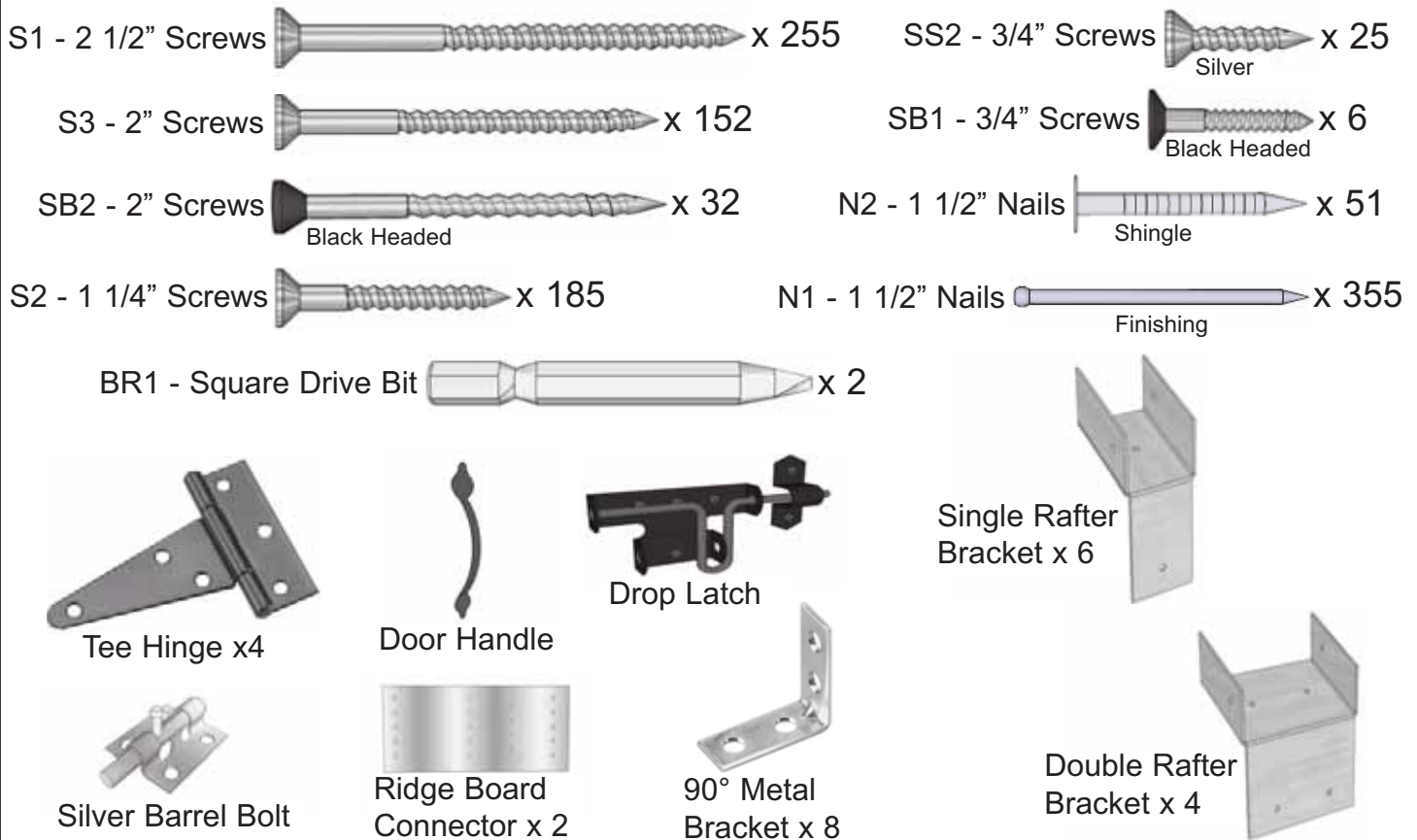

Tools Required (Not Provided)



Safety Equipment Required (Not Provided)



Before/During Assembly:

- 1.) Paint each face and edge of your plywood floor with a latex exterior paint.
- 2.) Caulk wall seams if gaps appear.
- 3.) Caulk around window framing.
- 4.) Caulk perimeter between floor plywood and bottom wall plate.
- 5.) Caulk channels in lap siding at the top of your door above the trim, just a drop in each channel.
- 6.) Caulk edge of door threshold (if applicable).
- 7.) Optional: Install a Sill Gasket between floor runners and foundation.
- 8.) Optional: Install an 8" strip of roofing paper below Cedar Ridge Caps for Cedar Roof Sheds.

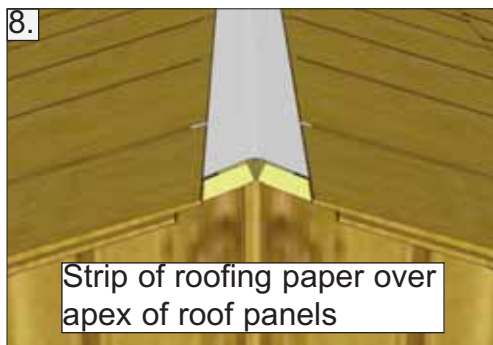
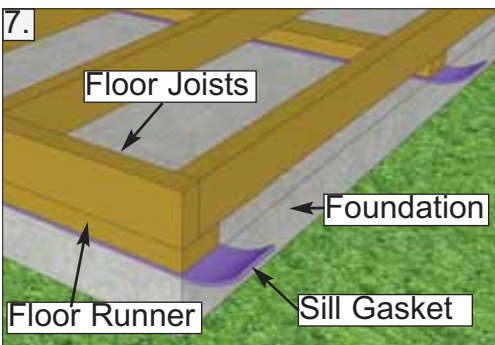
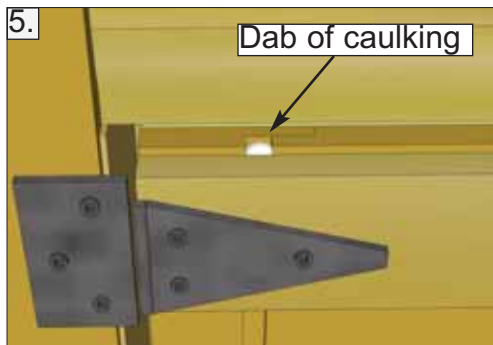
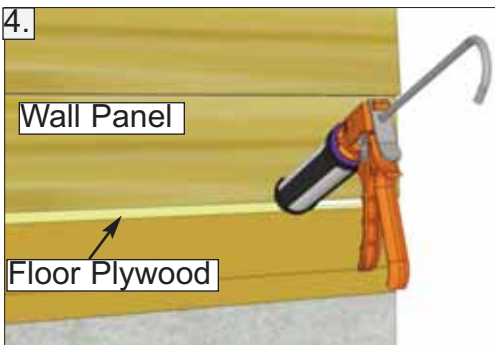
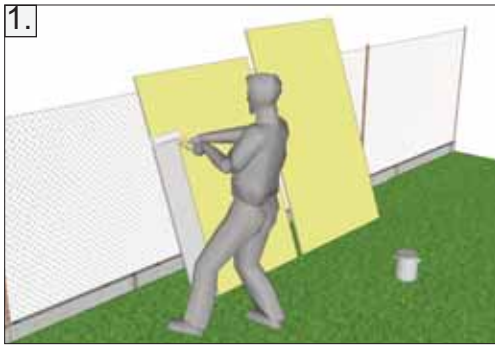

Routine Maintenance:

- Routinely check all fasteners are tight (ex. Door Hinges, Nails)
- Brush off dirt from walls.
- Brush off snow from roof regularly.
- Routinely remove needles and leaves from roof.

Painting/Staining

- Your cedar shed, if left untreated, will weather to a silvery grey colour.
- Painting or staining your structure is highly recommended and will prolong the life of your shed.
- You do not need to wait to paint or stain your shed, the wood in your kit has been dried and can be stained or painted immediately.
- Consult your local paint store for the best paint or stain for cedar.
- Optional: stain the inside of your shed. (Note: this will remove the fresh cedar smell.)

A. Floor Section

Exploded view of all parts necessary to complete Floor Section. Identify all parts prior to starting.

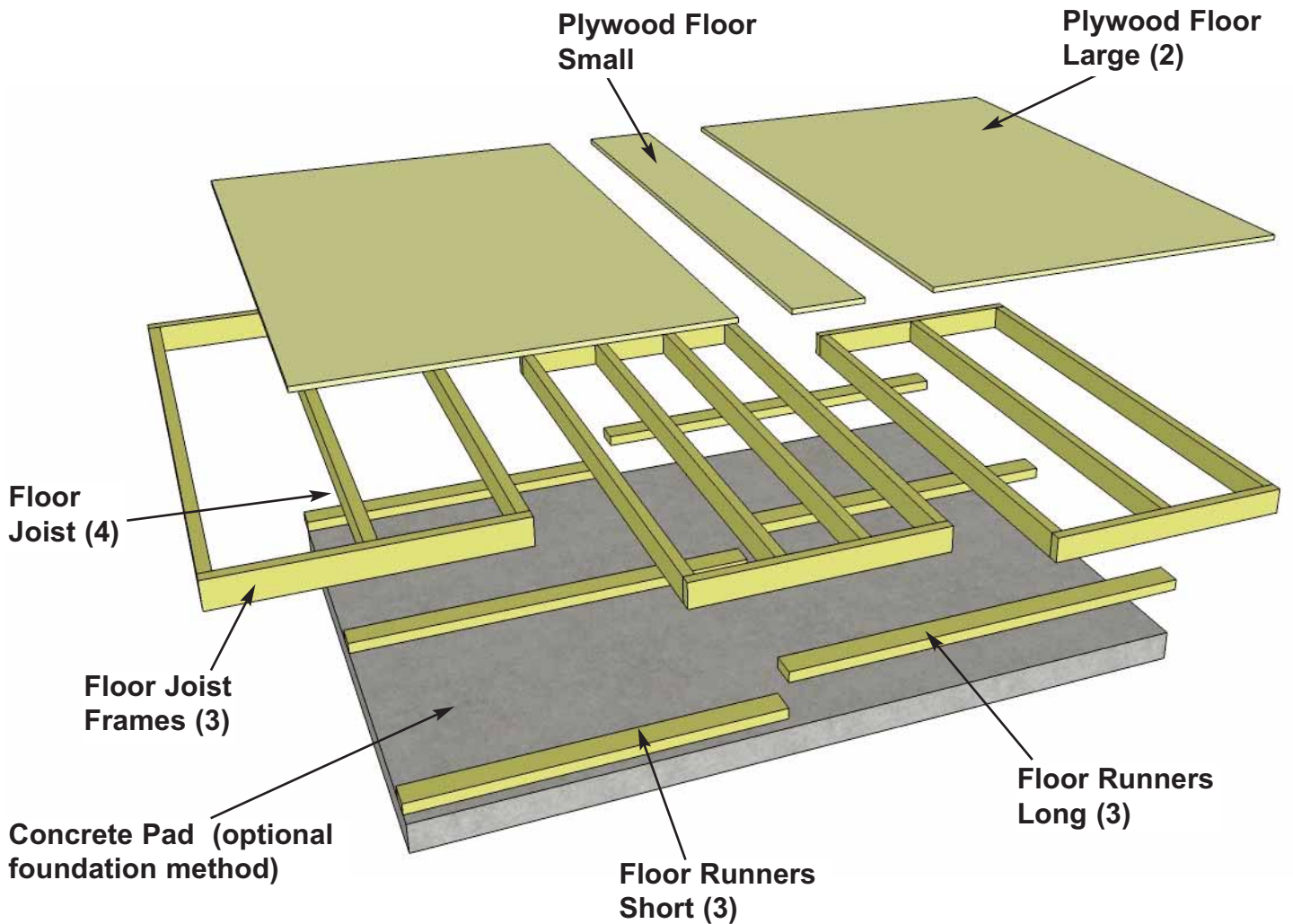

You can find the Square Drive Bit for the screws in with the Hardware Kit Bag.

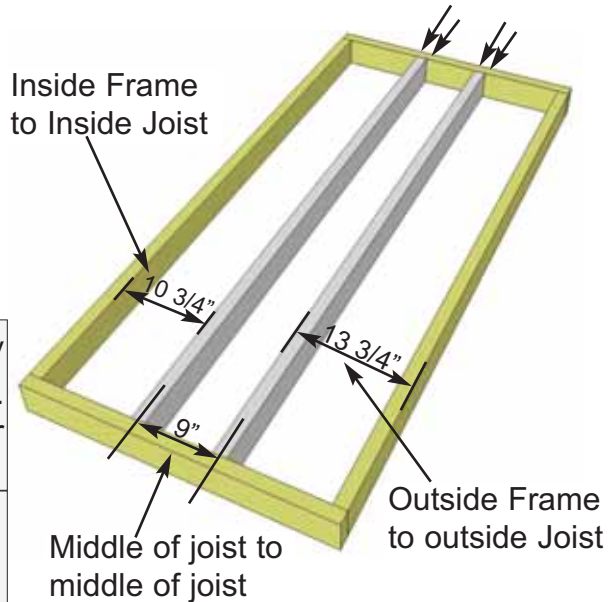

1. Attach Interior **Floor Joists** to **Floor Joist Frames**. Only the Center Floor Joist Frame requires 2 Joists to be attached. Measure and attach both Joists with **2 - 2 1/2" Screws** per Joist end as illustrated to the right.

Parts (Steps 1 - 3)	Hardware (Steps 1 - 3)
Floor Joists (1 1/2" x 3 1/2" x 71 7/8") x 4 Floor Joist Frames (35" x 75") x 3	S1 - 2 1/2" Screws x 28 total

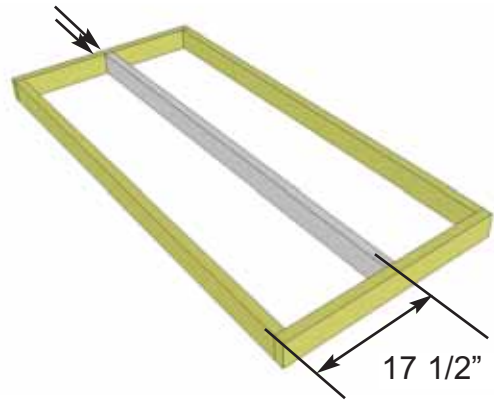
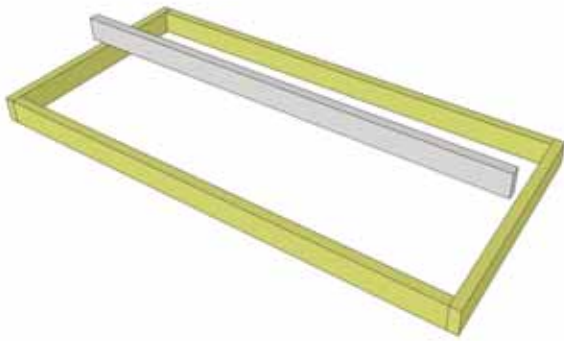

2. Both Outside **Floor Joist Frames** require **1 Floor Joist** attachment. Center Joist **17 1/2"** from Outside of Floor Joist Frame and attach with **2 - 2 1/2" Screws** per end.

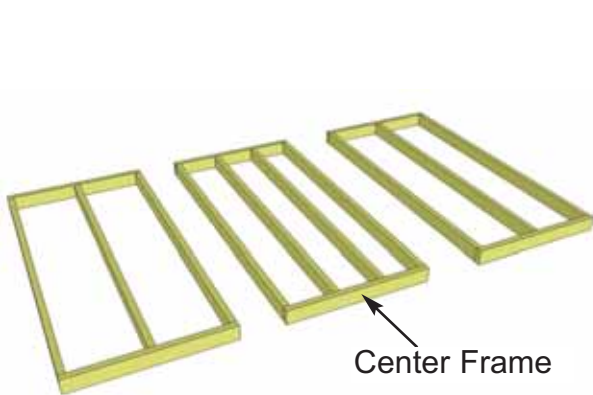

3. Position completed Floor Joist Frames with center frame in the middle. Attach the Floor Joist Frames together with **6 - 2 1/2" Screws** per section. When completed, your floor joist section should be **105" wide x 75" deep**.

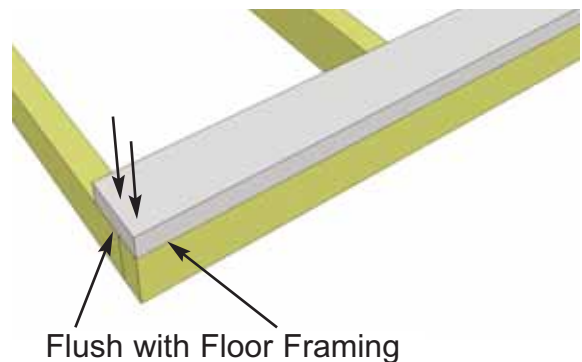
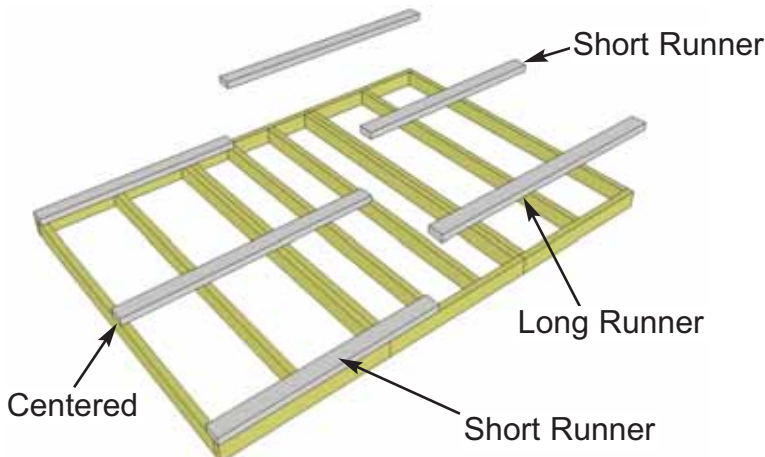
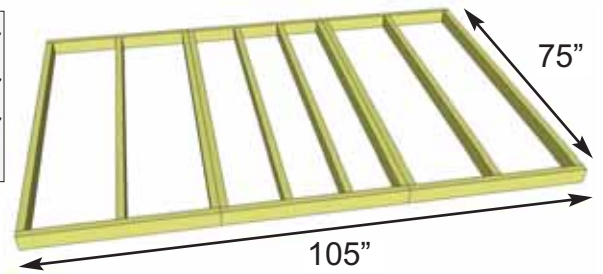

4. Attach **Long & Short Floor Runners** to completed floor frame. There are 2 floor runners per 105" side and 3 completed Runners in total. Each completed Runner will have a long and short piece. Use **10 - 2 1/2" Screws** to secure long Runners and **8 - 2 1/2" Screws** to secure short Runners. Reverse long and short position of centre Runner to provide more floor strength.

<u>Parts</u>	
Floor Runners - Long (1 1/2" x 3 1/2" x 57") x 3	
Floor Runners - Short (1 1/2" x 3 1/2" x 48") x 3	
<u>Hardware</u>	
S1 - 2 1/2" Screws x 54 total	



Concrete Slab Foundation

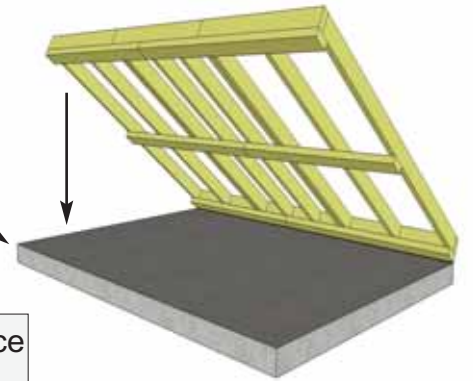

5. With Floor Runners attached, carefully flip the floor over and place on your foundation. **Caution:** you will need 2 people to assist you. Be careful when laying floor down not to bend or twist floor. When in place, level floor completely.

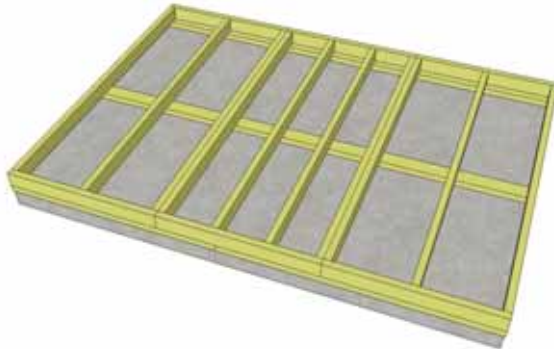

Foundations

Note: The floor will be flipped over and floor runners will sit on your foundation. It is important to note that having a level foundation is critical. Choosing a foundation will vary between regions. Typical foundations can be concrete pads or patio stones positioned underneath the floor runners.

6. Position all **Large & Small Plywood Floor** pieces on top of completed Floor Joists. Plywood will sit slightly back from outside edge of Floor Joist Framing. When in correct position, attach with **1 1/4" Screws**. Use screws every 16". The Plywood is cut slightly smaller than floor framing. Keep plywood seams tight.

Parts
Plywood Floor - Large
 (48" x 74 7/8") x 2
Plywood Floor - Small
 (8 7/8" x 74 7/8") x 1

Hardware
S2 - 1 1/4" Screws
 x 40 total (approx)

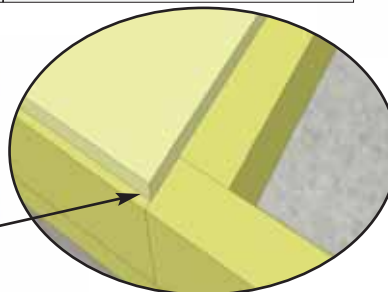
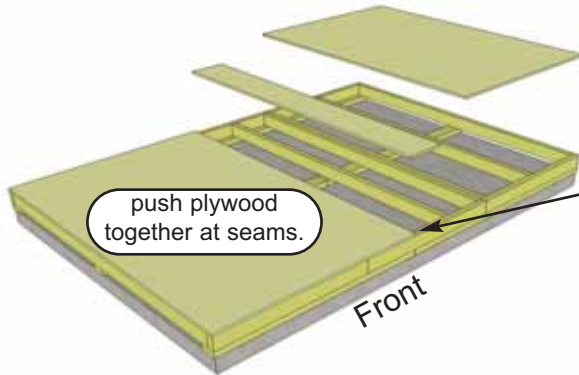
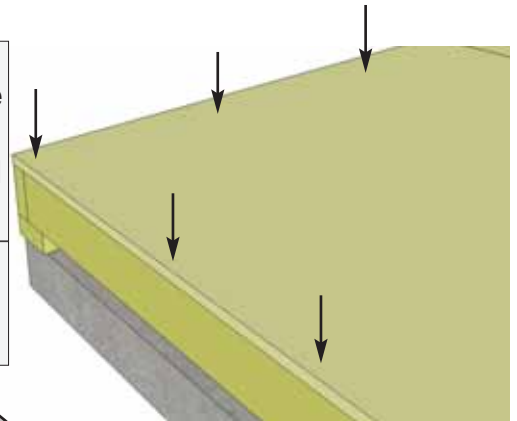

Hint: Use a chalk line to mark location of floor joists to determine screw placement.



7. When completed, make sure the floor is still level and make adjustments if required. When completed, your floor should look similar to this.

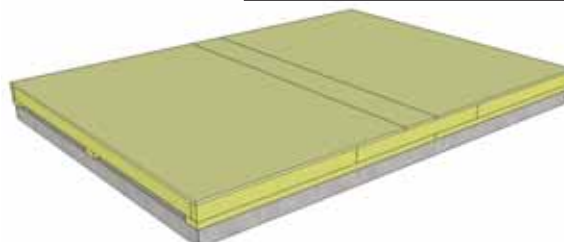

Important - Make sure floor is level before moving on to wall section. Use a level to confirm, and shim floor joists as required.

Important: The following steps in assembly are shown with bevel sided walls. Assembly instructions for different siding types are interchangeable.

B. Wall Section

Exploded view of all parts necessary to complete the Wall Section. Identify all parts prior to starting.

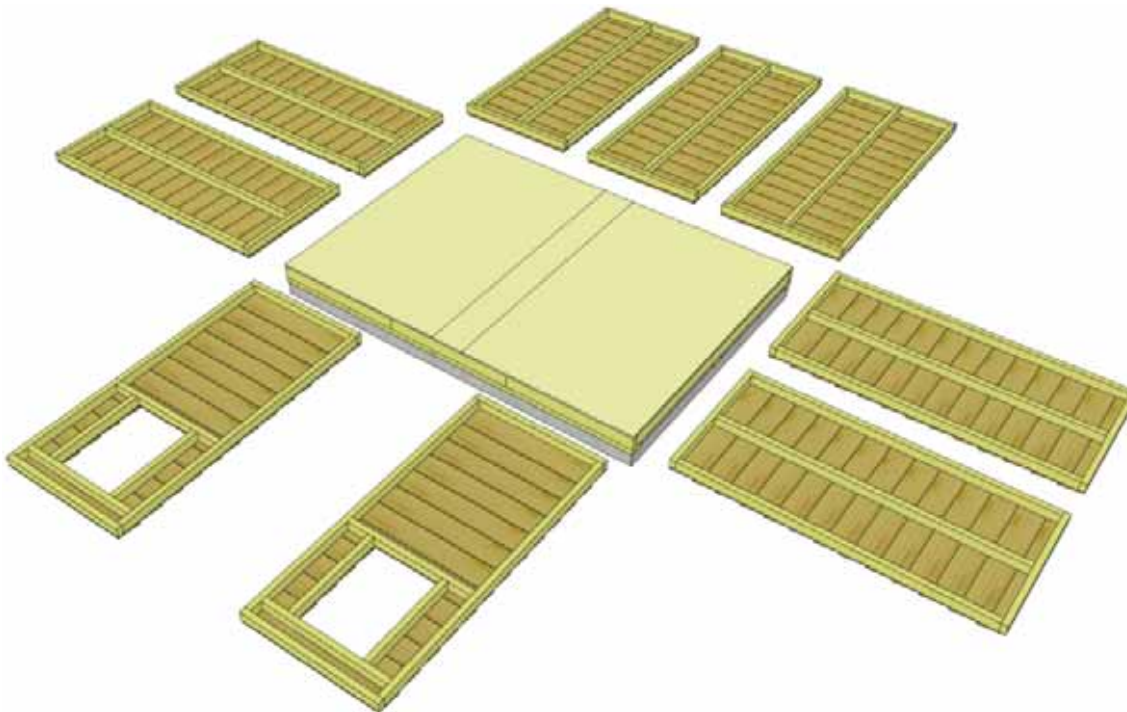
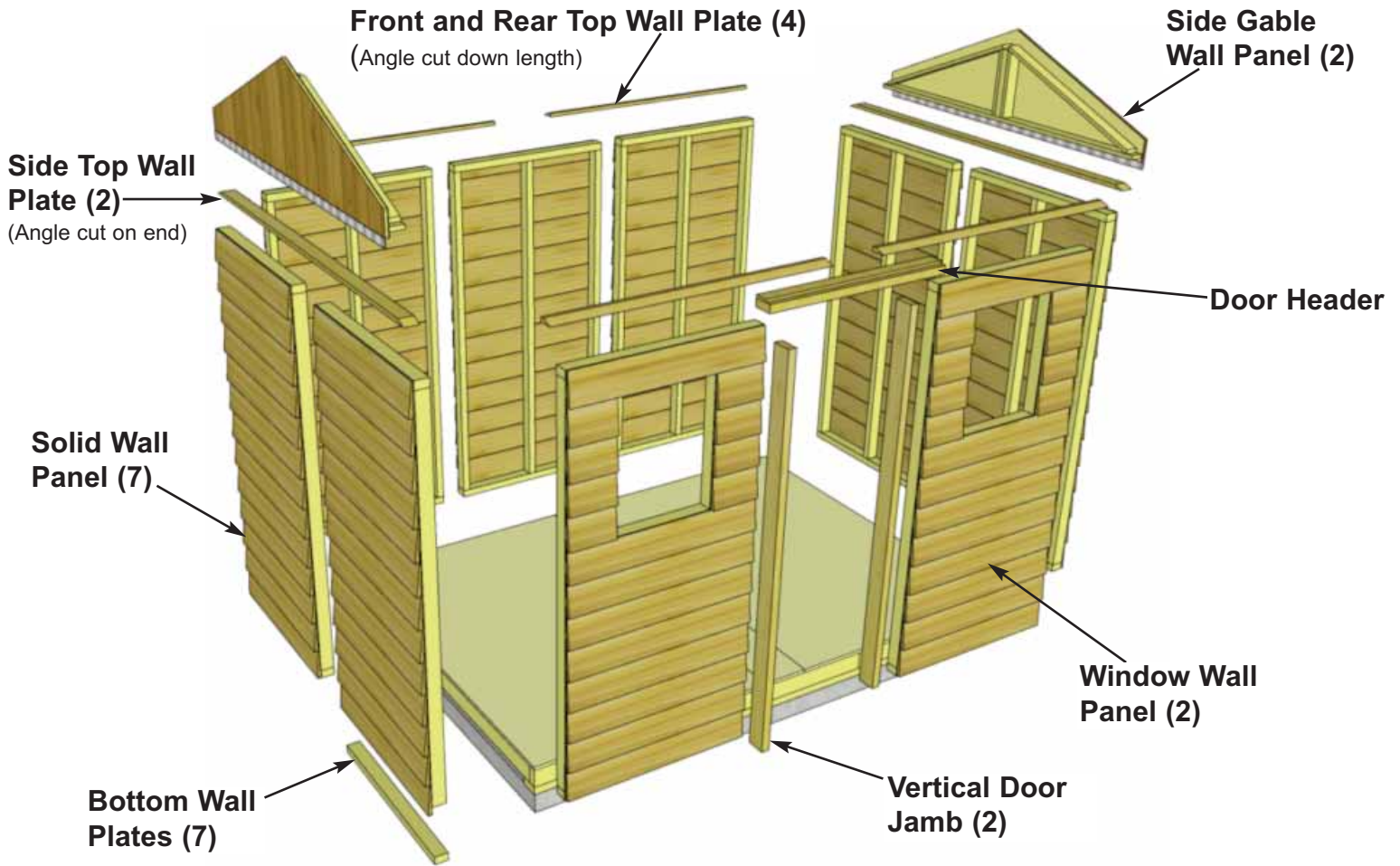

8. Lay out all the wall panels and become familiar with their location. On Standard Kits, there are **2 Window Wall Panels** and **7 Solid Wall Panels**.

Make sure panels are in upright position so water is directed away from and not into shed. Compare siding of solid panels with window wall panels to determine if in upright position.

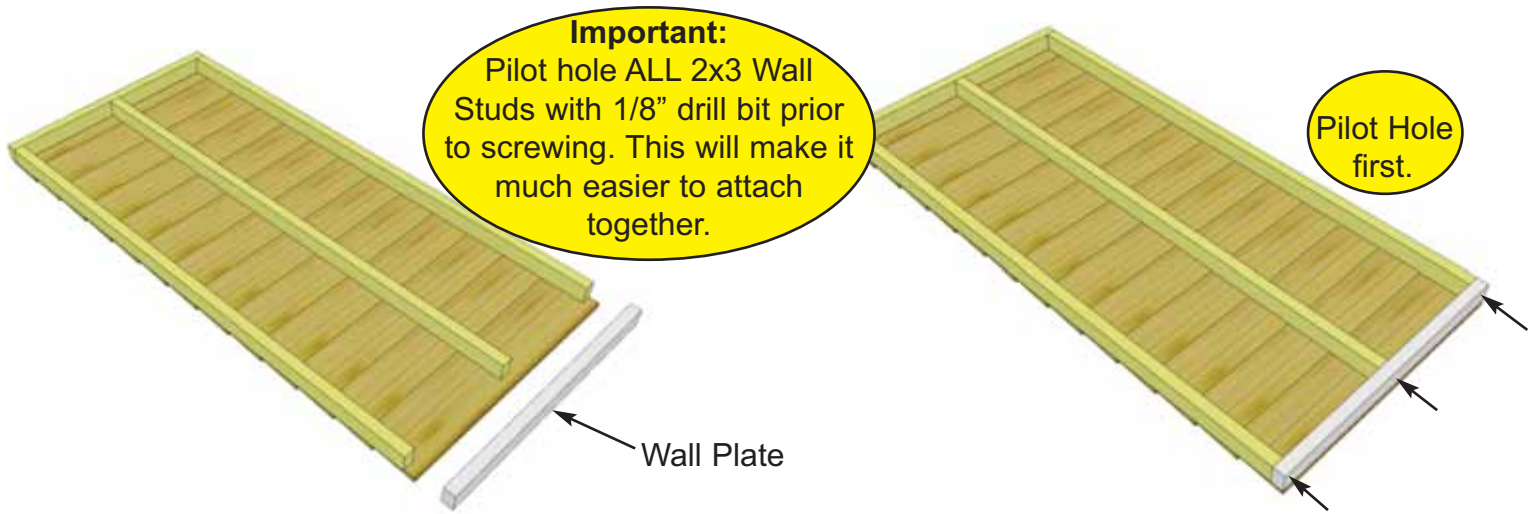

9. Starting with **Solid Wall Panels**, carefully lay panel face down. Position and attach a **Bottom Wall Plate** to bottom of wall studs of each wall panel with **3 - 2 1/2" Screws**. Position so plates are flush with framing.

Parts	Hardware
Solid Wall Panels (35" x 75") x 7	S1 - 2 1/2" Screws x 21 total
Bottom Wall Plates (1 1/2" x 2 1/2" x 35") x 7	

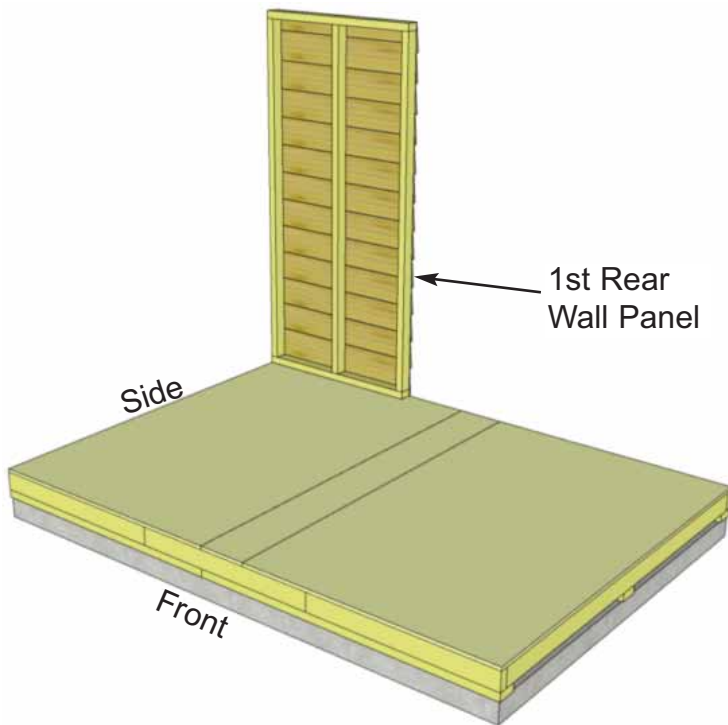

10. Starting at Rear Corner, position a Solid Wall Panel on top of plywood floor. Depending on your preference, you may use a solid or window wall panel in this position. If using a solid wall, make sure panel is facing up.

Important - Make sure all walls are aligned in their upright position. If not, water may leak into your shed. Unsure if panel is facing up or down? Compare solid wall siding to window wall siding and match orientation.

11. The Front and Rear Wall Panels will sandwich the Side Panels. **Note:** 2x3 wall frame will sit flush with floor frame, siding will overhang the floor horizontally by approximately 1/2".

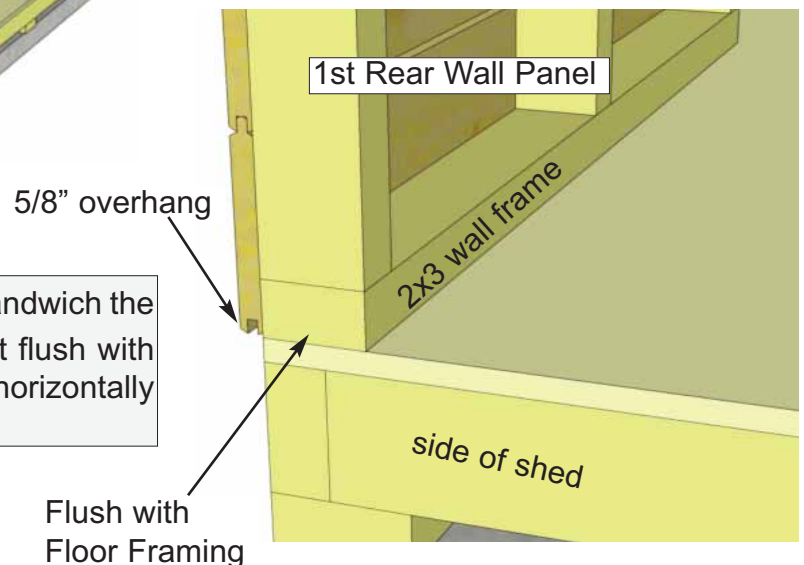

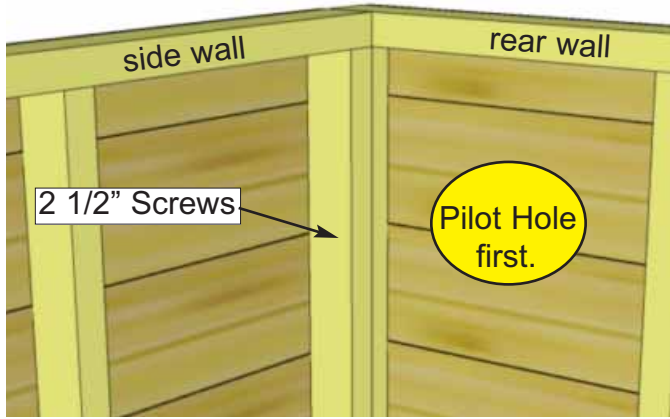

Optional - Caulking seams will help prevent moisture from entering your shed. **Caulking not included in kit.**

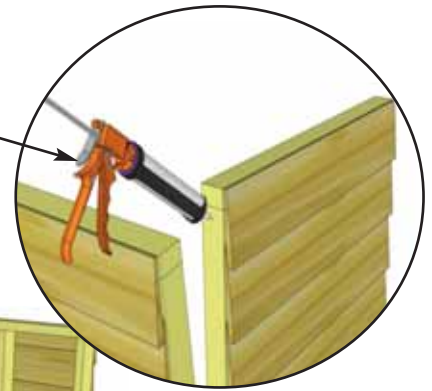

12. Position 1st side wall panel on plywood floor so once again 2x3 bottom wall plate is sitting flush with floor framing. Position panel so vertical 2x3 framing sits flush with rear wall framing. When both wall panels are positioned correctly, attach together at top, middle and bottom of vertical studs with **3 - 2 1/2" Screws**.

Hardware (Steps 12 - 16)

S1 - 2 1/2" Screws x 18 total

Side Wall Panel

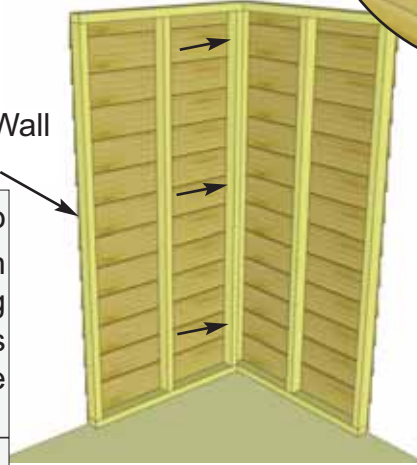

Important - Do not fasten walls to floor until Step 20.

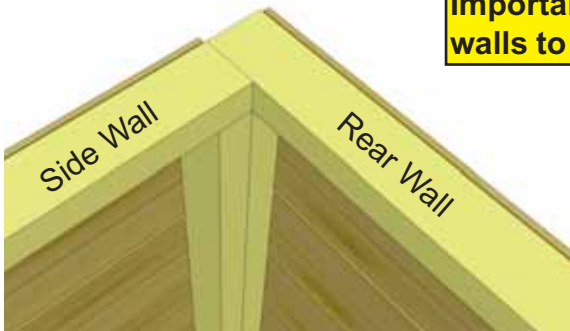

13. When correctly aligned, looking from the top view, 2x3 wall framing of corner wall panels will be positioned as illustrated above.



14. Position and attach 2nd rear wall panel as shown above. Attach adjacent wall studs together with **3 - 2 1/2" Screws**.

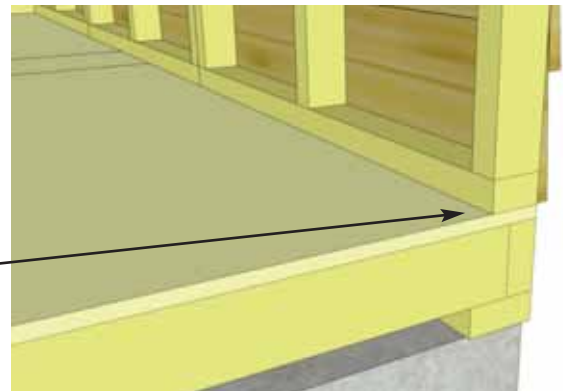

15. Position and attach 3rd rear wall panel and attach as per **Step 14**. **Note:** wall framing of 3rd rear wall should sit flush with floor framing.

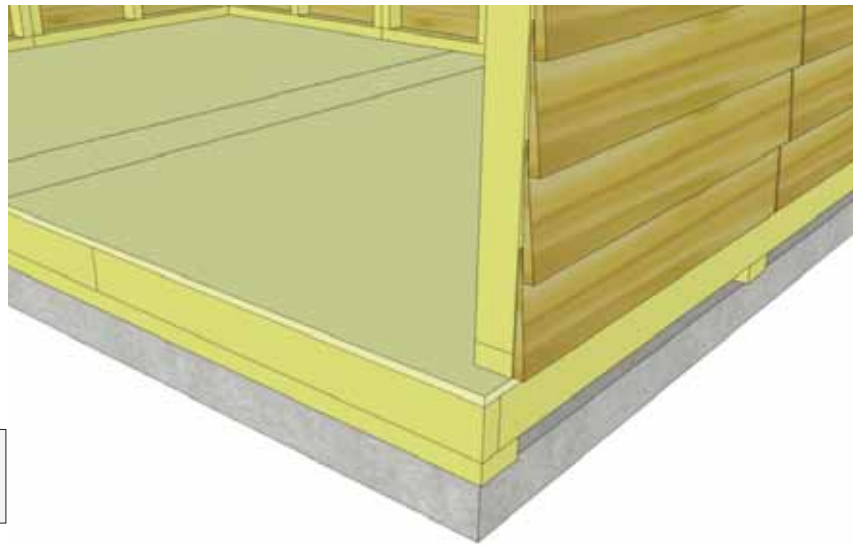

16. Complete attachments of remaining side walls as per **Steps 11 - 15.**

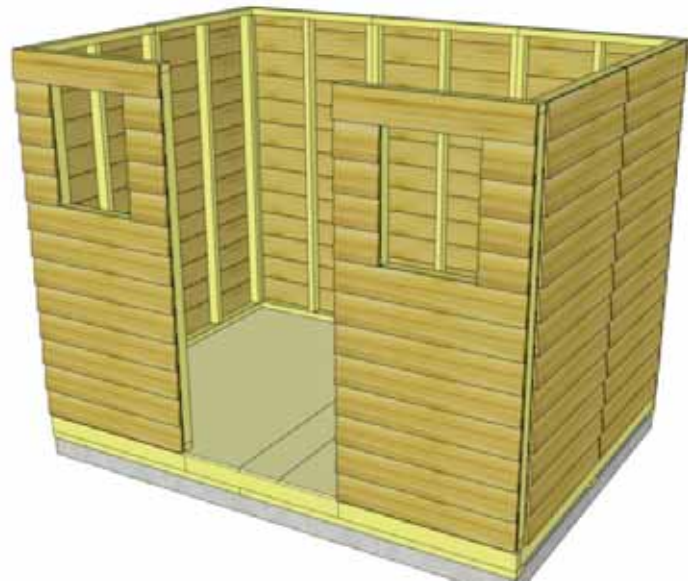
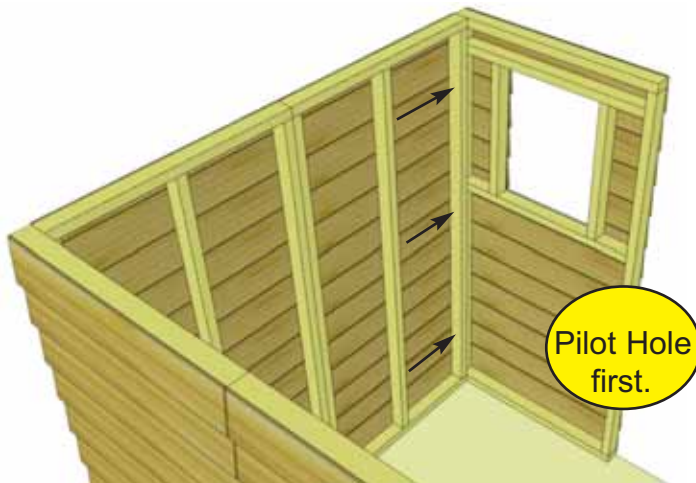

17. Position and attach both Window Walls as per **Steps 11 - 15.**

Parts	Hardware
Window Walls (35" x 75") x 2	S1 - 2 1/2" Screws x 6 total

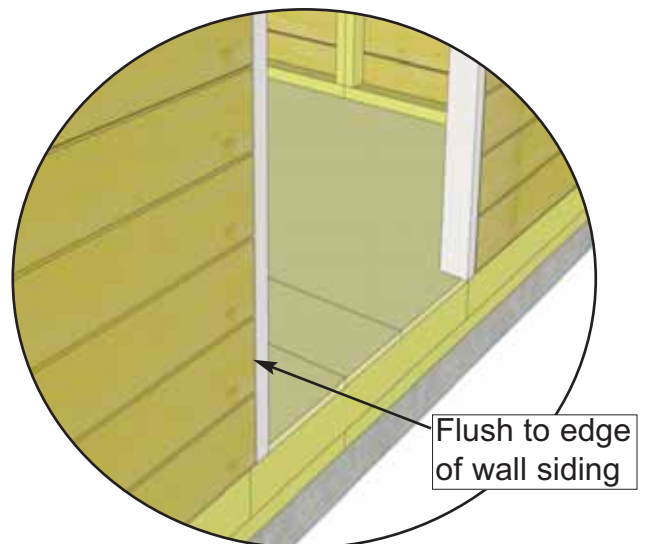
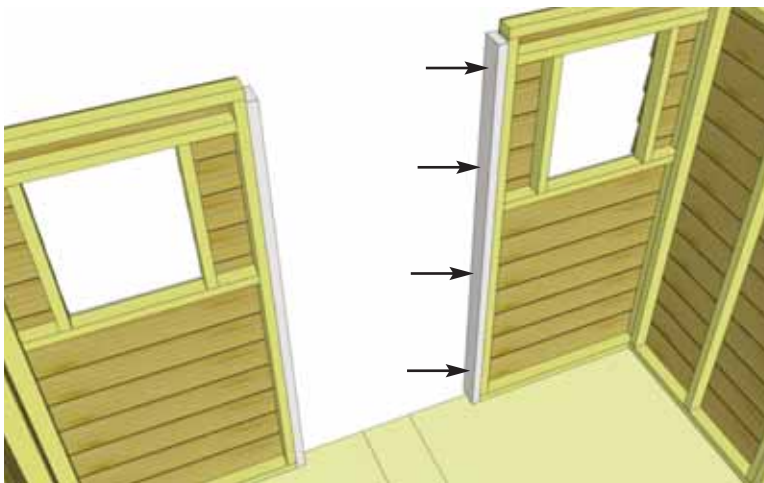

18. Attach both **Vertical Door Jambs** to door opening wall studs with **4 - 2 1/2" Screws** per Jamb. Position so jamb is flush with tip of bevel siding on front window walls.

Parts	Hardware
Vertical Door Jambs (1 1/2" x 3 1/8" x 73") x 2	S1 - 2 1/2" Screws x 8 total

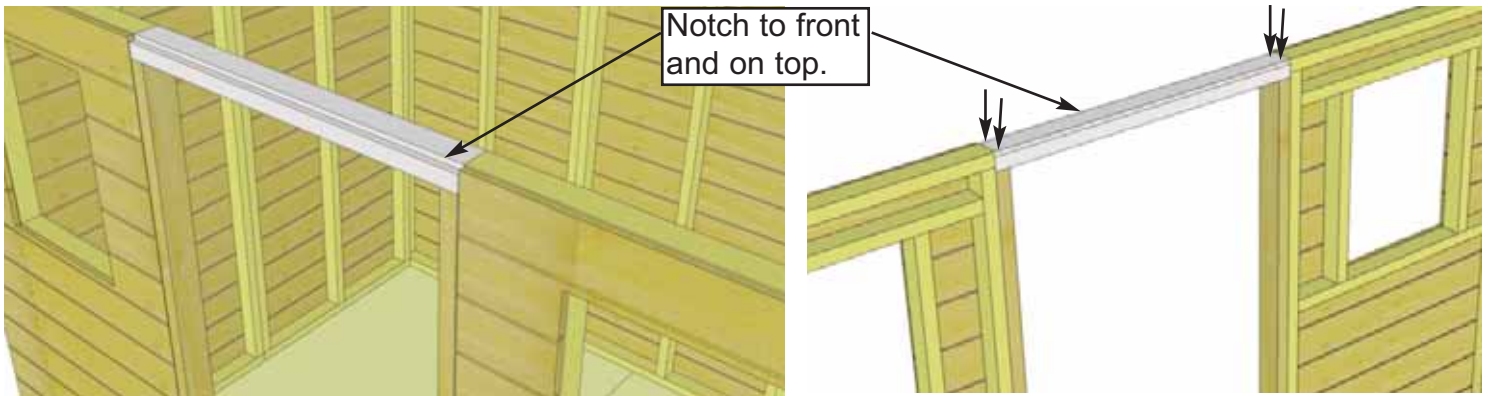

19. Attach **Door Header** to vertical door jambs with **2 - 2 1/2" Screws** per side. Header is 3 1/8" wide at bottom and has a 1/2" thick x 2 1/2" wide strip of wood stapled to the top creating a notch or dado effect. This notch needs to be positioned on the top facing the front. The notch is necessary as the roof panel may hang up on the header and must sit flush on the rafter tops when attached. **Screw from door header into door jambs with 4 - 2 1/2" Screws (2 per side). Pre-drill to prevent splitting!**

<u>Parts</u> Door Header (2" x 3 1/8" x 35") x 1
<u>Hardware</u> S1 - 2 1/2" Screws x 4 total

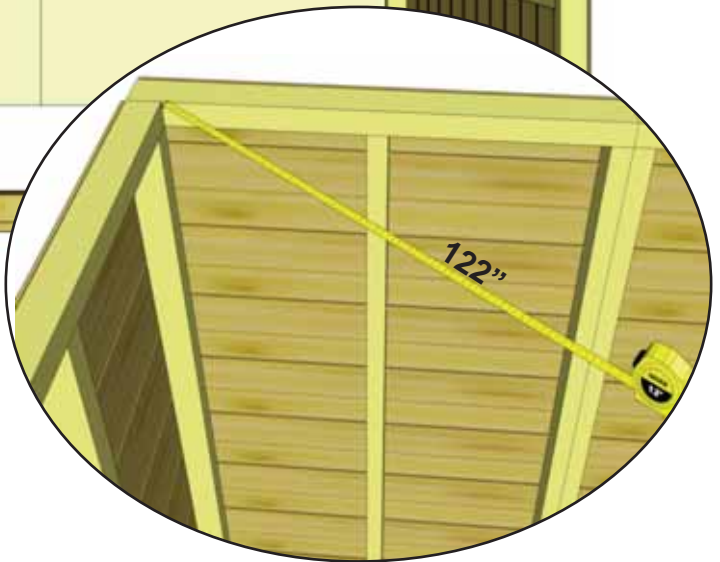
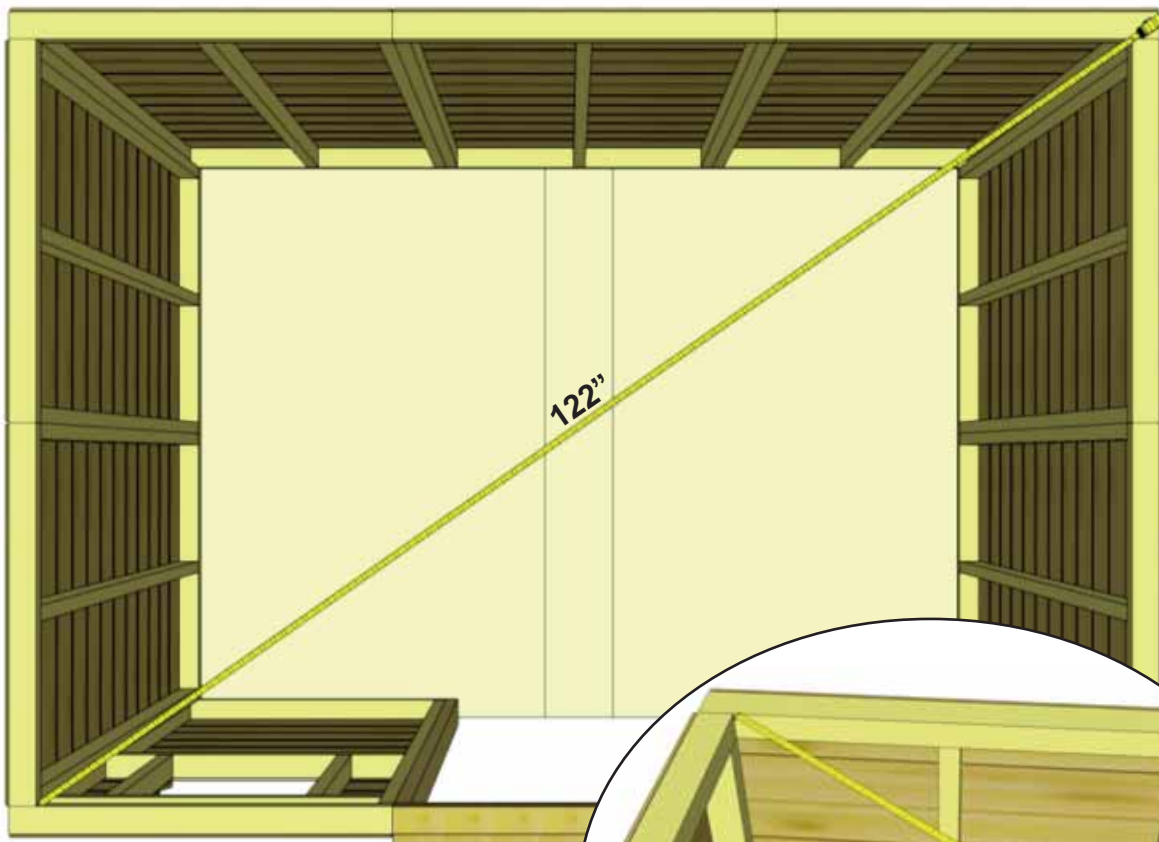

Advice: Prior to fastening walls and installing rafters, take time to confirm your walls are level, square and plumb.

Measure diagonal at top and bottom of walls corner-to-corner. This should be approximately 122". More importantly, if measurements are not within 1/4", your walls are not square. Adjusting now will make it easier to install roof section.



Optional - Caulking seams will help prevent moisture from entering your shed. **Caulking not included in kit.**

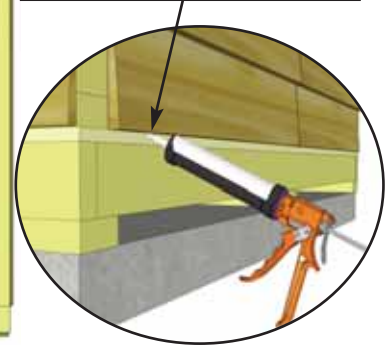

20. When all walls are attached together, check alignment with the floor. Bottom of wall frames should sit flush with outside of floor framing, with siding overhanging by approximately 1/2". Confirm 32" wide door opening at bottom. When positioned correctly, fasten bottom wall plates to floor using **4 - 2 1/2" Screws** per wall panel.

Hardware
S1 - 2 1/2" Screws
 x 36 total

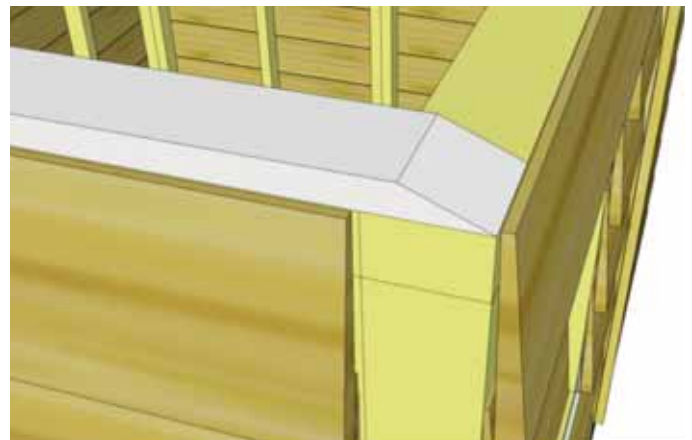
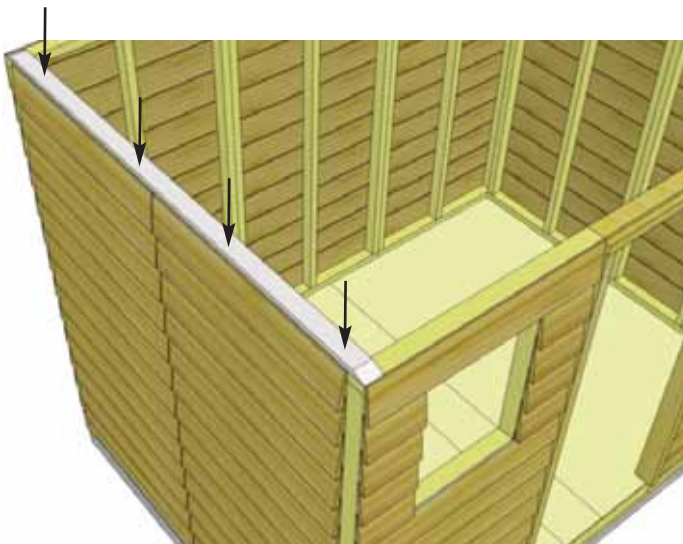

21. Position a **Side Top Plate** on top wall framing so they are flush. Attach by screwing down into top of wall frame with **4 - 2" Screws**.

Parts (Steps 21 - 22)

Side Wall Top Plates - Angle Cut Ends
 (3/4" x 2 1/2" x 75") x 2

Front & Rear Wall Top Plates - Angle Cut Edge
 (3/4" x 2 1/2" x 50") x 4

Hardware (Steps 21 - 22)

S3 - 2" Screws
 x 24 total

Front Top Plate

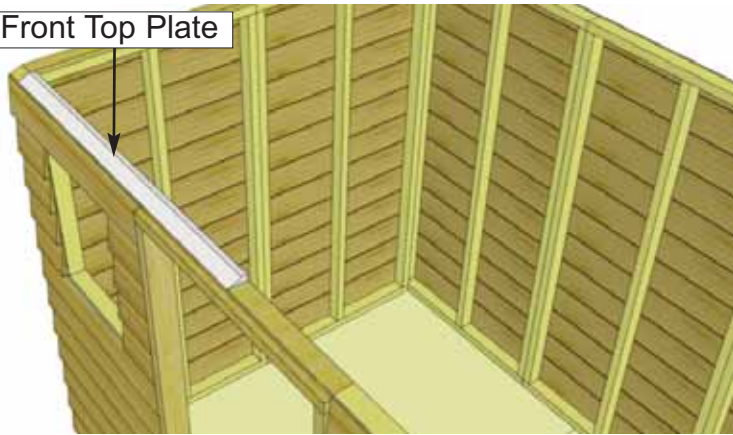

22. Next, attach the **Front Top Plates**. The Front and Rear Top Plates are angle cut down the length. Once again, position Top Plates on wall frame so they are flush. Front and Rear Top Plates will fit between Side Top Plates. Attach with **4 - 2" Screws** per plate. Complete all other **Side & Rear Top Plate** attachments.

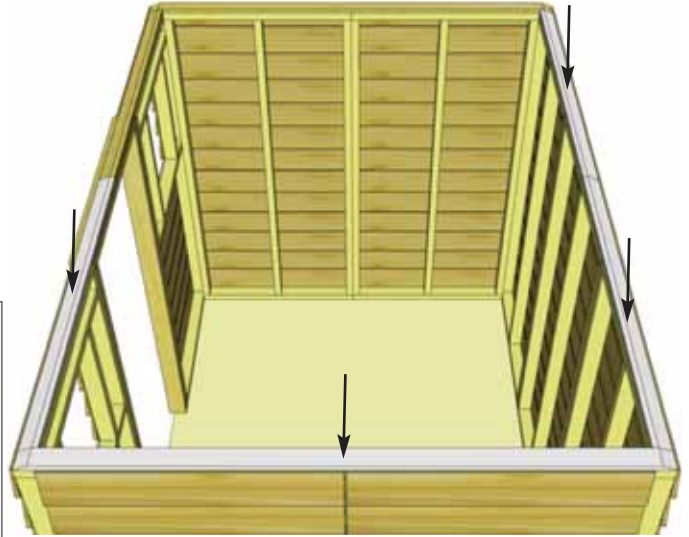

23. Place **Side Gable Wall** so 1x3 framing sits flush with the inside of the Top Plate. It should also be centered sideways on the Top Plate. Adjust Gable accordingly. Temporarily attach to Walls and Top Plate with **2 - 2" Screws**. Gables may need slight adjustment in **Step 34** when attachment will be completed with an additional 6 Screws. Screw from the bottom of Gable framing down into Top Plate and Wall. **Hint:** Use a straight edge to check the angle of the Gable framing and Top Plate. Both angles should line up (see diagram below).

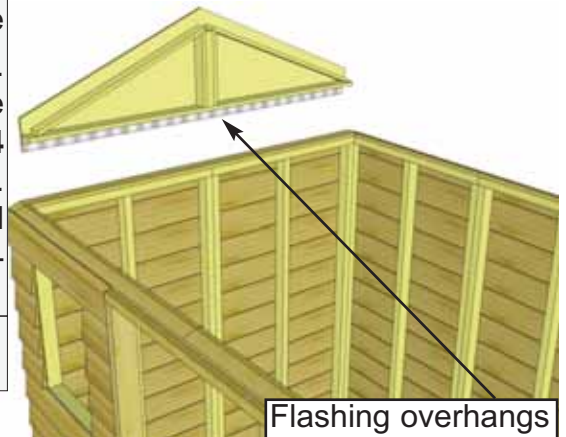

Flashing overhangs wall on outside.

Parts (Steps 23 - 24)
Side Gable Walls x 2

Hardware (Steps 23 - 24)
S3 - 2" Screws x 4 total

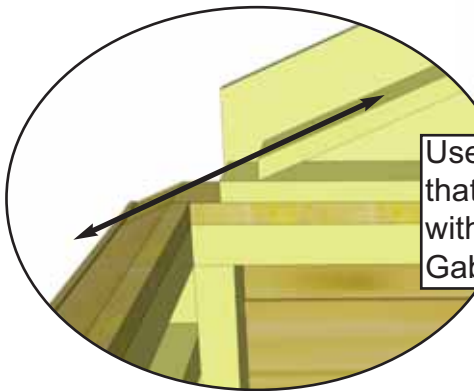

Use a straight edge to check that angle of Gable lines up with Top Plate angle. Adjust Gable for best fit.

24. Align and attach opposite Side Gable Wall as per **Step 23**. Flashing will overhang Wall on outside.



C. Rafter and Roof Section

Exploded view of all parts necessary to complete the Roof Section.
Identify all parts prior to starting.

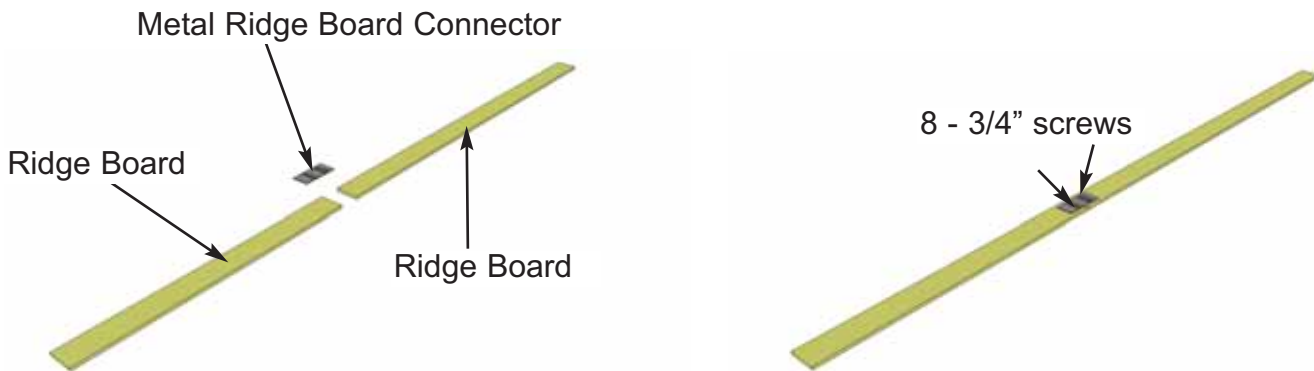
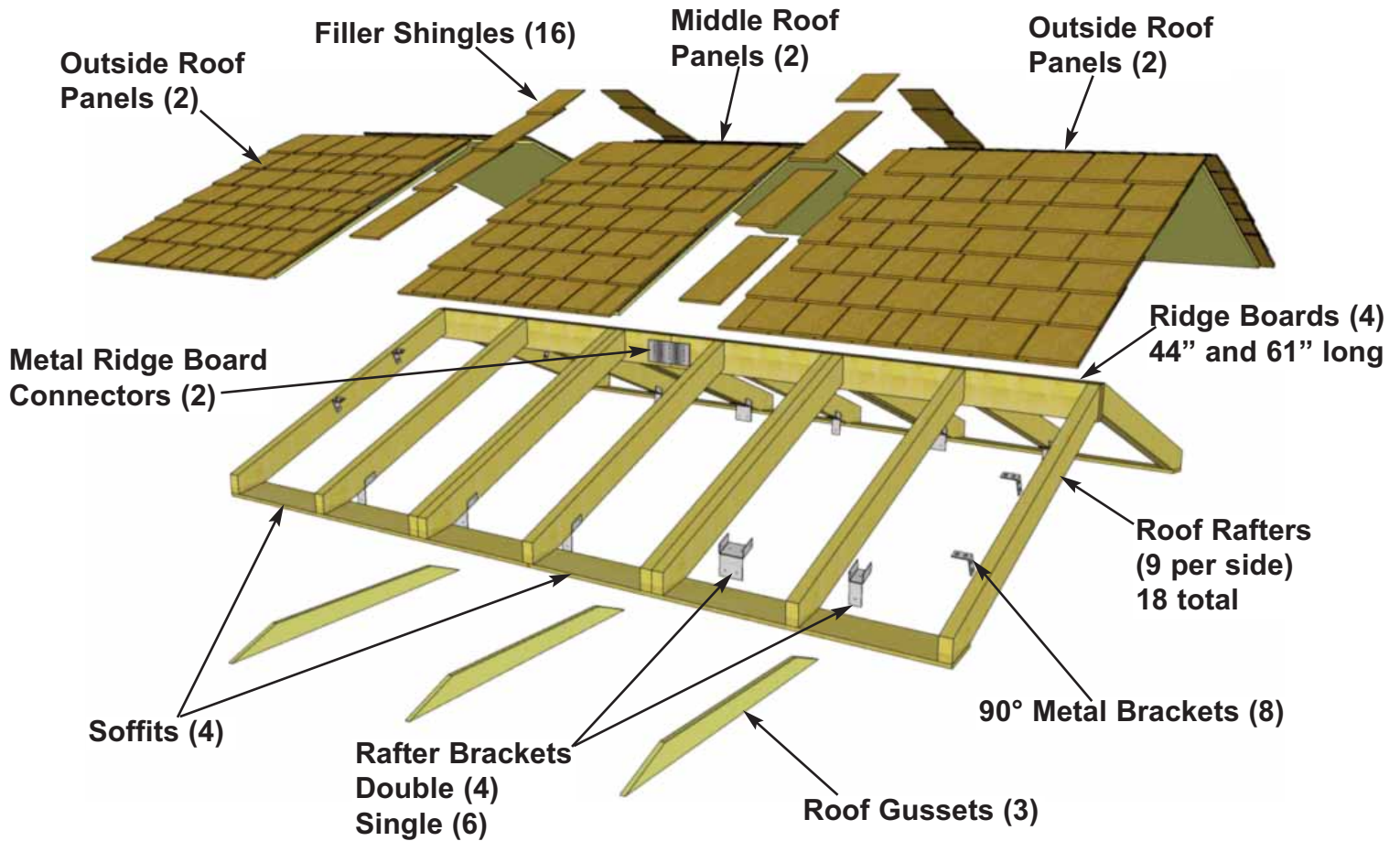

25. Locate (1 each) **Long & Short Ridge Boards** and attach together with a metal **Ridge Board Connector** using **8 - 3/4" Screws**. Total Length when connected is 105". Connect other set of Ridge Boards the same. Position metal Ridge Board Connector evenly on Ridge Boards.

Parts
Ridge Boards - Long (3/4" x 4 1/2" x 61") x 2
Ridge Boards - Short (3/4" x 4 1/2" x 44") x 2

Hardware
SS2 - 3/4" Screws x 16 total
Y9 - Ridge Board Connector x 2 total

26. Locate 9 **Rafters**, 2 **Soffits** and a completed Ridge Board. Lay out on level ground as shown to the right. Double up Rafters as illustrated. Screw doubled up Rafters together with **3 - 2 1/2" Screws** per piece.

Parts (Steps 26 - 28)	Hardware (Steps 26 - 28)
Rafters (1 1/2" x 3 1/2" x 45") x 18	S1 - 2 1/2" Screws x 12 total
Soffits (1/2" x 4 1/2" x 52 1/2") x 4	S2 - 1 1/4" Screws x 36 total
	S3 - 2" Screws x 36 total

Doubled up Rafters - screw together with 3 - 2 1/2" Screws.

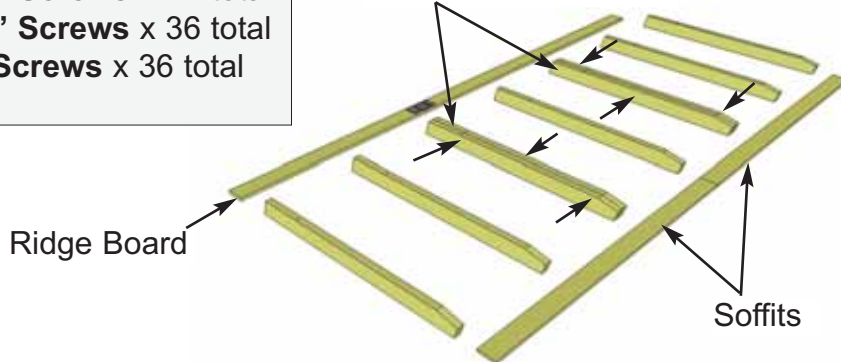

Important: Pilot Hole Ridge Board to prevent splitting!

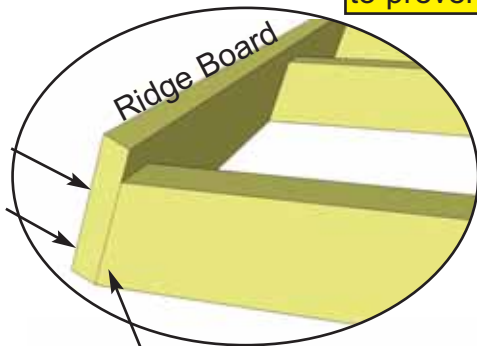

27. Attach completed Ridge Board to ends of both outside Rafters with **2 - 2" Screws** per end. Measure and position interior Rafters as illustrated below. When positioned correctly, attach Ridge Board to remaining Rafters with **2 - 2" Screws** / Rafter end.

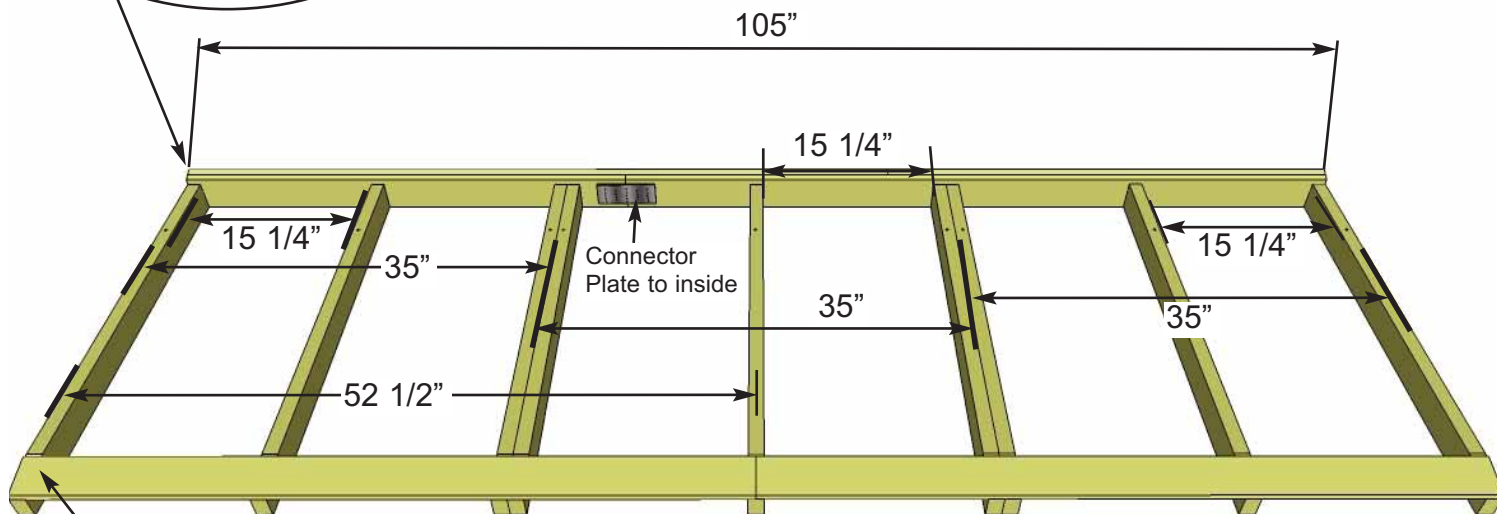

Important: Pilot Hole Soffit to prevent splitting!

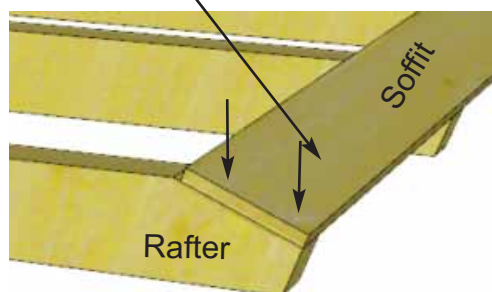

28. Attach end of a Soffit flush to ends of outside rafters with **2 - 1 1/4" Screws** per Rafter end. Drill pilot holes in Soffit to prevent splitting. Complete both outside Rafter / Soffit connections first. Measure and position interior Rafters as illustrated above. When positioned correctly, attach Soffit to remaining Rafters with **2 - 1 1/4" Screws** / Rafter.

Flip completed rafter section over. Complete 2nd Rafter section now as per **Steps 26 - 27** with the following exception - **When attaching Ridge Board to Rafter ends, make sure Metal Ridge Board Connector is positioned so offset to first Rafter Section. See Step 33 for illustration.**

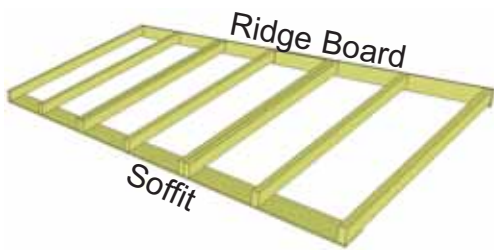

29. Flip Rafter Section over so Soffit is facing down. Starting with the rear Section, lift completed rafters up and place on gable framing.

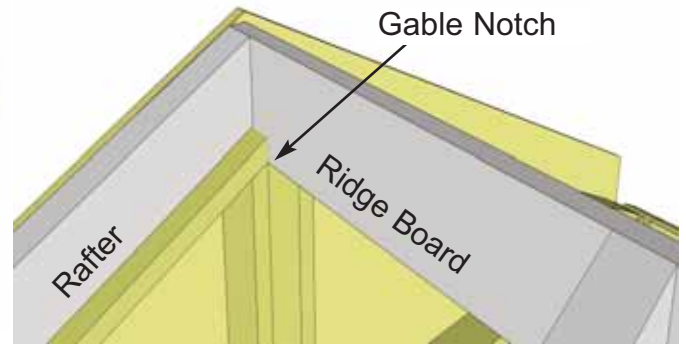
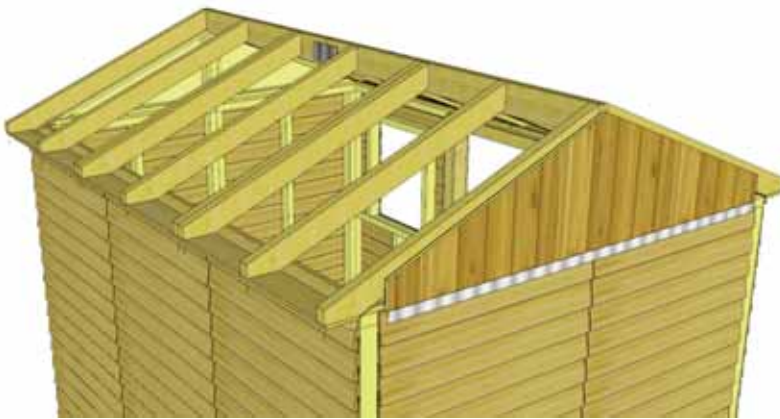
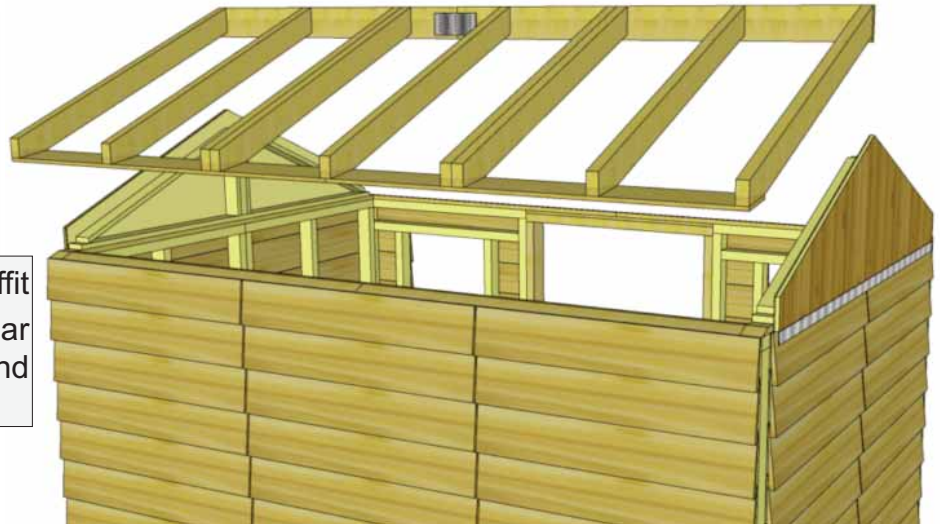

30. Slide Rafter Section up on gable framing until bottom of Ridge Board slips into gable notch.

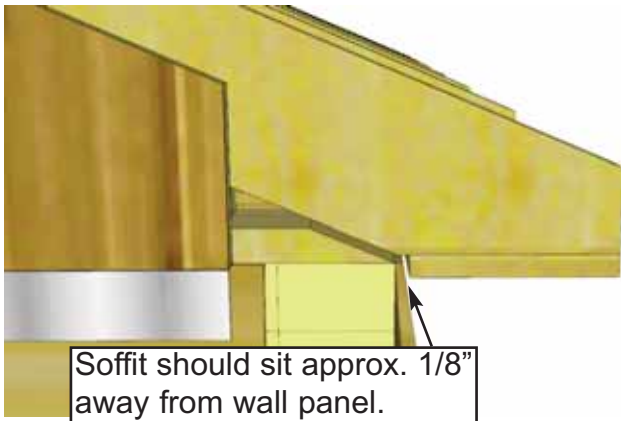

Soffit should sit approx. 1/8" away from wall panel.



31. When Rafter Section is correctly positioned, outside rafters will sit equally on gable framing and Soffit will sit approximately 1/8" away from wall panels.

32. Place front completed Rafter Section on gable walls as per **Steps 30 & 31.**

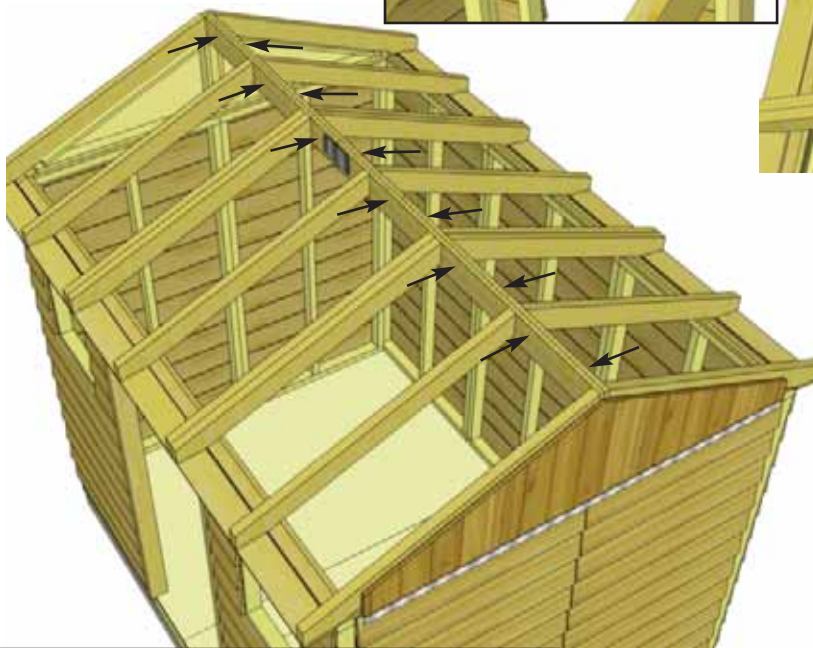
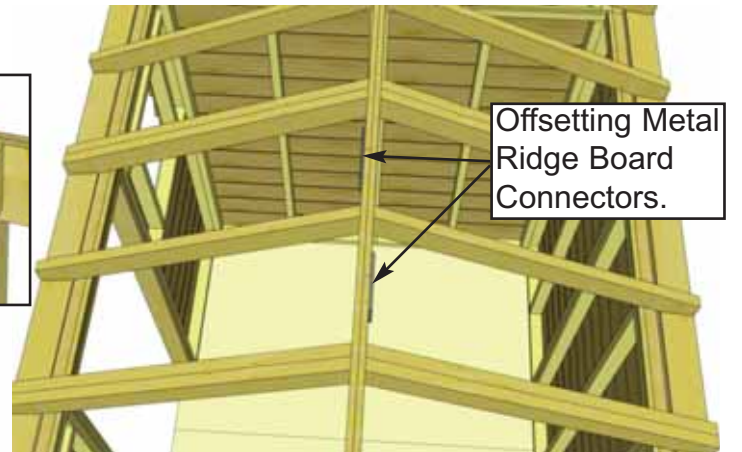
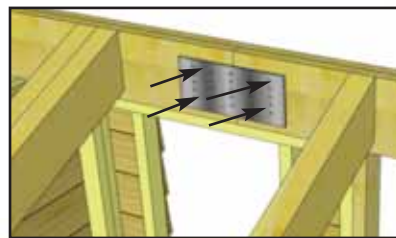
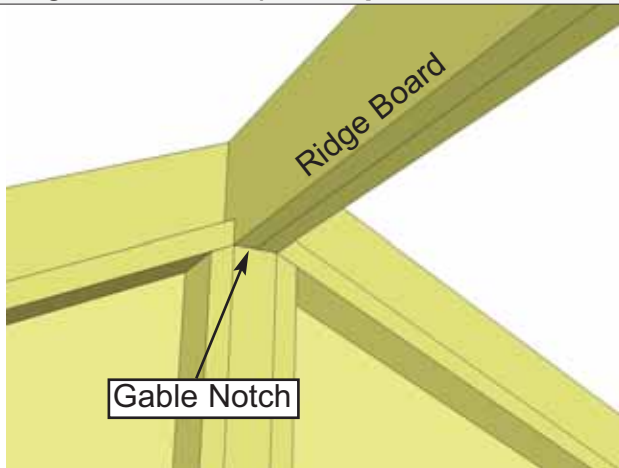

33. At the peak, align Ridge Boards so they are flush together and secure them with **12 - 1 1/4" Screws.**

Important: if there is a gap between Ridge Boards, have a helper push the front and rear walls closer together from outside. Walls should be 70" apart at top from inside of wall plate to opposite wall plate. To completely secure Ridge Boards, place **1 1/4" Screws** into any of the remaining metal Ridge Board Connector holes. Complete both sides.

Hardware

S2 - 1 1/4" Screws x 20 total (approx.)

34. With both Ridge Boards connected, completely secure Gable framing to walls and rafters. Use **4 - 2" Screws** per Rafter. Use an additional **6 - 2" Screws** to secure Gable to wall.

Note: you may have to remove the 2 temporary screws in Gable from Step 23 and reposition Gable for best fit prior to completing gable attachment.

Hardware

S3 - 2" Screws x 28 total

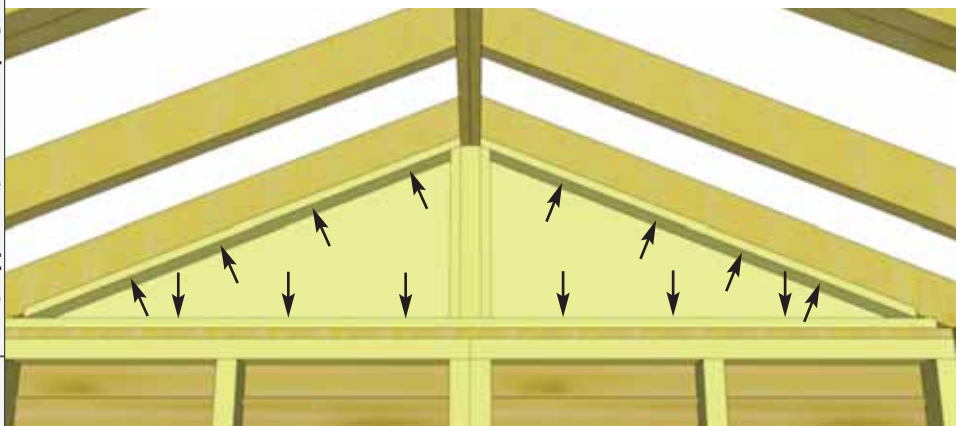

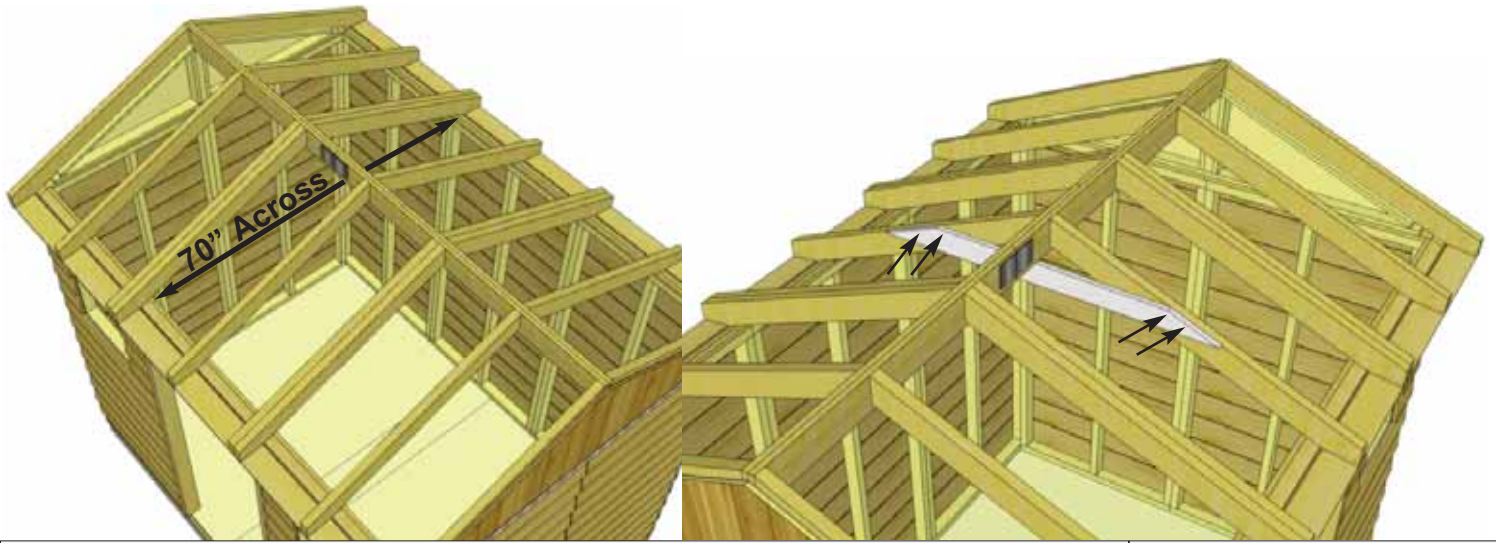

35. Roof Gussets are positioned on mid rafters. Have two helpers push the Front and Rear Walls at the top from the outside of shed until inside to inside measurement between the Top Plates is 70". Slide Gusset up on side of Rafters. Gusset must be below top edge of Rafter. Use level to square Gusset and attach to Rafters with **4 - 2" Screws**. Pilot hole each Gusset end with 1/8" drill bit.

Parts (Steps 35 - 36)

Roof Gussets

(3/4" x 3 1/2" x 48") x 3

Hardware (Steps 35 - 36)

S3 - 2" Screws

x 12 total



36. Complete remaining 2 Gussets as per **Step 35**.

37. Attach all Single and Double Rafter Brackets where rafters meet Top Wall Plates inside of shed. Attach with **2 - 1 1/4" Screws** and **2 - 2" Screws** per **Single Rafter Bracket** and **6 - 2" Screws** per **Double Rafter Bracket**.

Have two helpers hold the Front and Rear Walls at the top from the outside of shed to keep the inside-to-inside measurement between the Top Plates at 70".

Hardware

Y30 - Single Rafter Brackets x 6 total

Y31 - Double Rafter Brackets x 4 total

S2 - 1 1/4" Screws x 12 total

S3 - 2" Screws x 36 total

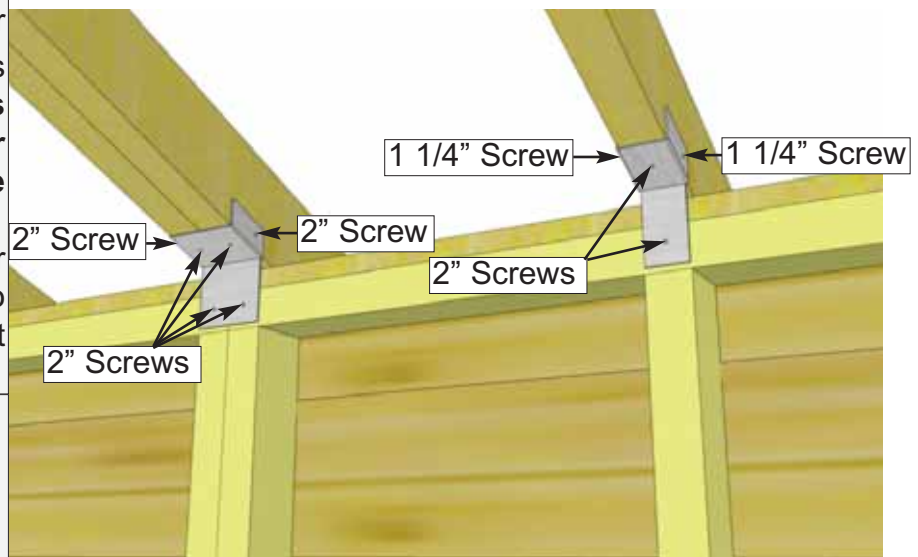

Exploded view of upside down roof panels. Shingles overhang plywood on outside panels.

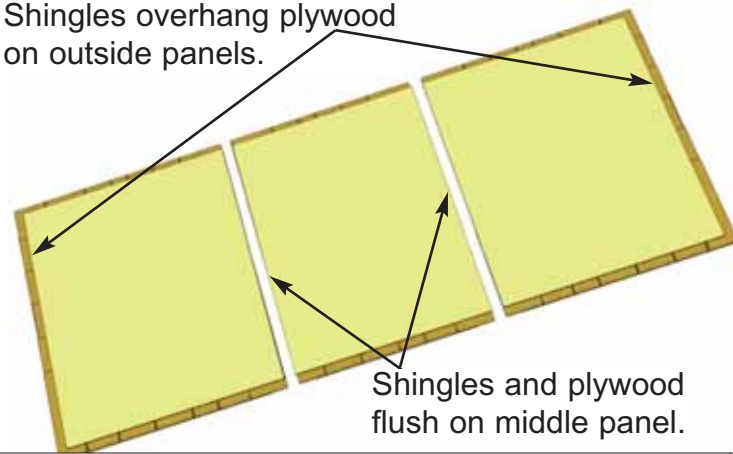

Shingles and plywood flush on middle panel.



38. Identify all Roof Panels. There are 4 Outside and 2 Middle Roof Panels. Outside Panels will have shingles overhanging the plywood on one end. Lift up and place an Outside Roof Panel on Rear Rafters.

Parts (Steps 38 - 42)
Outside Roof Panels
 (41" wide) x 4
Middle Roof Panels
 (35" wide) x 2

Hardware (Steps 38 - 42)
S1 - 2 1/2" Screws
 x 12 total

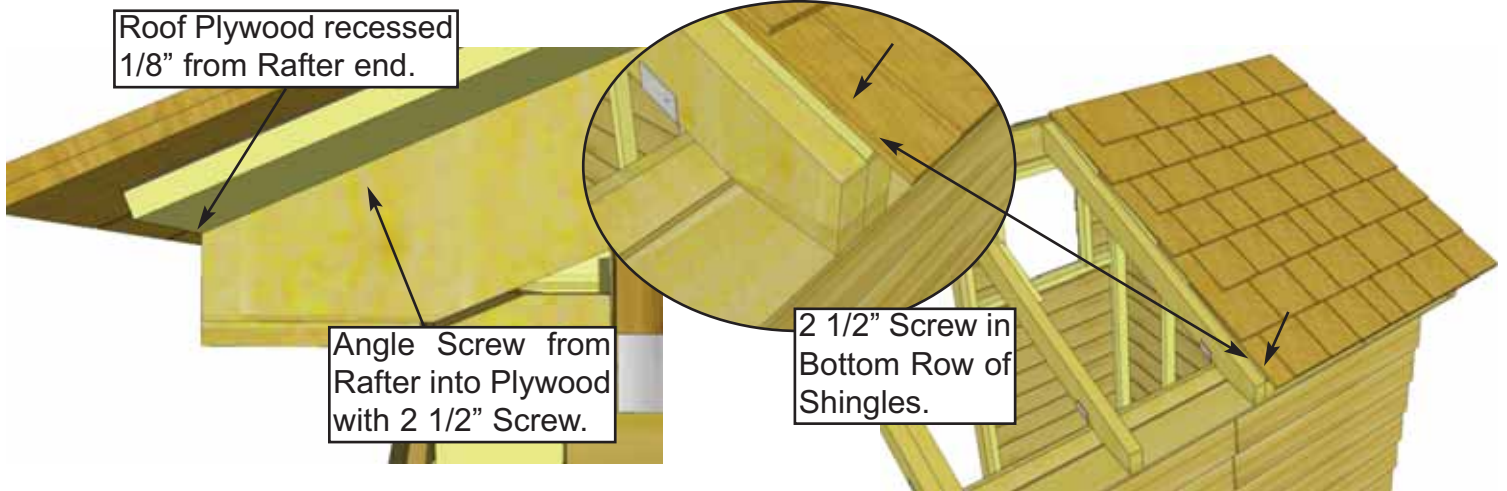

Roof Plywood recessed 1/8" from Rafter end.

Angle Screw from Rafter into Plywood with 2 1/2" Screw.

2 1/2" Screw in Bottom Row of Shingles.

39. Place **Outside Roof Panel** so it sits flush on 3rd Rafter from the outside (doubled up Rafter). Plywood on roof should be flush with end of Rafter at bottom, and with seam of doubled up Rafters. From the outside, screw down through bottom row of shingles into Rafter with **1 - 2 1/2" Screw**. Angle **1 - 2 1/2" Screw** from outside Rafter into roof plywood.

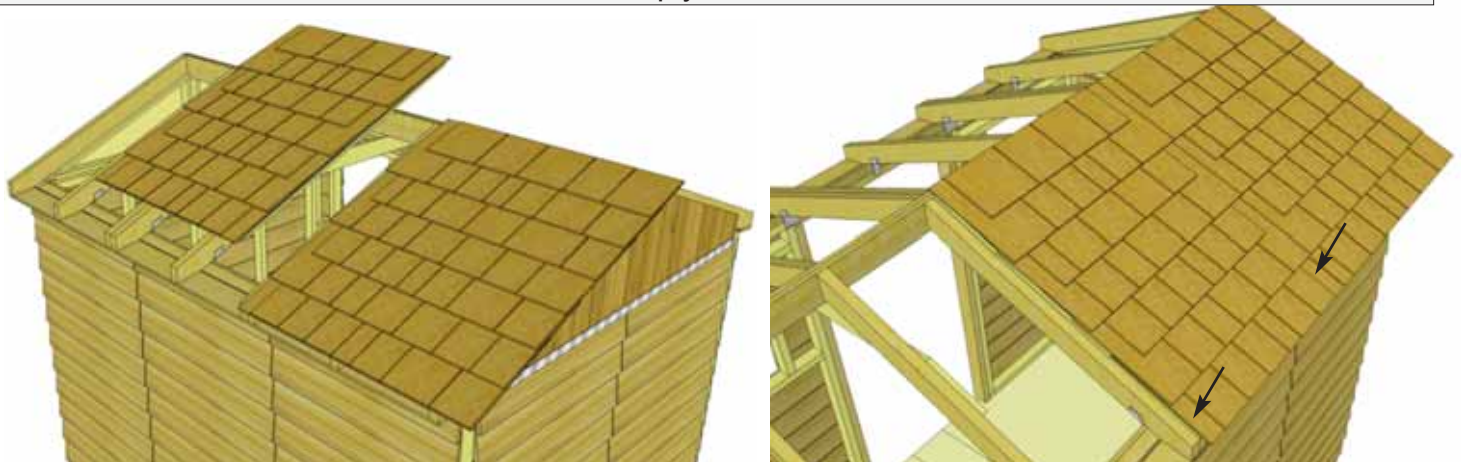

40. Locate a **Middle Roof Panel** (roof plywood flush with outside of shingles), and place on middle Rafters. Align panel as per **Step 39** and screw panel down to Rafters with **2 - 2 1/2" Screws** in the bottom row of shingles.

Shingles overhang plywood on Outside Roof Panel.



41. Lift up, position and attach 2nd **Outside Roof Panel** on Rafters as per **Step 39**.

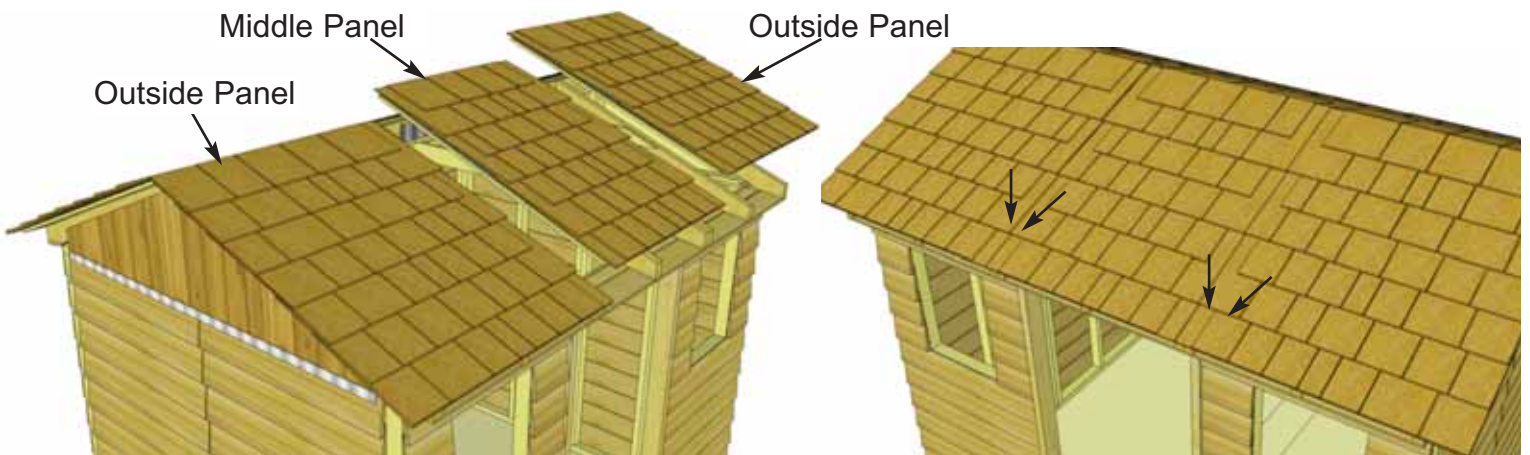

42. Position and attach Front Roof Panels as per **Steps 38 - 41**.



43. Roof **Filler Shingles** are included to cover roof seams. Starting at the bottom, slide the first Long Shingle in until flush with other bottom shingles.

Parts (Steps 43 - 45)

Filler Shingles - Long x 12
Filler Shingles - Short x 4

Hardware (Steps 43 - 45)

S1 - 2 1/2" Screws x 24 total
N2 - 1 1/2" Shingle Nails x 8 total

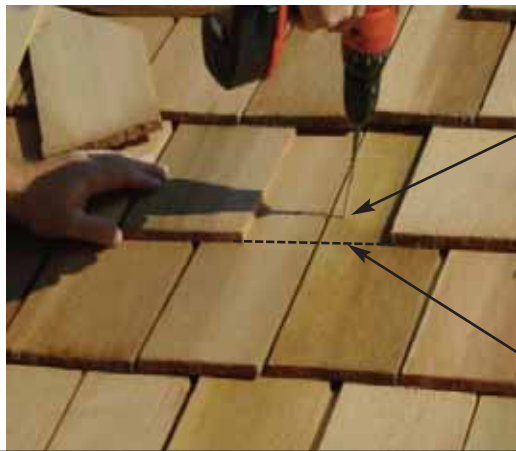

Attach above the exposure line.

Exposure Line

44. Screw first filler shingle down to rafters using **1 - 2 1/2" Screw** per panel (2 in total). Make sure to screw into both rafters.



45. Slide in another filler shingle and attach as per **Step 44**. On your last row of shingles, attach smaller filler shingle with **2 - 1 1/2" Shingle Nails** near the top, to be covered by Ridge Caps in **Step 59**. Complete all four rows of filler shingles where roof seams meet in the same way.

46. Inside the shed, position **2 - 90° Metal Brackets** onto the roof plywood and outside rafter and secure with **4 - 1 1/4" Screws** each. Complete for both Gables - there are 4 Brackets per Gable.

Hardware

Y2 - 90° Metal Bracket x 8 total
S2 - 1 1/4" Screws x 32 total

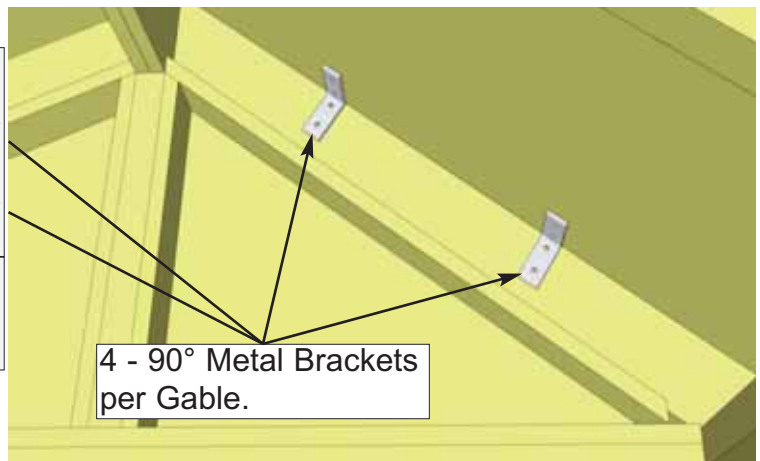

4 - 90° Metal Brackets per Gable.

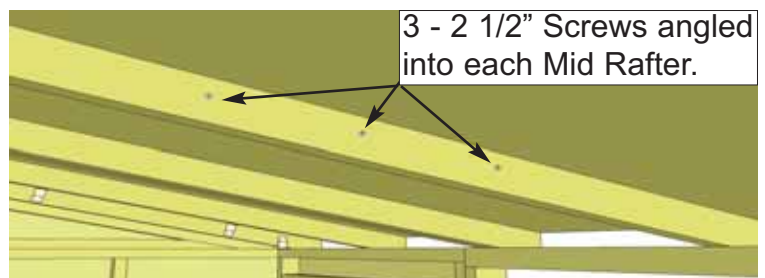
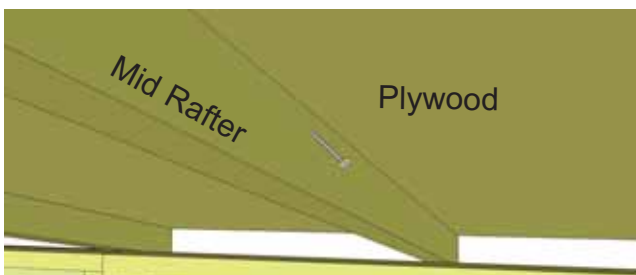

3 - 2 1/2" Screws angled into each Mid Rafter.

47. To further secure roof panels, from the inside, drill pilot holes in each Mid Rafter (3 per Rafter) on an angle. Using **3 - 2 1/2" Screws**, secure rafters to roof plywood. **Note:** from outside, have a helper push roof panel down so plywood sits flush against rafter when securing.

Hardware

S1 - 2 1/2" Screws
 x 18 total

D. Miscellaneous Section

Exploded view of all parts necessary to complete the Miscellaneous Section. Identify all parts prior to starting.

Note: Not shown: Interior Door Stops, 1 Interior Barrel Bolt

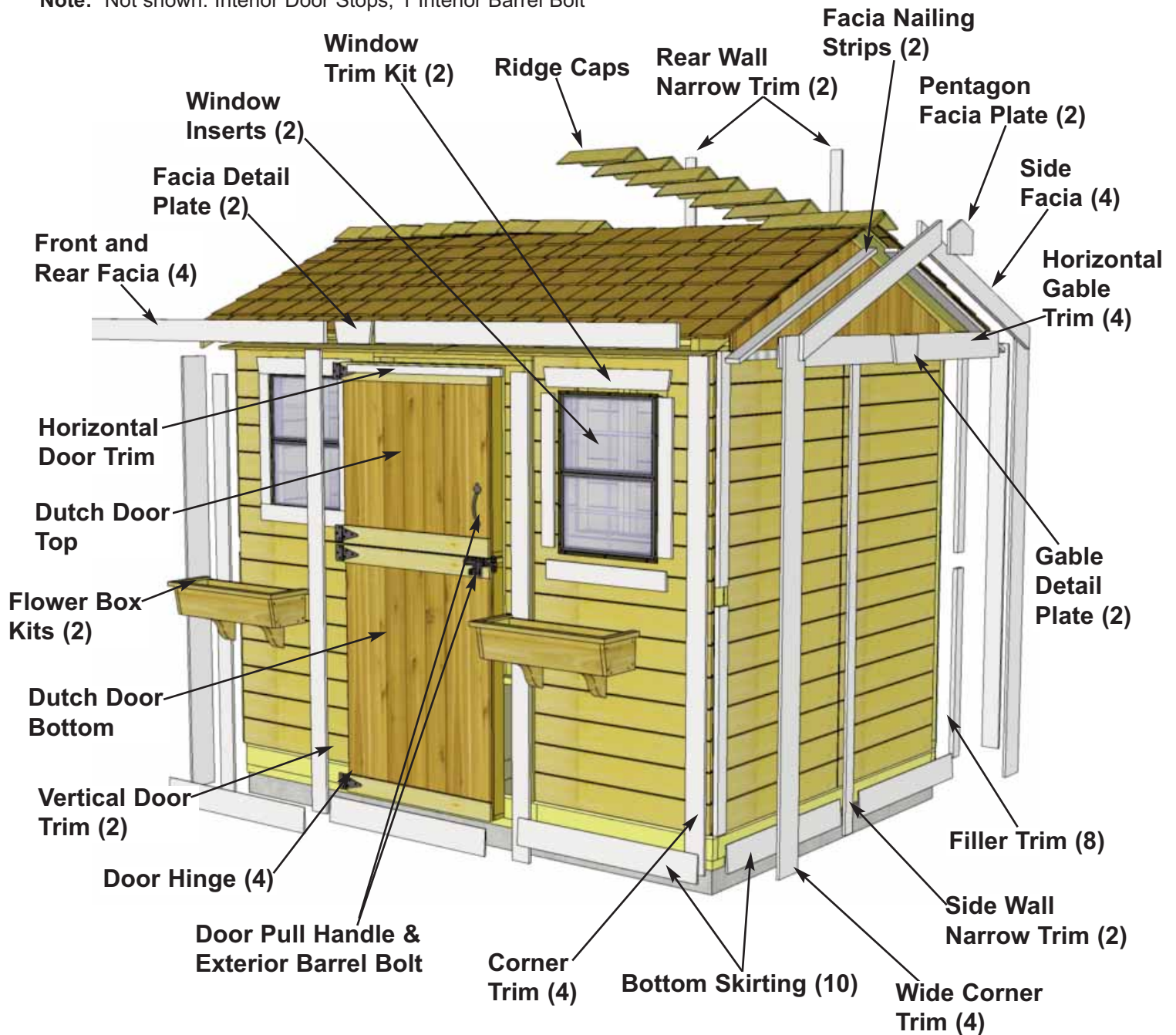

Expert Advice: When installing trim, sort pieces according to color and pieces that are most pleasing to the eye. Start with least visible side of shed and use the least desirable pieces first. Install trim to most visible side of shed as your skill installing trim improves.

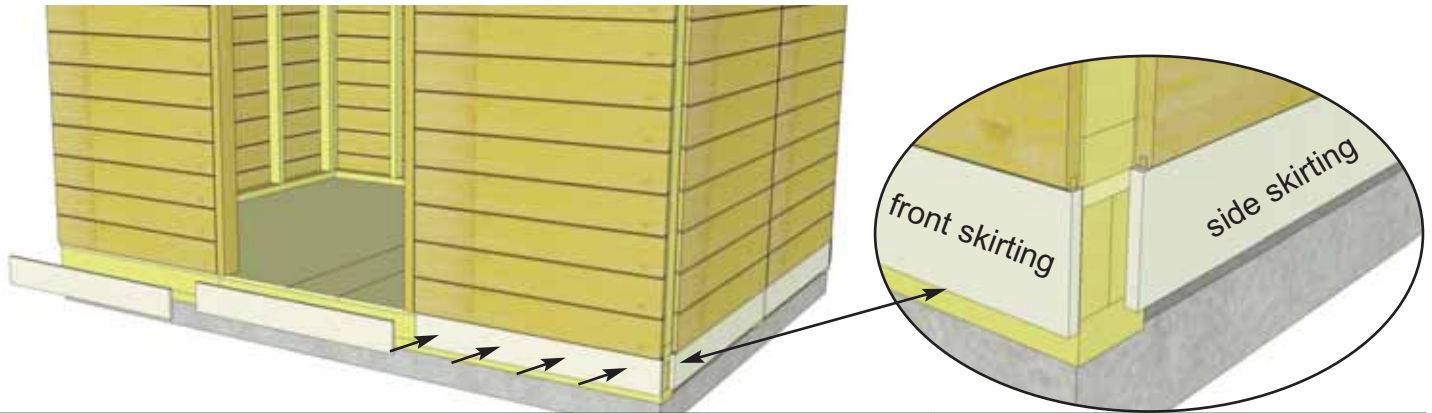

48. Attach **Bottom Skirting** around the base of the shed. Skirting will hide floor framing. Gaps on side will be covered by Wide Trim pieces later. Start with Front and Rear Skirting pieces first and attach with **4 - 1 1/2" Finishing Nails** per piece.

Parts
Bottom Skirting
 (1/2" x 4 1/2" x 34 3/4") x 10

Hardware
N1 - 1 1/2" Finishing Nails
 x 40 total

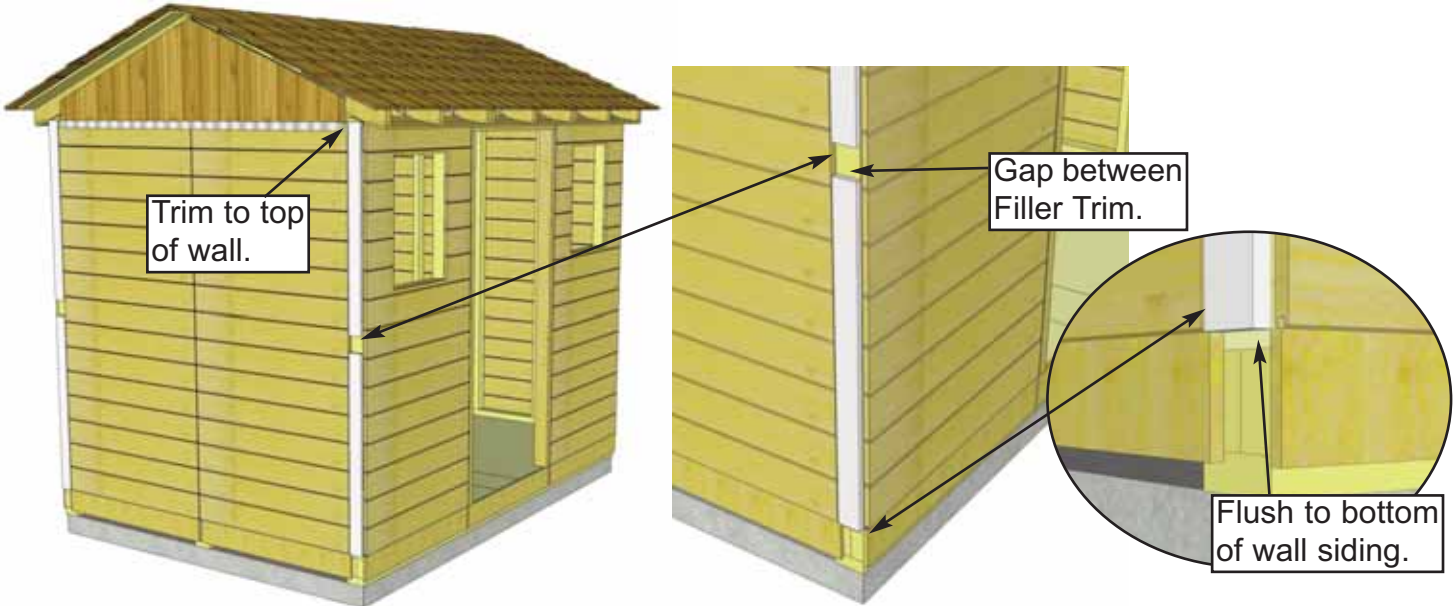

49. Attach **Filler Trim** to each corner side wall (2 per corner). Align Filler Trim so it sits flush with top of Skirting. Attach with **4 - 1 1/2" Finishing Nails** per trim.

Parts
Filler Trim
 (5/8" x 2 1/2" x 36") x 8

Hardware
N1 - 1 1/2" Finishing Nails x 32 total

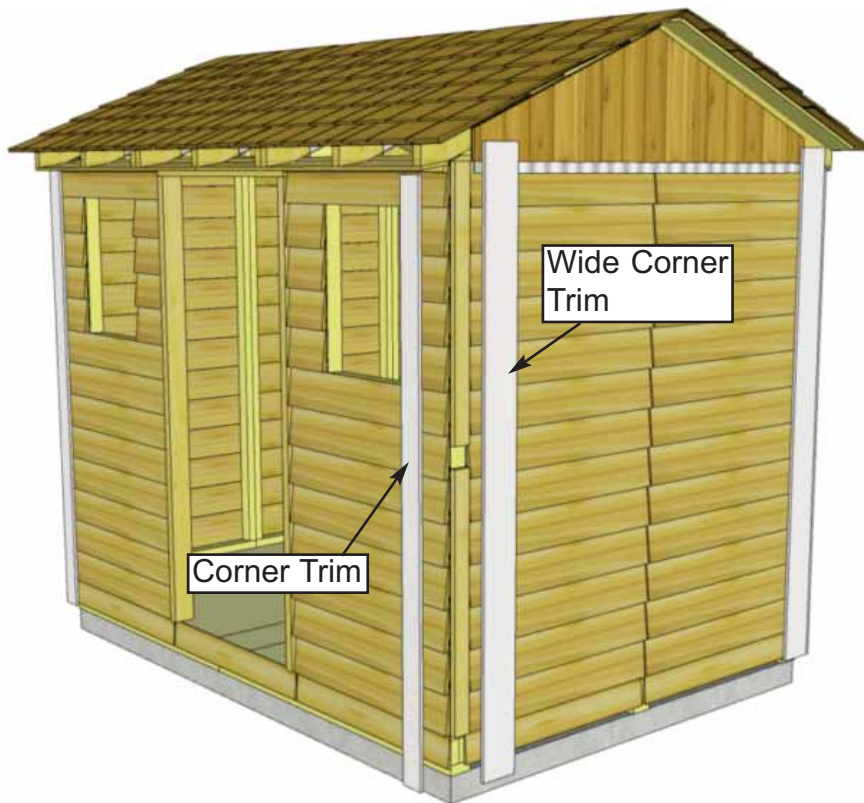

50. To trim out corners, start with a **Corner Trim**, align tight underneath Soffit and Rafter. Align **Wide Corner Trim** with bottom of Corner Trim. Corner Trim will cap the Wide Corner Trim. Do a dry run in each corner before attaching to confirm positioning. Use **8 - 1 1/2" Finishing Nails** per piece to secure. Complete other front corner the same.

Parts (Steps 50 - 51)

Corner Trim
(1/2" x 3 1/2" x 79") x 4

Wide Corner Trim
(1/2" x 5 1/2" x 82") x 4

Hardware (Steps 50 - 51)

N1 - 1 1/2" Finishing Nails
x 64 total

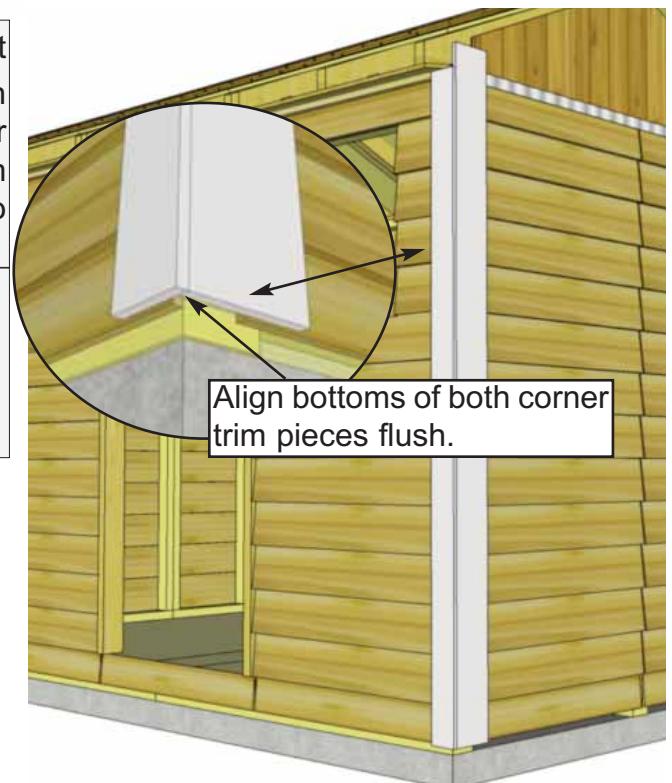

Align bottoms of both corner trim pieces flush.



51. Trim out rear corners with remaining pieces of **Corner Trim** and **Wide Corner Trim**. Align and attach with **8 - 1 1/2" Finishing Nails** per piece as per **Step 50**.

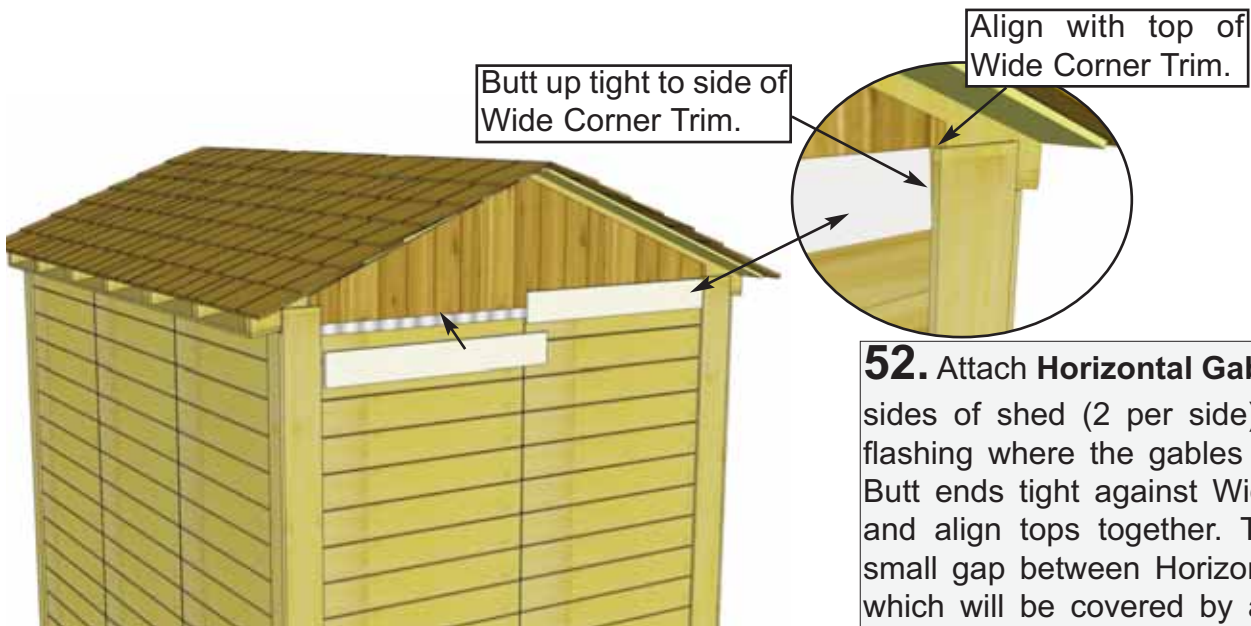

52. Attach **Horizontal Gable Trims** to both sides of shed (2 per side). Position over flashing where the gables and walls meet. Butt ends tight against Wide Corner Trims and align tops together. There may be a small gap between Horizontal Gable Trims which will be covered by a Detail Plate in **Step 58**. Attach with **4 - 1 1/2" Finishing Nails** per piece.



<u>Parts</u>
Horizontal Gable Trims (1/2" x 4 1/2" x 32 3/4") x 4
<u>Hardware</u>
N1 - 1 1/2" Finishing Nails x 16 total



53. Attach **Rear Wall Narrow Trim** where wall panels come together and leave a seam. Position trim equally on wall seam and tight underneath Soffit and Rafter. Use **8 - 1 1/2" Finishing Nails** per piece to secure.

<p><u>Parts</u> Rear Wall Narrow Trim (1/2" x 2 1/2" x 79") x 2</p>
<p><u>Hardware</u> N1 - 1 1/2" Finishing Nails x 16 total</p>

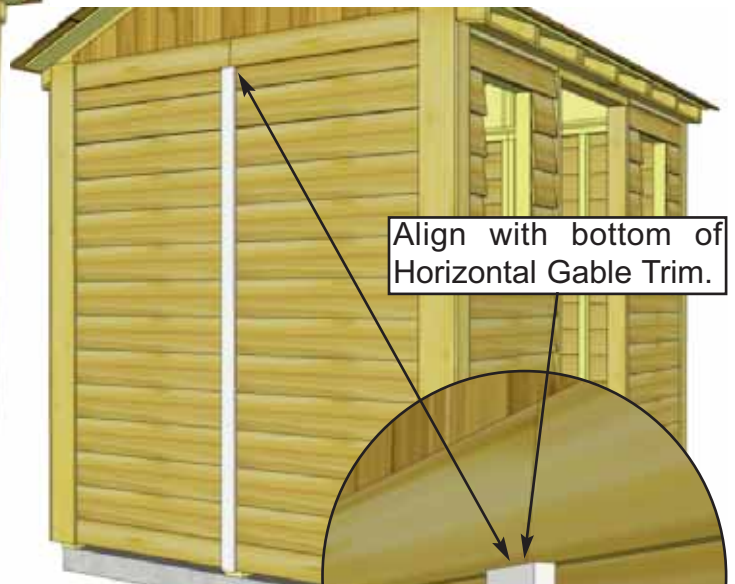
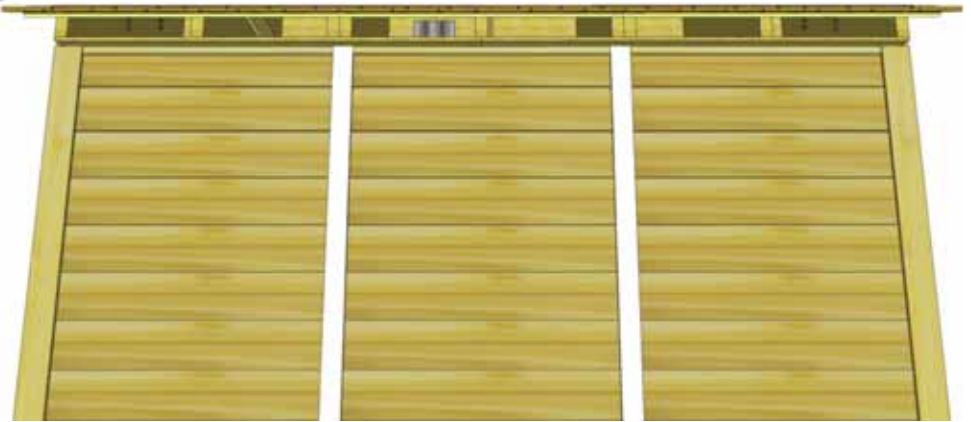

Align with bottom of Horizontal Gable Trim.

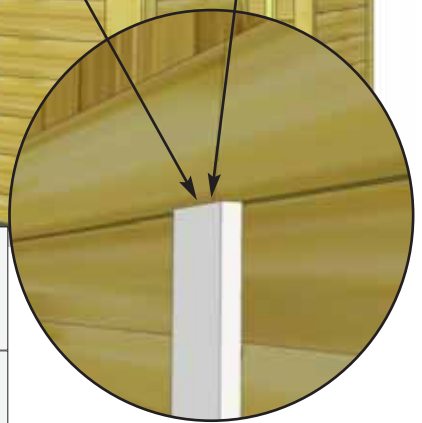

54. Attach both **Side Wall Narrow Trims** where wall seams come together on sides. Position trim equally on wall seam and flush with the bottom of the Horizontal Gable Trim. Use **8 - 1 1/2" Finishing Nails** per piece to secure.

<p><u>Parts</u> Side Wall Narrow Trim (1/2" x 2 1/2" x 77 1/4") x 2</p>
<p><u>Hardware</u> N1 - 1 1/2" Finishing Nails x 16 total</p>



55. Attach **Facia Nailing Strips** to the underside edge of the plywood roof. Align corner of Nailing Strip with corner of roof plywood. Secure each Strip with **3 - 1 1/4" Screws**. Complete all four pieces, two on each side of the shed.

Parts

Facia Nailing Strips

(3/4" x 2 1/2" x 44 1/2") x 4

Hardware

S2 - 1 1/4" Screws x 12 total

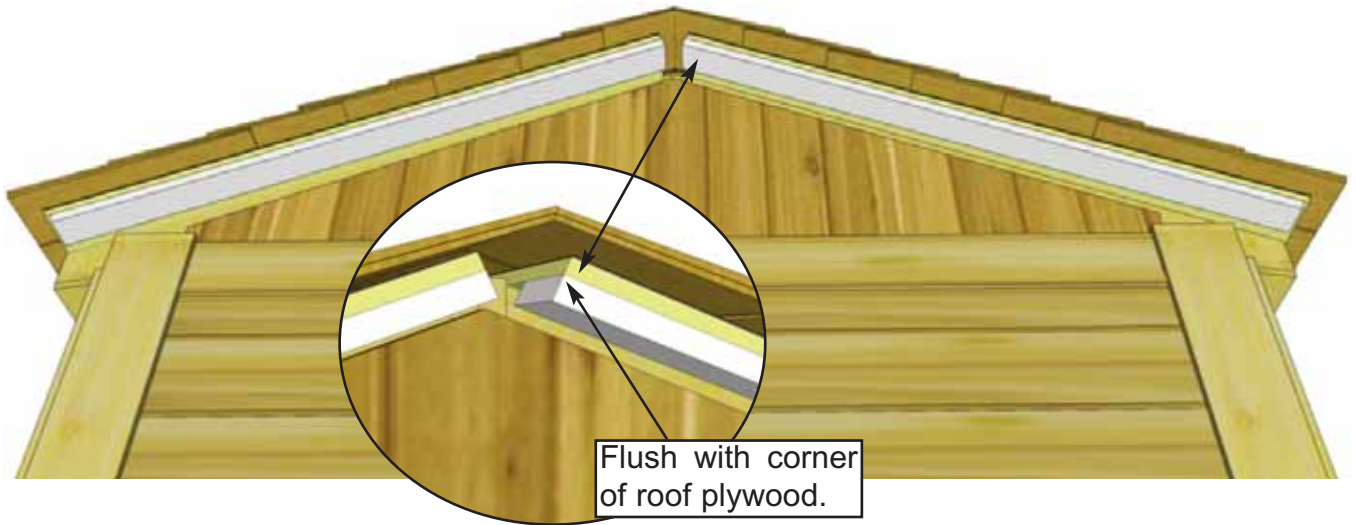

56. Attach **Side Facia** to end of roof panel plywood and Nailing Strip. Line Facia up to form a peak and attach to Nailing Strip/plywood with **6 - 1 1/2" Finishing Nails** per piece. End of Facia should be aligned flush with end of Rafter. See **Step 57** for detail. Gap where Facia boards come together at peak will be covered in **Step 58**.

Parts

Side Facia - Angle Cut Ends

(3/4" x 3 1/2" x 45 7/8") x 4

Hardware

N1 - 1 1/2" Finishing Nails

x 24 total

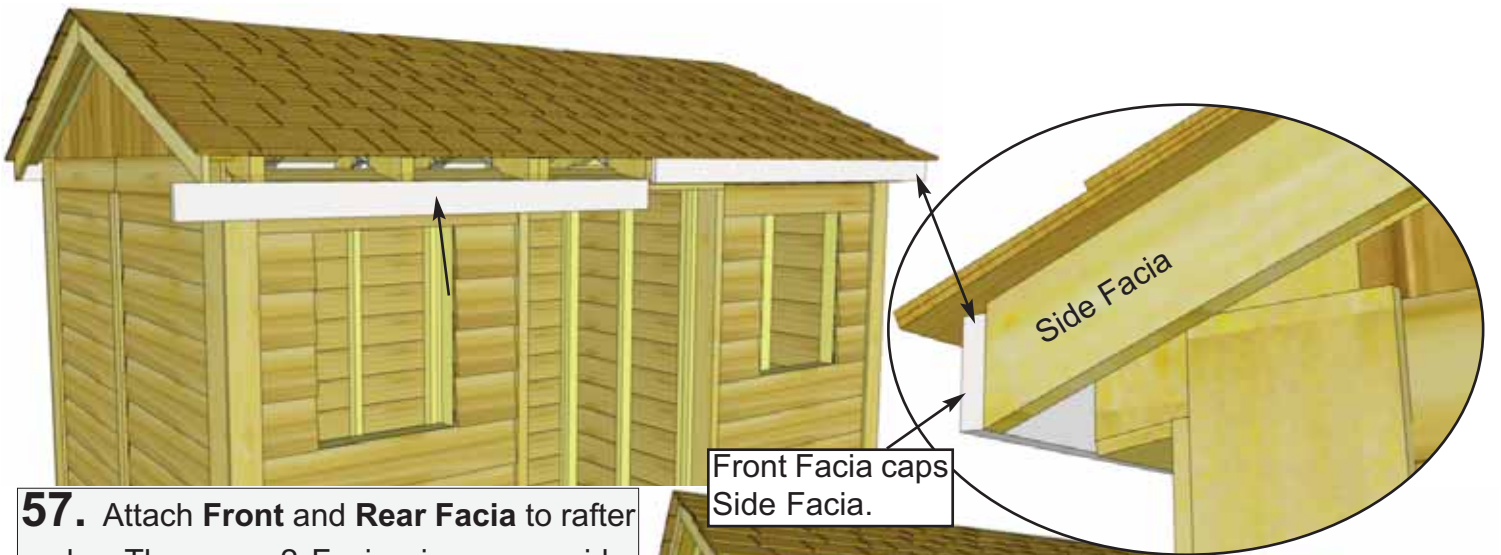

57. Attach **Front and Rear Facia** to rafter ends. There are 2 Facia pieces per side. Secure with **8 - 1 1/2" Finishing Nails** per piece, ensure nails connect with the ends of the rafters behind Facia. Gaps between facia pieces will be covered by Detail Plates in **Step 58**.

<p><u>Parts</u> Front & Rear Facia (3/4" x 3 1/2" x 57 1/4") x 4</p>
<p><u>Hardware</u> N1 - 1 1/2" Finishing Nails x 32 total</p>

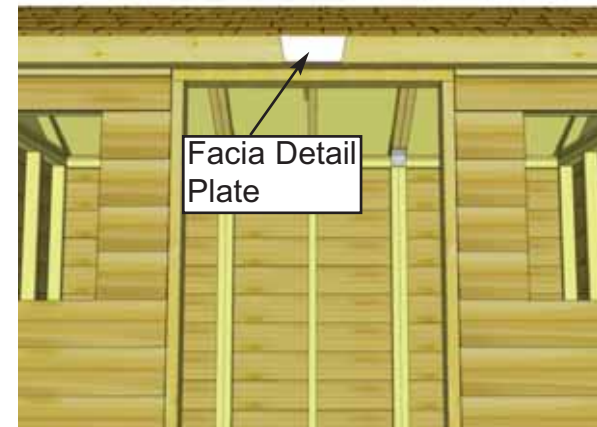
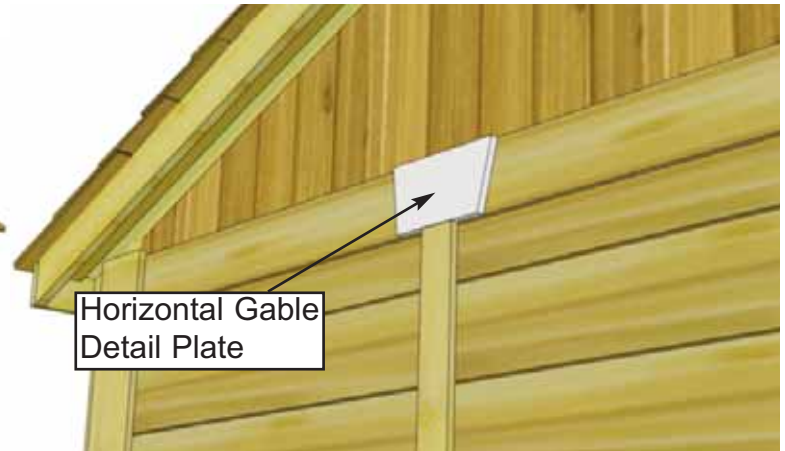

58. Attach **Pentagon Facia Plates** where Side Facias meet at the peak. Secure with **4 - 1 1/2" Finishing Nails** per piece. Attach **Facia Detail Plates** to cover seams where Front and Rear Facia pieces meet. Secure with **4 - 1 1/2" Finishing Nails** per piece. Attach **Horizontal Gable Detail Plates** to cover seams where Horizontal Gable Trims meet. Secure with **4 - 1 1/2" Finishing Nails** per piece.

<p><u>Parts</u> Pentagon Facia Plates (1/2" x 5 1/2" x 8") x 2 Facia Detail Plates (1/2" x 3 1/2" x 8") x 2 Horizontal Gable Plates (1/2" x 4 1/2" x 8") x 2</p>	<p><u>Hardware</u> N1 - 1 1/2" Finishing Nails x 24 total</p>
---	--

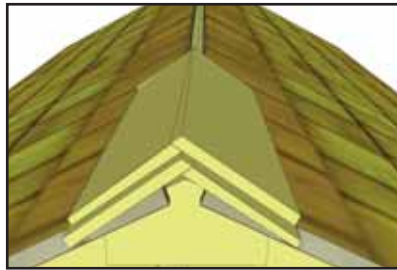
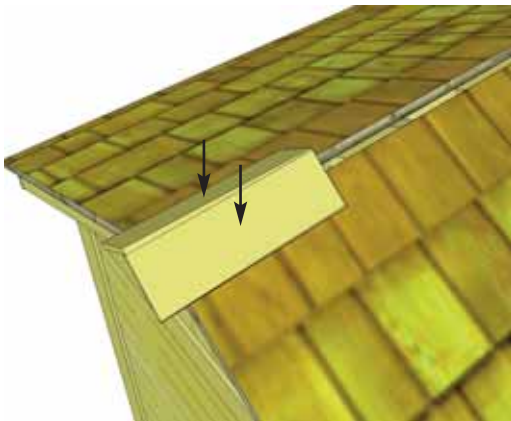

Important: Butt (thick) end of Ridge Cap will be facing towards the outside of shed.

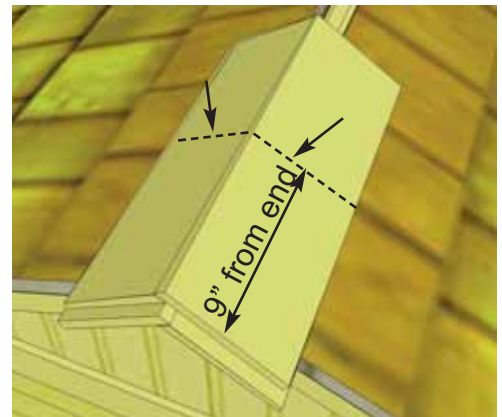

59. Place 1st **Roof Ridge Cap** on roof peak overhanging shingles by approximately 1". Attach with **2 - 1 1/2" Shingle Nails** 9" from end. Place 2nd Ridge Cap 1" back from 1st cap. Attach with **2 - 1 1/2" Shingle Nails** 9" from end.

Parts (Steps 59 - 60)

Roof Ridge Caps x 18

Hardware (Steps 59 - 60)

N2 - 1 1/2" Shingle Nails x 38 total

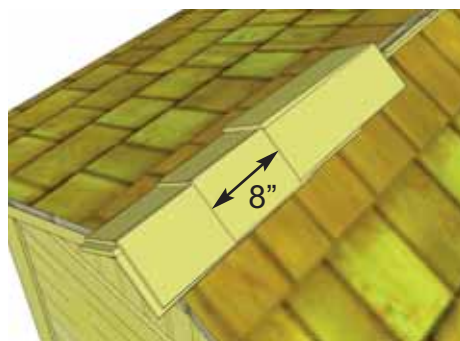
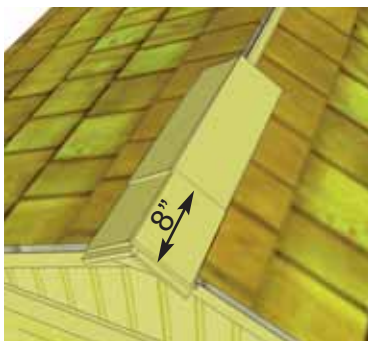

60. Place 3rd Ridge Cap 8" back from 2nd (enough to cover shingle nails). Attach 3rd Ridge Cap as per **Step 59**. Continue to position and attach Ridge Caps until half the roof is complete. From opposite side, position and attach Ridge Caps as described above. Score/cut 1 Ridge Cap to 12" or to fit in the center of roof. Attach center cap with **4 - 1 1/2" Shingle Nails**.

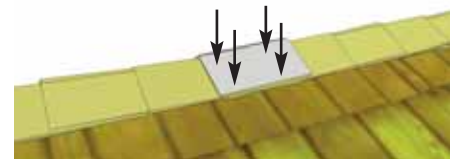



61. Position **Vertical Door Trim** pieces flush with inside edge of Door Jambs and tight to Soffits on top. Attach with **8 - 1 1/2" Finishing Nails** per piece.

<u>Parts</u>	<u>Hardware</u>
Vertical Door Trim (1/2" x 3 1/2" x 79") x 2	N1 - 1 1/2" Finishing Nails x 16 total



62. Attach **Horizontal Door Trim** with **4 - 1 1/2" Finishing Nails** to cover Door Header.

<u>Parts</u>
Horizontal Door Trim (1/2" x 1 1/4" x 32") x 1
<u>Hardware</u>
N1 - 1 1/2" Finishing Nails x 4 total



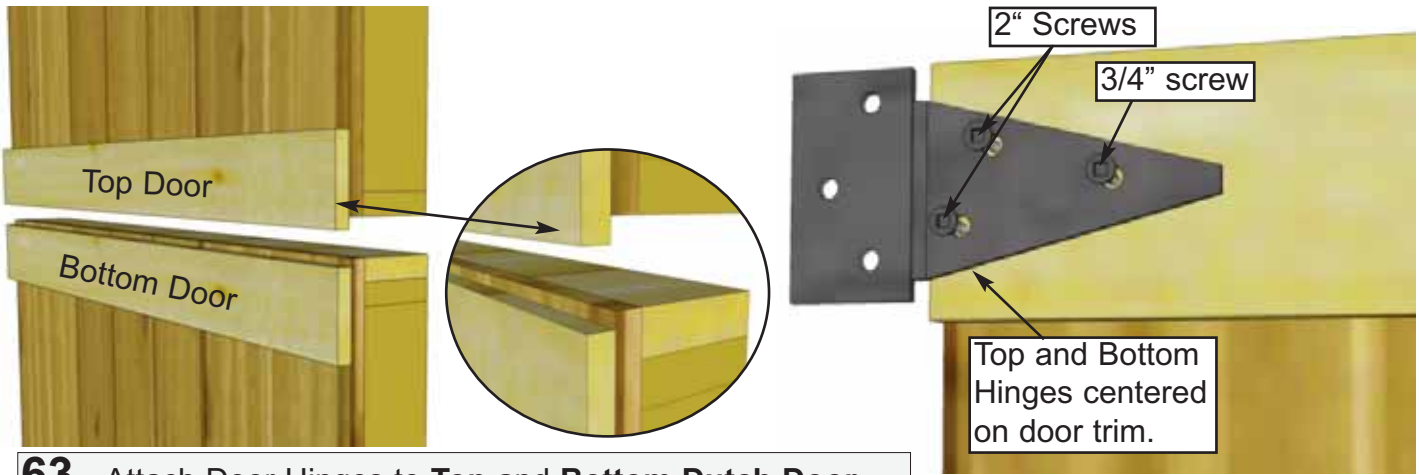

63. Attach Door Hinges to **Top** and **Bottom Dutch Door** sections. Top Door has trim overhanging door at bottom while bottom door has trim recessed slightly. Hinges should be centered on door trim with barrel nudged to end of trim. Use **2" & 3/4" Black Headed Screws** as shown above.

Parts (Steps 63 - 65)

Dutch Door - Top
(31 1/2" x 30") x 1
Dutch Door - Bottom
(31 1/2" x 42") x 1

Hardware (Steps 63 - 65)

Y1 - Tee Hinges
x 4 total
SB1 - 3/4" Black Screws
x 4 total
SB2 - 2" Black Screws
x 20 total

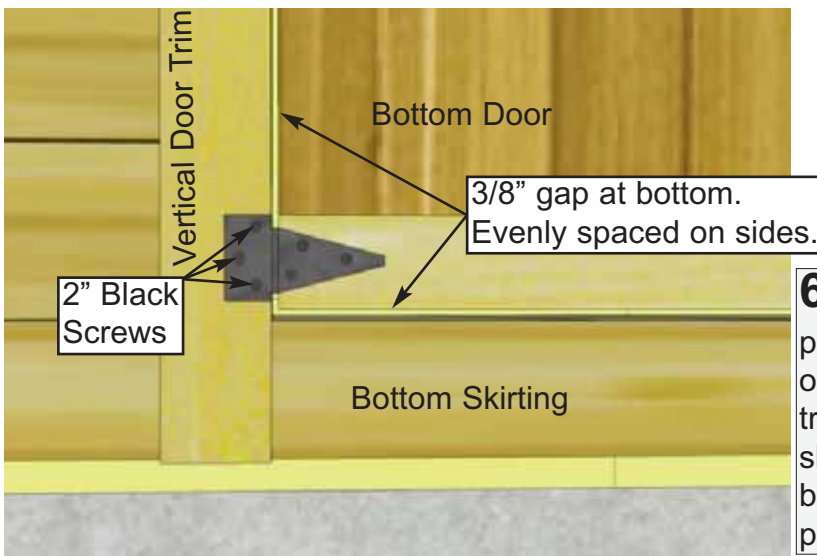
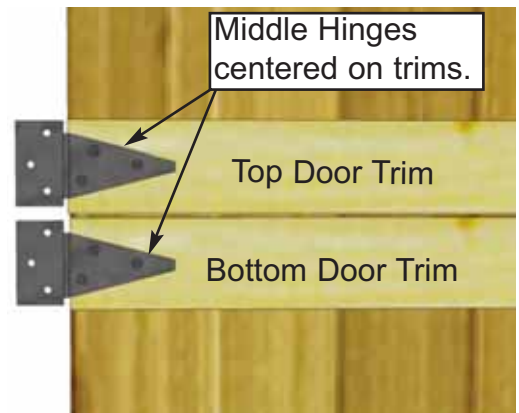

64. Place Bottom Dutch Door panel into position. Gap 3/8" on bottom, evenly space on sides, and attach hinge to doorway seam trim with **2" Black Headed Screws**. Use shim to help keep the door evenly spaced on bottom. One of the extra roof shingles (see parts list) can be used.

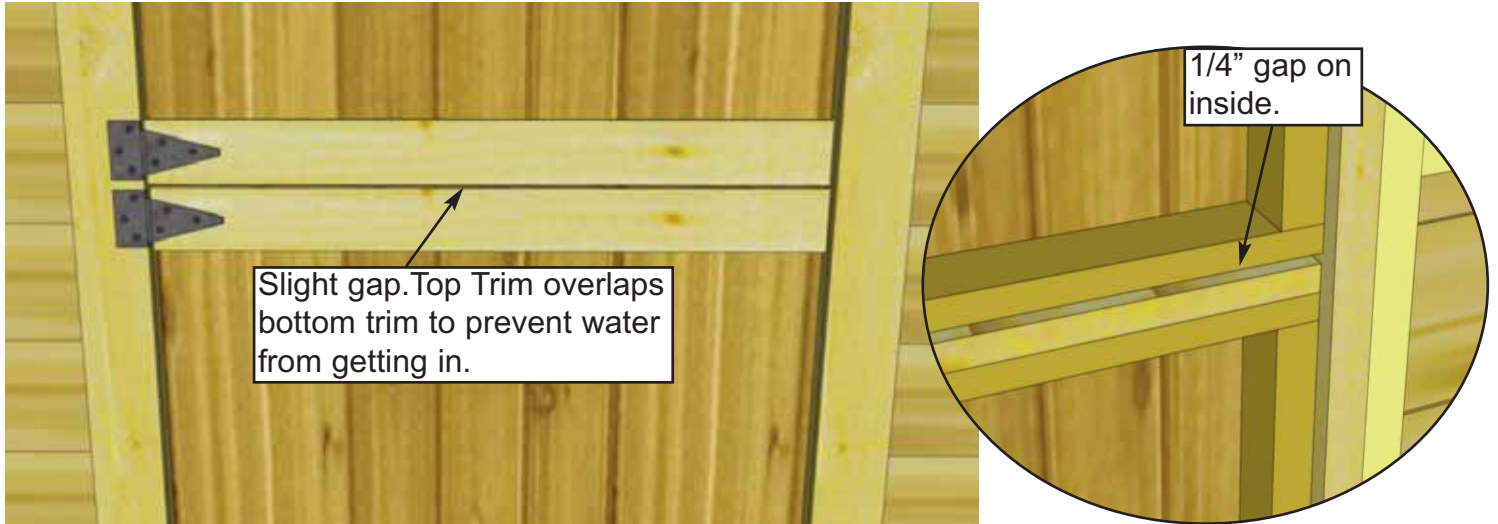

65. Place the Top Dutch Door Panel into place and gap top and bottom trims on the outside about 1/8" apart. On the inside, horizontal door frames should be about 1/4" apart. Use a shim once again to help you. Attach hinges to trim with **2" Black Headed Screws** provided.

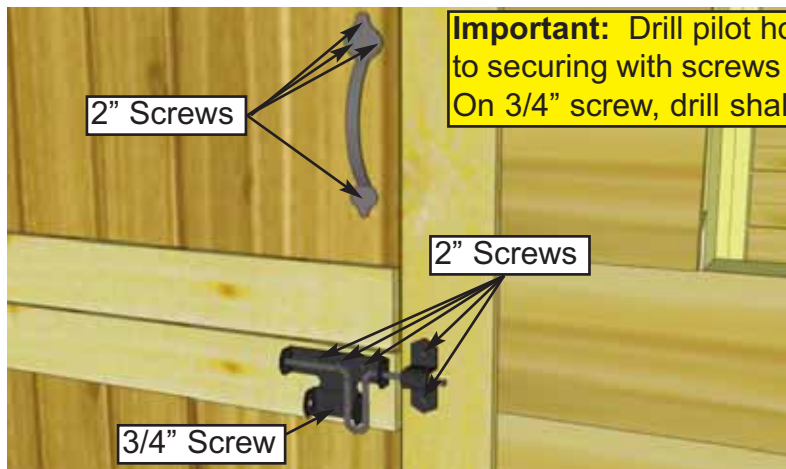

Important: Drill pilot holes with 1/8" drill bit prior to securing with screws to prevent wood splitting. On 3/4" screw, drill shallow pilot hole only.

66. Attach **Door Handle** and **Exterior Black Drop Latch** to door. Handle is positioned on top door, Drop Latch on bottom door. Attach Black Drop Latch as illustrated above with **2" & 3/4" Black Screws**. Note how female part of Drop Latch is positioned higher than male. Do a dry run first to position Drop Latch correctly. Attach Handle with 2" Screws, ensure screws connect with inner door stud.

Hardware	
Y3 - Door Handle	x 1 total
Y4 - Drop Latch	x 1 total
SB1 - 3/4" Black Screws	x 1 total
SB2 - 2" Black Screws	x 9 total

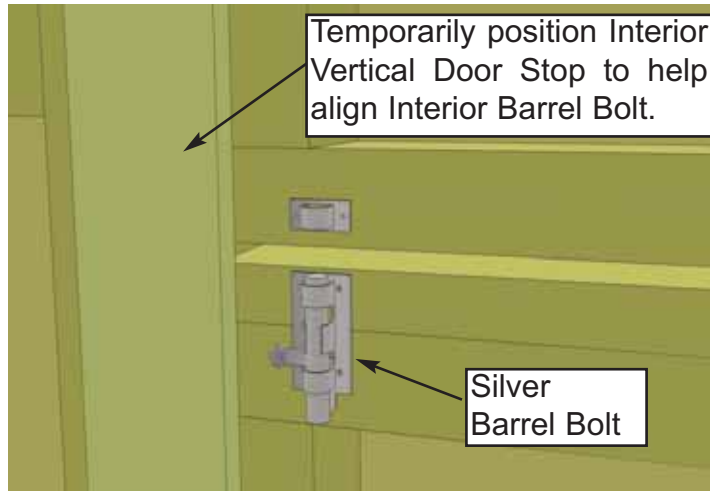

67. Attach Interior **Silver Barrel Bolt** to inside of door as illustrated above. Use **3/4" Silver Screws** to secure. Refer to **Step 68** to allow for adequate clearance.

Hardware	
Y5 - Silver Barrel Bolt	x 1 total
SS2 - 3/4" Silver Screws	x 6 total



68. Attach Interior Door Stops to door framing (Jambs and Header). Start with **Vertical Door Stops**. Stops should overlap doorway by 1/2". Use **4 - 1 1/4" Screws** to secure each piece. Attach **Horizontal Door Stop** next using **3 - 1 1/4" Screws**.

Parts
Vertical Door Stops (1/2" x 2 1/2" x 72") x 2
Horizontal Door Stop (1/2" x 2 1/2" x 36") x 1

Hardware
S2 - 1 1/4" Screws x 11 total

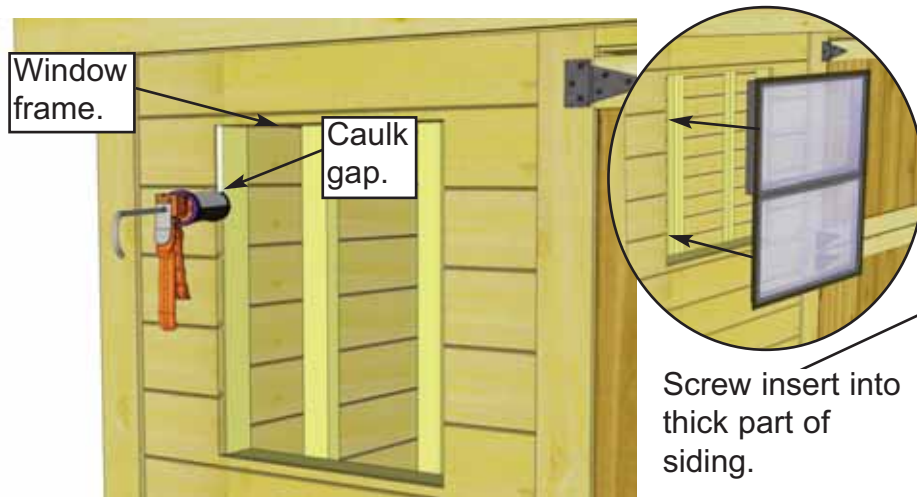

69. To reduce possible water from penetrating into the window cavity, caulk gap on both sides of window opening prior to installing **Window Insert**. Position insert in cavity and screw with **6 - 1 1/4" Screws**.

<u>Parts</u> Window Inserts x 2
<u>Hardware</u> S2 - 1 1/4" Screws x 12 total

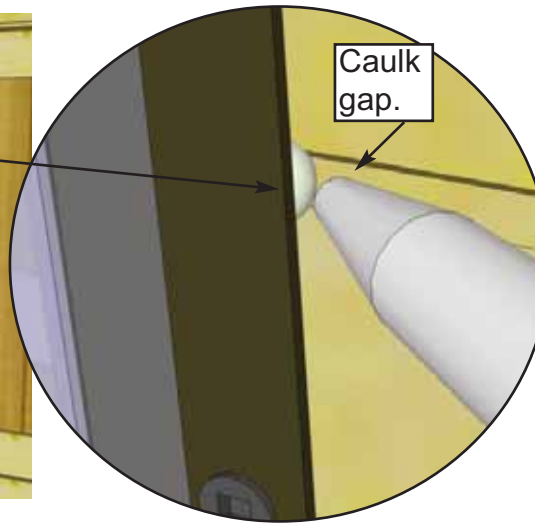

70. Once Insert is attached, caulk the "channel gap" between the Insert's outside flange and the siding. Also put a bead of caulking horizontally at top of window where the flange and siding meet. This additional caulking will also will reduce the chances of moisture entering into your shed.

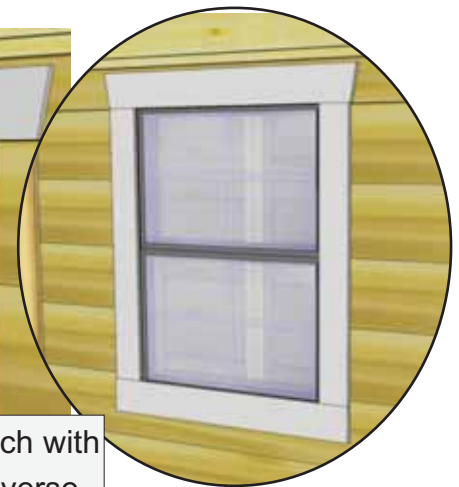
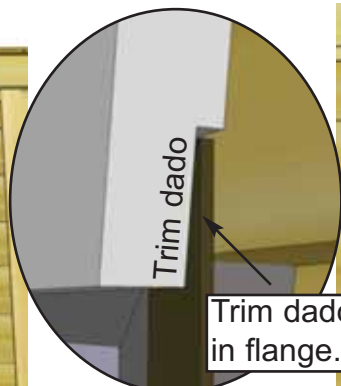

71. Position **Window Trim** around window doing a dry run first and attach with **4 - 1 1/2" Finishing Nails** per piece. Window trim has a small dado on reverse face. Outside flange of window will roughly sit in the dado to give a better fit.

<u>Parts</u> Window Trim Package x 2 (Top - 24 1/16" Long - <i>Angle Cut Ends</i>) x 1 (Sides & Bottom - 23" Long) x 3	<u>Hardware</u> N1 - 1 1/2" Finishing Nails x 32 total
---	---



72. Assemble **Flower Box** with Assembly Instructions included on Page 40. Position completed Flower Box below bottom of window trim and secure with **2 - 2” Screws** per box. Screw from inside of box into the center wall stud. Attach second screw 2” underneath first screw and once again into the wall stud. Install Flower Box Kits underneath each window.

<u>Parts</u>	<u>Hardware</u>
Flower Box Kits x 2	S3 - 2” Screws x 4 total



Alternate Door Configuration (Door on Left or Right of Center)

To configure the Cabana so the Door is positioned on the left or right of center wall panel, follow the general directions in this manual for a regular door configuration and note the following changes.

A. Follow sequential **Steps 9 - 17** in the Wall Section for regular configuration to position and secure wall panels. For Door on left side, align and attach two Window Wall Panels in center and right positions. For Door on right side, configure Window Walls on opposite side.

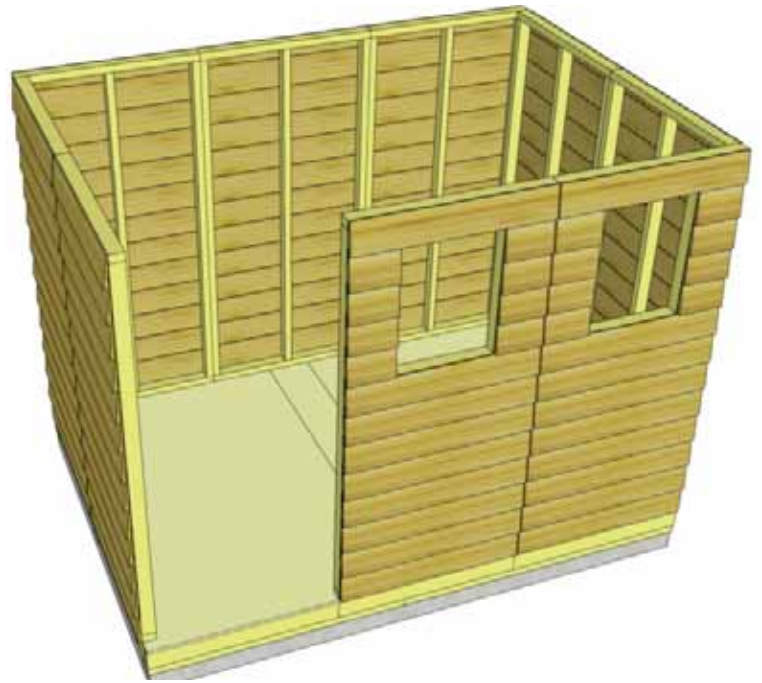

B. With walls positioned and attached together, locate Door Jamb and orientate on Side Wall Panel stud. Align Door Jamb so Flush with bottom wall plate of wall framing. Wall siding will overhang 1/2" on outside. Door Jamb will overhang the floor on the doorway side by 1".



C. When correctly aligned, attach Door Jamb to wall stud with **4 - 2 1/2" Screws**.

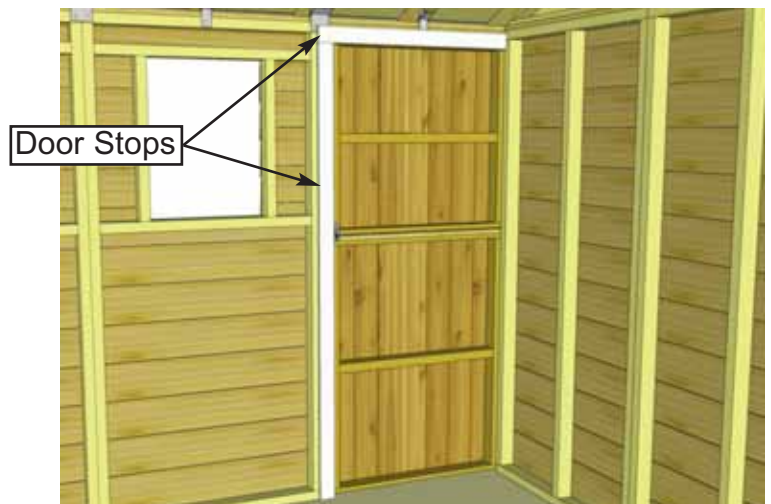

D. Attach 1 Vertical and Horizontal Door Stop. See **Step 69** for detail. You may have to trim Horizontal Door Stop to fit.

Outdoor Living Today Flower Box Assembly Instructions

Parts Lists:

A - Base, Rear & Front Box Frames	(3pcs)	3/4" x 5 1/2" x 23"
B - End Cap Frames	(2pcs)	3/4" x 5 1/2" x 7" / 8"
C - Front Trim	(1 pc)	3/4" x 1 1/2" x 26"
D - Side Trims	(2 pc)	3/4" x 1 1/2" x 8 3/4"
E - Brackets	(2 pc)	1 1/2" x 5 1/2" x 5 1/2"
F - 1 1/4" Screws		
G - 1 1/4" Nails		

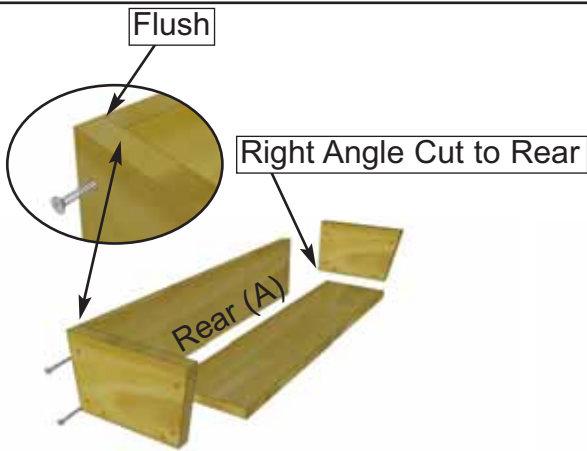
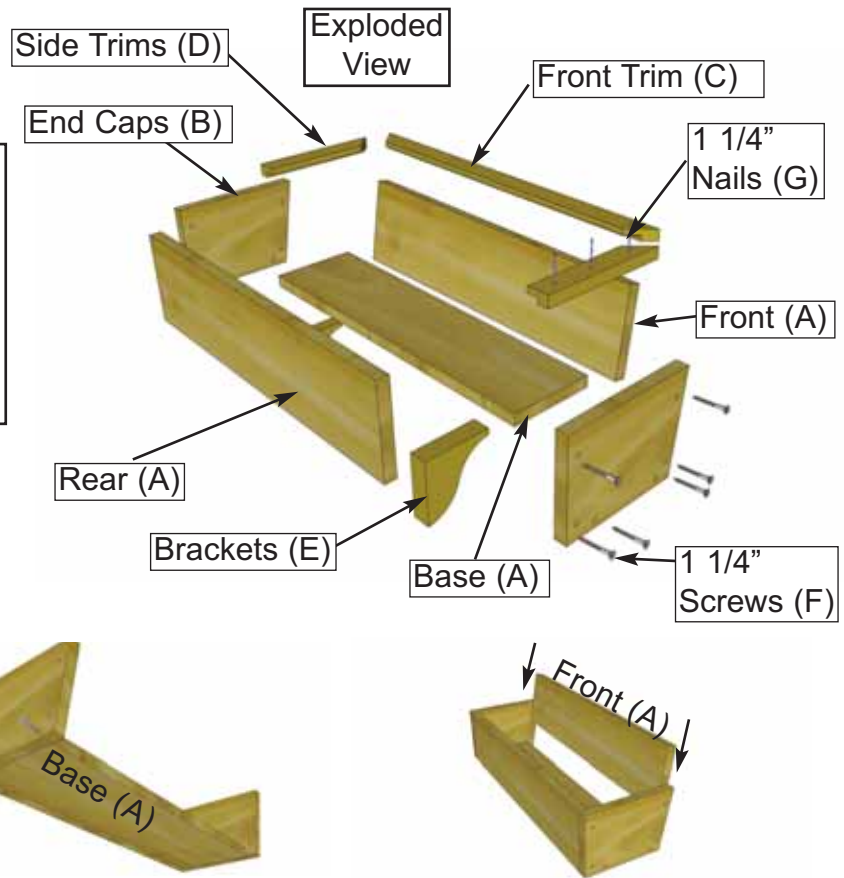

1. On a table position Rear Box and End Cap Frames together so flush at top. Fasten together with 2 - 1 1/4" screws. Place Base Frame tight against Rear and End Cap and flush at bottom. Secure with 2 - 1 1/4" screws. Complete attachment of remaining End Cap Frame. Slide Front Frame between End Caps.

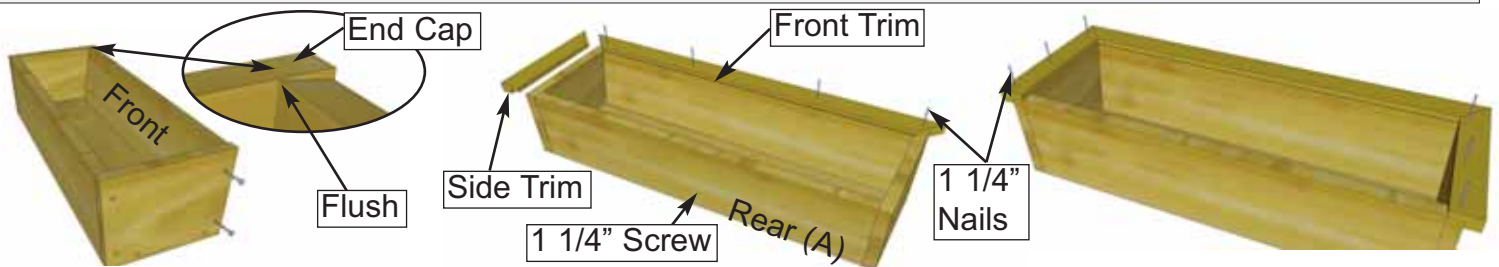

2. Position Front Frame Piece flush with End Cap. Attach both ends with 2 - 1 1/4" screws. Pilot hole Rear Box Frame near bottom center and secure to Base edge with 1 - 1 1/4" screw. Evenly position Front Trim (mitre cut on end and dado cut on inside bottom) tight against front frame and nail down with 4 - 1 1/4" nails. Position Side Trims as per Front and secure with 3 - 1 1/4" nails per side.

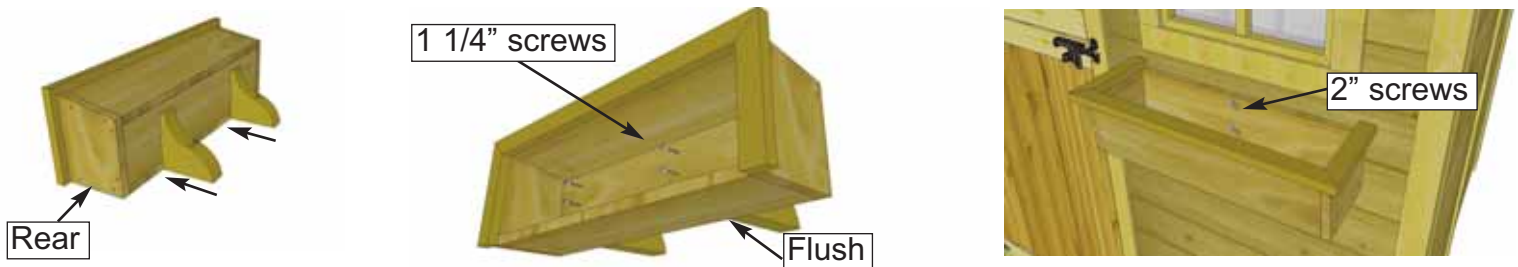

3. On a flat surface, flip Flower Box on it's rear face. Evenly space Brackets and secure through Base Frame and into the Brackets with 2 - 1 1/4" screws per Bracket. Position completed Flower Box beneath window trim and screw from inside of box into the center wall stud with 2 - 2" screws. (2" screws supplied with Base Kit.)



Congratulations on assembling your 9x6 Cabana!

Note: Our Sheds are shipped as unfinished products. If exposed to the elements, the western red cedar lumber will weather to a silvery-gray color. If you prefer to keep the cedar lumber looking closer to the original color, we suggest that you treat the wood with a good oil base wood stain. You may also wish to paint your new shed rather than stain it. In both cases we recommend that you consult with a paint and stain dealer in your area for their recommendations.

We hope your experience assembling your 9x6 Cabana Garden Shed has been both positive and rewarding.



We value your feedback and would like to hear back from you on how well we are doing in the following areas:

1. Customer Service
2. On Time Shipping
3. Motor Freight Delivery
4. Quality of Materials
5. Assembly Manual
6. Overall Satisfaction.

Please call, write or email us at:

Outdoor Living Today

Canadian Address
9393 287th Street
Maple Ridge, British Columbia
Canada V2W 1L1

United States Address
P.O. Box 96
Sumas, Washington
USA 98295



The materials contained in this Assembly Manual may be downloaded or copied provided that ALL copies retain the copyright and any other proprietary notices contained on the materials. No material may be modified, edited or taken out of context such that its use creates a false or misleading statement or impression as to the positions, statements or actions.