



6x9 Sunflower Playhouse - T&G Outdoor Living Today Assembly Manual

Revision #1.1
Apr 28, 2022

Thank you for purchasing a 6x9 Sunflower Playhouse. Please take the time to identify all the parts prior to assembly.



Safety Points and Other Considerations

Our products are built for use based on proper installation and normal residential use, on level ground. Please follow the instruction manual when building your shed and retain the manual for future maintenance purposes.

Some of the safety and usage measures you may wish to consider include:

- Snow load ratings vary by geographical location. If heavy or wet snowfall occurs, it is advisable to sweep the snow off the roof(s).
- If the product is elevated, any structural and building code requirements are solely the customer's responsibility, and should be abided by.
- In high or gusty wind conditions it is advisable to keep the structure securely grounded.
- Have a regular maintenance plan to ensure screws, doors, windows and parts are tight.

Customers agree to hold Outdoor Living Today and any Authorized Dealers free of any liability for improper installation, maintenance and repair of any products sold by Outdoor Living Today.

In the event of a missing or broken piece, simply call the Outdoor Living Today Customer Support Line @ 1-888-658-1658 within 30 days of the delivery of your purchase. It is our commitment to you to courier replacement parts, free of charge, within 10 business days of this notification. Replacement parts will not be provided free of charge after the 30 day grace period.

**Thank you for purchasing a 6x9 Sunflower Playhouse.
Please take the time to identify all the parts prior to assembly.**

Parts Lists:

A. Floor Section

- 3 - 35" x 75" Floor Joist Frames
- 3 - 1 1/2" x 3 1/2" x 72" Floor Joists
- 2 - 35" x 75" Plywood Floor Pieces
- 13 - 1" x 5 1/2" x 34 1/8" Deck Boards for Porch
- 3 - 1 1/2" x 3 1/2" x 48" & 57" Floor Runners (3 each size)

B. Wall Section

- 4 - 35" x 60" Solid Wall Panels (Bottom Wall Plates Unattached)
- 4 - 1 1/2" x 2 1/2" x 35" Bottom Wall Plates
- 3 - 35" x 60" Window Wall Panels
- 1 - 10" x 58 1/2" Narrow Porch Wall Panel
- 1 - 1 1/2" x 2 1/2" x 58 1/2" Left Side Door Jamb
- 1 - 1 1/2" x 2 1/2" x 35" Door Header
- 1 - 23" x 32 1/2" Bottom Door
- 1 - 23" x 25" Top Door
- 1 - 1/2" x 2" x 33" Above Door Filler Trim
- 1 - 1 1/4" x 1/4" x 23" Threshold for Doorway (angle cut on edge)

Gable Wall Panels

- 1 - Rear Gable Wall (Triangular Shaped with Designer Shingles)
- 1 - Middle Gable Wall (Triangular Shaped with Regular Siding)
- 1 - Decorative Front Gable (Designer Shingles)

Top Wall Plates

- 1 - 3/4" x 2 1/2" Rear Top Plate (Angle cut on end 75")
- 1 - 3/4" x 2 1/2" Front Top Plate (Straight cut on end 70")
- 4 - 3/4" x 2 1/2" Side Top Plate (Angle cut on length 50 3/4")

C. Rafter and Roof Section

- 18 - 1 1/2" x 2 1/2" x 44 7/8" Rafters (angle cut on ends)
- 2 - 3/4" x 3 1/2" x 44" - Ridge Boards
- 2 - 3/4" x 3 1/2" x 61" - Ridge Boards
- 4 - 1/2" x 4 1/2" x 52 1/2" Soffits (Both Sides)
- 4 - 3/4" x 2 1/2" x 36" Facia/Roof Nailing Strips

Roof Panels

- 4 - 41" Outside Roof Panels (Shingles overhanging Roof Plywood on 1 end)
- 2 - 35" Middle Roof Panels (Shingles flush with Roof Plywood)

D. Porch Section

- 2 - 3 1/2" x 3 1/2" x 58 7/8" Porch Posts (long)
- 1 - 3 1/2" x 3 1/2" Deck Post (short)
- 3 - Hand Rail Sections (30" w x 22)
- 2 - 3/4" x 3 1/2" x 34 1/2" Top Plate Front Extensions
- 1 - 1" x 4 1/2" x 58 7/8" Front Wall Trim/Support (includes 4 1/2" Filler Strip Attached to back)
- 1 - 1 1/8" x 4 1/2" x 58 7/8" Front Wall Trim/Support (includes 2 1/2" Filler Strip Attached to back)
- 4 - Corner Brackets
- 12 - 1/2" x 1 1/2" x 4" Post Base Trims
- 2 - Sheets (34 1/2" x 37" x 1/8") for Porch Ceiling
- 3 - 1 1/2" x 3 1/2" x 3 1/2" Rail Support Blocks

E. Miscellaneous Section

Ridge Caps

- 1 Bundle Cedar Shingle Roof Ridge Caps - 18 pcs

Bottom Skirting

- 2 - 1/2" x 4 1/2" x 38" Front Bottom Skirting
- 8 - 1/2" x 4 1/2" x 34 3/4" Bottom Skirting

Corner & Sidewall Trim

- 7 - 1/2" x 2 1/2" x 64" Rear / Sidewall Trims
- 2 - 5/8" x 2 1/2" x 60" Back Wall Filler Trims
- 2 - 1/2" x 4 1/2" x 67" Back Wall Wide Corner Trims
- 1 - 1/2" x 2 1/2" x 67" Horizontal Trim above Door & Window Wall
- 1 - 1/2" x 2 1/2" x 58" Front Wall Porch Trim
- 1 - 1/2" x 2 1/2" x 58" Front Door Porch Trim

Facia Trim

- 4 - 3/4" x 3 1/2" x 46" Rear Facia (Angle cut on ends)
- 4 - 3/4" x 3 1/2" x 57" Side Facia

Filler Shingles (5 1/2" wide)

- 12 pcs Long Filler Shingles
- 4 pcs Short Filler Shingles













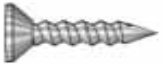

****Miscellaneous Pieces**

- 3 - Window Inserts
- 3 - Window Trim Pkgs - (1-24 1/16" angle cut / 3 -23" straight cut)
- 2 - Flower Box Kits
- 2 - Pentagon Facia Plates
- 2 - Facia Detail Plates
- 1 - Spare Wall Siding
- 2 - Shim Shingles (Use to shim door, etc)









Note: All Trim, Facia and Bottom Skirting pieces will be positioned rough face out when installed.

6X9 SUNFLOWER HARDWARE PACKAGE

Hardware Kit (Provided)

- | | | | | | |
|--------|--|------------------------|--------|--|---------------------------|
| 2 1/2" |  | 198 pcs | 1 1/2" |  | 402 pcs |
| 2" |  | 170 pcs | 1 1/2" |  | 50 pcs |
| 1 1/4" |  | 212 pcs | |  | 1 pc |
| 3/4" |  | 30 pcs | |  | Single Rafter Bracket x 4 |
| 3/4" |  | 38 pcs
Black Headed | |  | Double Rafter Bracket x 2 |
| |  | Door Hinge x 4 | |  | Door Handle (1) |
| | | | |  | Simpson Strong Tie x 4 |
| | | | |  | Ridge Board Connector x 2 |

Tools Required (Not Provided)

- | | | | | |
|---|---|--|---|---|
|  |  |  |  |  |
| Hammer | Screw Gun/Drill | Tape Measure | Wood Clamp | Utility Knife |
|  |  |  |  | |
| Level | Pliers | Ladder | 1/8" Drill Bit | |

Safety Equipment Required (Not Provided)

- | | |
|---|---|
|  |  |
| Safety Glasses | Work Gloves |

A. Floor Section

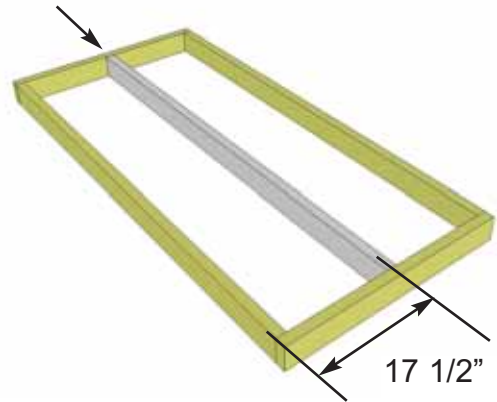
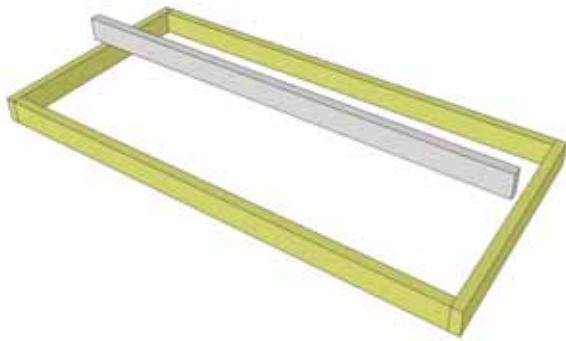

1. Floor Joist Frames require one interior **Floor Joist** attachment each. Center Floor Joist (17 1/2" from outside of Frame to center of Floor Joist) and attach with 2 - 2 1/2" screws per end. **You can find the Square Drive Bit for the screws in with the Hardware Kit Bag.**

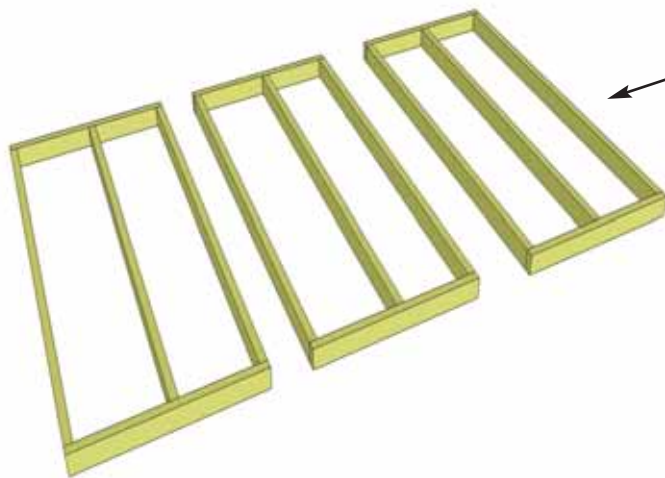

2. Lay out Floor Joist Frames as illustrated in left picture.

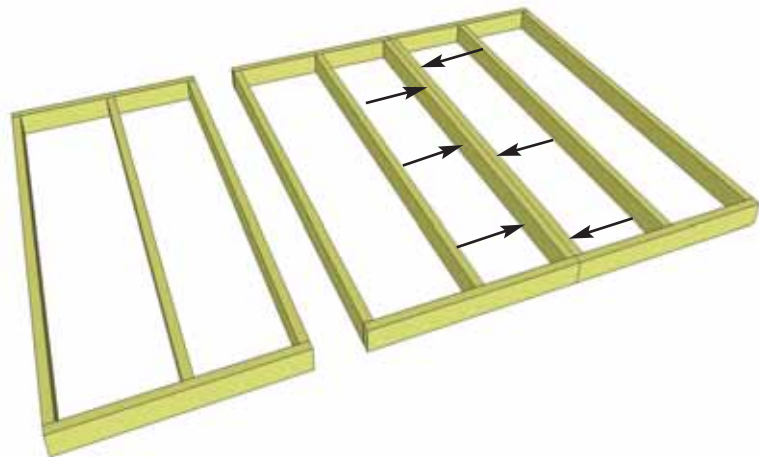

You can find the Square Drive Bit for the screws in with the Hardware Kit Bag.

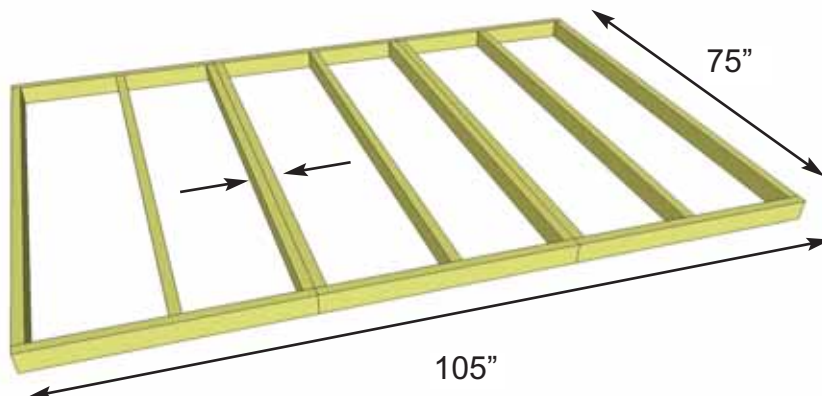

3. Attach the Floor Joist Frames together with 6 - 2 1/2" screws per section. Attached, your Floor Joist section should be **75" wide x 105" deep.**

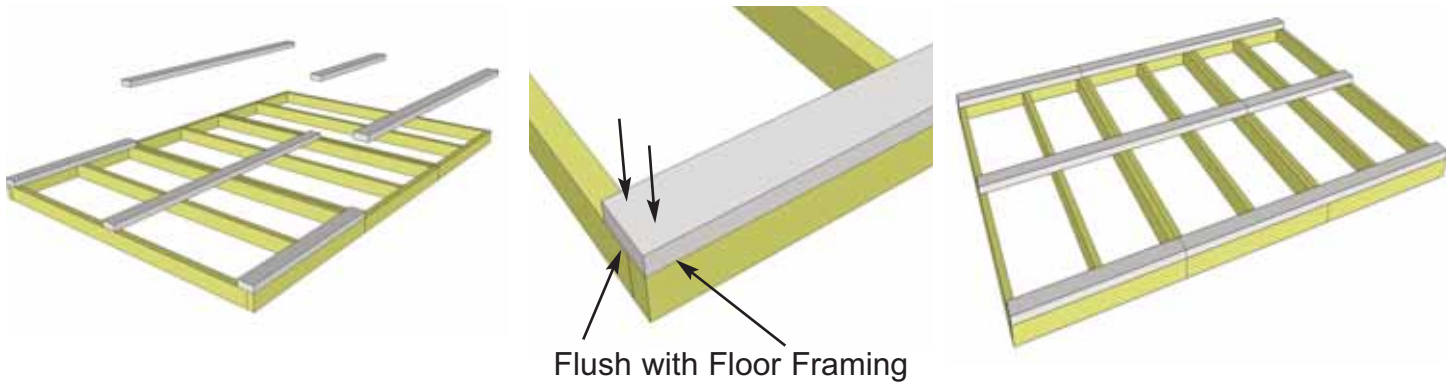

4. Attach **Floor Runners** to completed Floor Joist Frames. There are two Floor Runners per 105" side and three completed Floor Runners in total. Use 6 - 2 1/2" screws per Runner to secure.

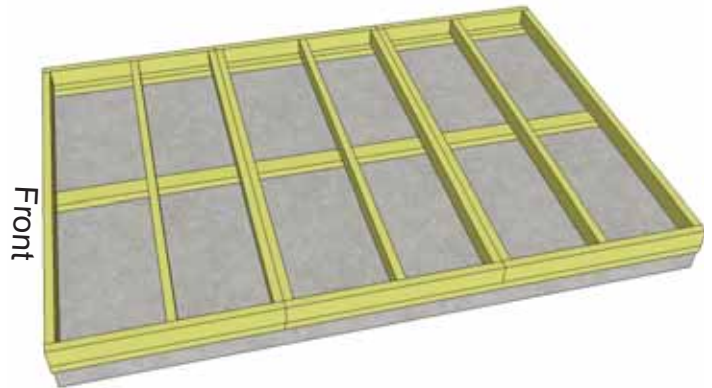

Foundations

NOTE: The floor will be flipped over and Floor Runners will sit on your foundation. It is important to note that having a level foundation is critical. Choosing a foundation will vary between regions. Typical foundations can be concrete pads or patio stones positioned underneath the Floor Runners.

5. With Floor Runners attached, carefully flip the floor over and place on your foundation. **CAUTION:** You will need two people to assist you. Be careful not to bend or twist the floor when laying floor down. When in place, level floor completely.

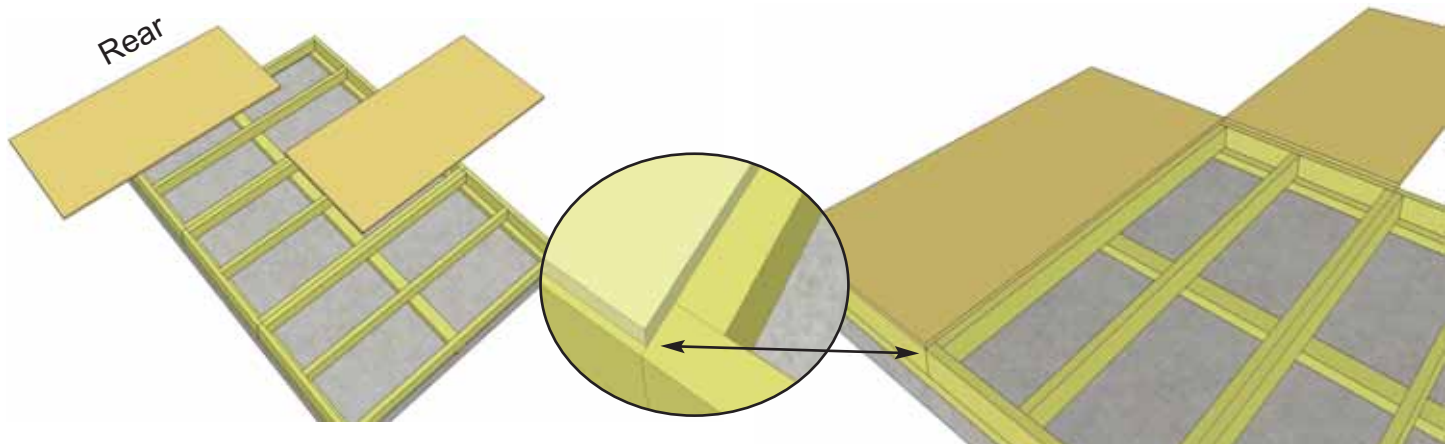

6. Position **Plywood Floor** pieces (2) on top of completed Floor Joists. Plywood is cut slightly smaller than floor framing. Keep plywood seam tight.

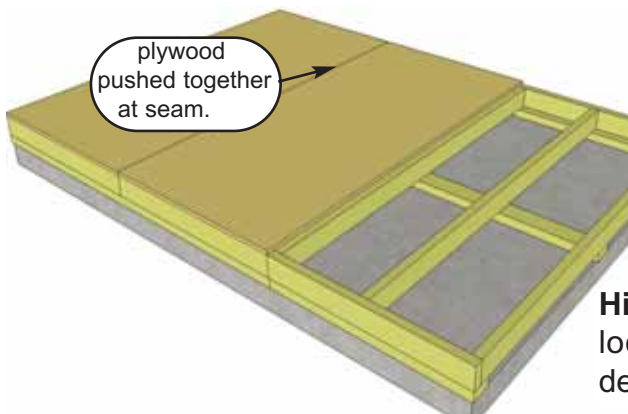

Hint: Use a chalk line to mark location of floor joists to determine screw placement.

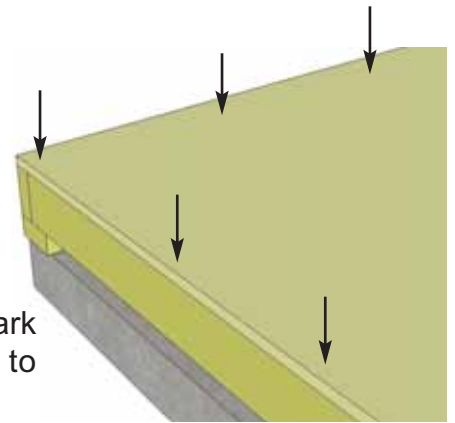

7. When Plywood Floor is correctly positioned, attach with 1 1/4" screws. Use screws every 16".

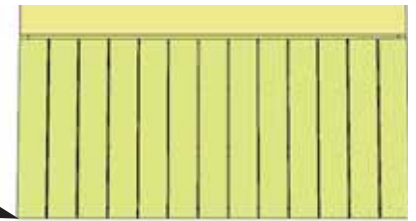
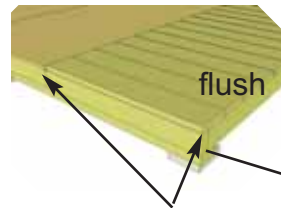
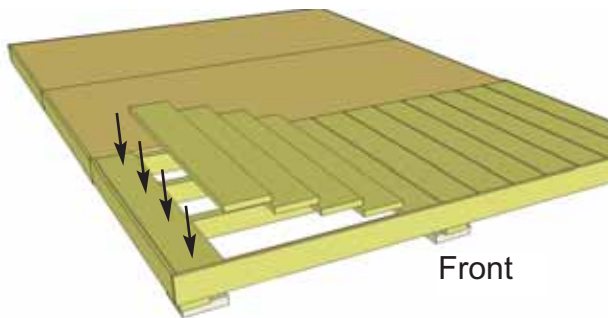

Make sure deck boards are flush to the front and sides of the floor frame. There will be a gap between the plywood and the deck boards.

8. Attach thirteen pieces of 1 x 5 1/2" **Decking** flush to front using 4 - 2" screws per piece. With Decking, attach both outside pieces first and equally space all others on the floor before attaching.

NOTE: When floor is completed, make sure it is still level and make adjustments if required.

B. Wall Section

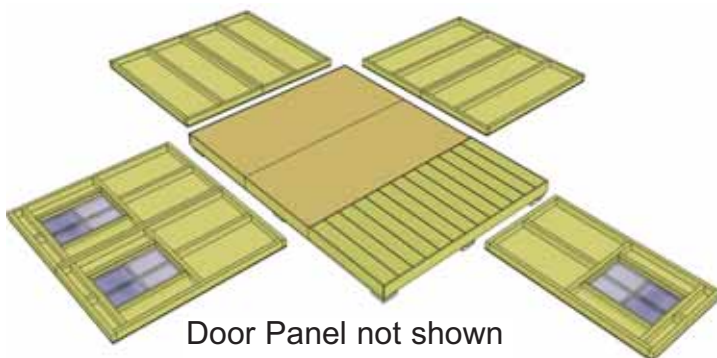

9. Lay out all the Wall Panels and become familiar with their location. On Standard Kits, there are **3 Window Wall Panels** and **4 Solid Wall Panels**. All wall panels are 35" wide x 60" high and can be placed in any location, except for the **Door Panel** (not shown to the left). The Door Panel must be positioned to the left front. **NOTE:** You must attach **Wall Plates** to the bottom of all Solid Wall Panels. **Window Inserts** for Window Walls will need to be positioned and attached as Per **Step 11**.

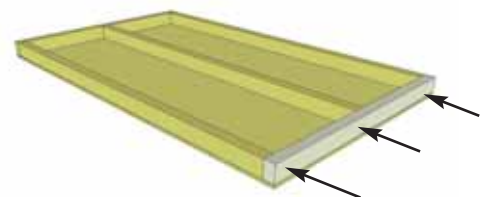
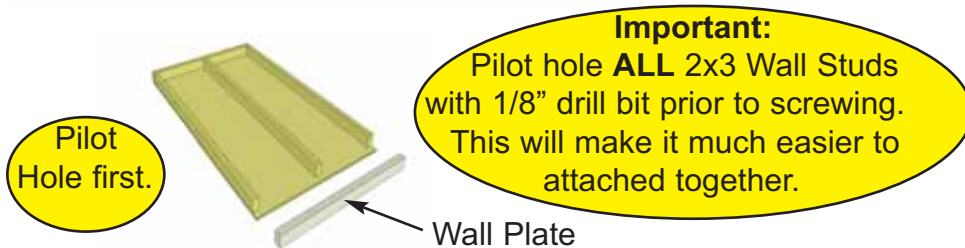

10. Starting with **Solid Wall Panels**, carefully lay panel face down. Position and attach **Wall Plate** to bottom of wall studs of each Panel with 3 - 2 1/2" screws. Position so plates are flush with framing.

Note: We recommend you wait to install the windows last, so they don't get damaged during construction.

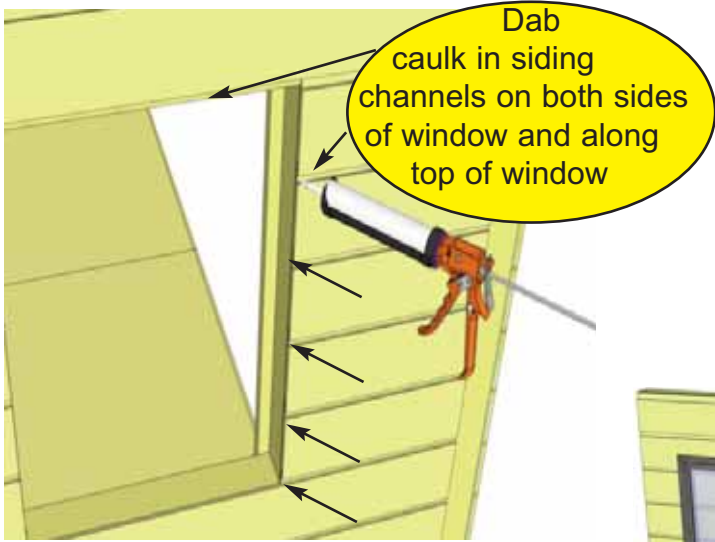

11. Locate **Window Inserts for Window Walls.**

Before installing, dab caulk in siding channel on both sides and across top of window opening. This will prevent water from getting in behind window. Position window in cavity and secure with 8 - 1 1/4" screws. Window Trims in Step 21 will be installed to hide caulking. Complete Window Inserts as walls are erected or completed.

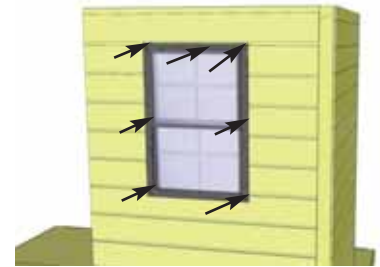
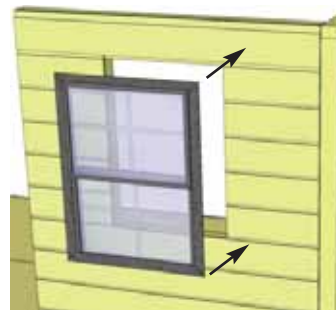

11a. Position Window Trim around window doing a dry run first and attach with 4 - 1 1/2" finishing nails per piece. The window kit trim pack = 1x 24 1/16" = top / 3 x 23" = sides and bottom. Window trim has a small dado on reverse face. Outside flange of window will roughly sit in the dado to give a better fit.

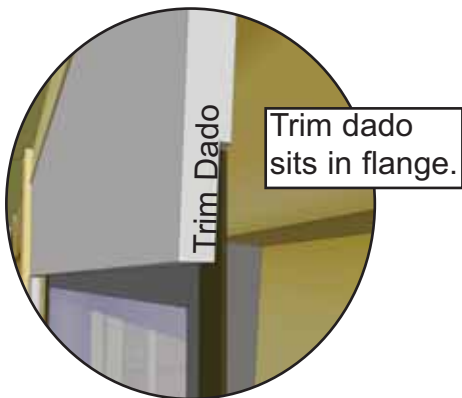

12. Starting at rear corner, position a **Wall Panel** on top of plywood floor. Depending on your preference, you may use a **Solid** or a **Window Wall Panel** in this position. If using a Solid Wall, make sure panel is facing up.

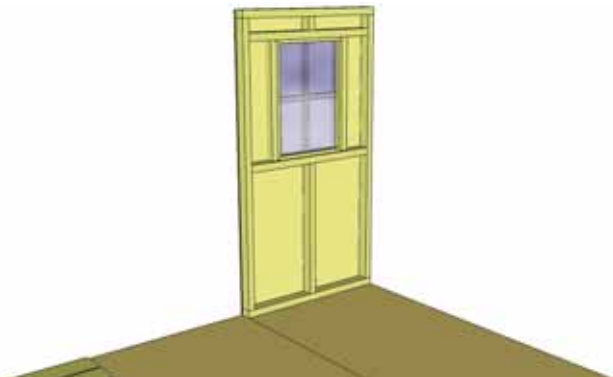

IMPORTANT: Make sure all walls are aligned in their upright position. If they aren't, water may leak into your playhouse. Unsure if panel is facing up or down? Check siding on Window Wall Panel to match alignment.

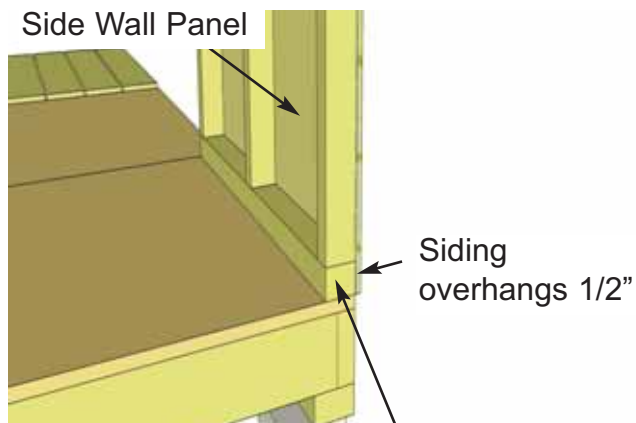

Frame of Wall Panel will be flush with outside of Floor Frame when properly aligned.

13. The Side Wall Panels will sit flush at the end of the Plywood Floor with the front and rear panels sandwiched between them. **NOTE:** Siding will overhang the floor by approx. 1/2". Position Rear Solid Wall on floor in corner and attach vertical wall studs together with 3 - 2 1/2" screws.



Pilot Hole first.

vertical wall stud

Screw at the top, middle and bottom of 2x3 stud. **Do Not Attach Walls To Floor Until Step 17.**

Optional: Caulking seams will help prevent moisture from entering your shed. **Caulking not included in kit.**

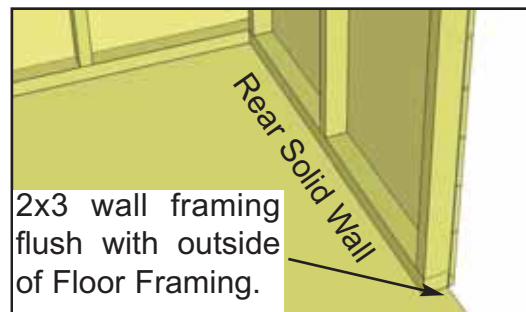
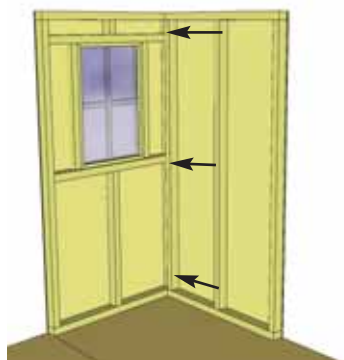
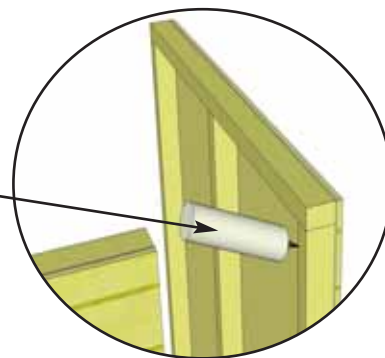

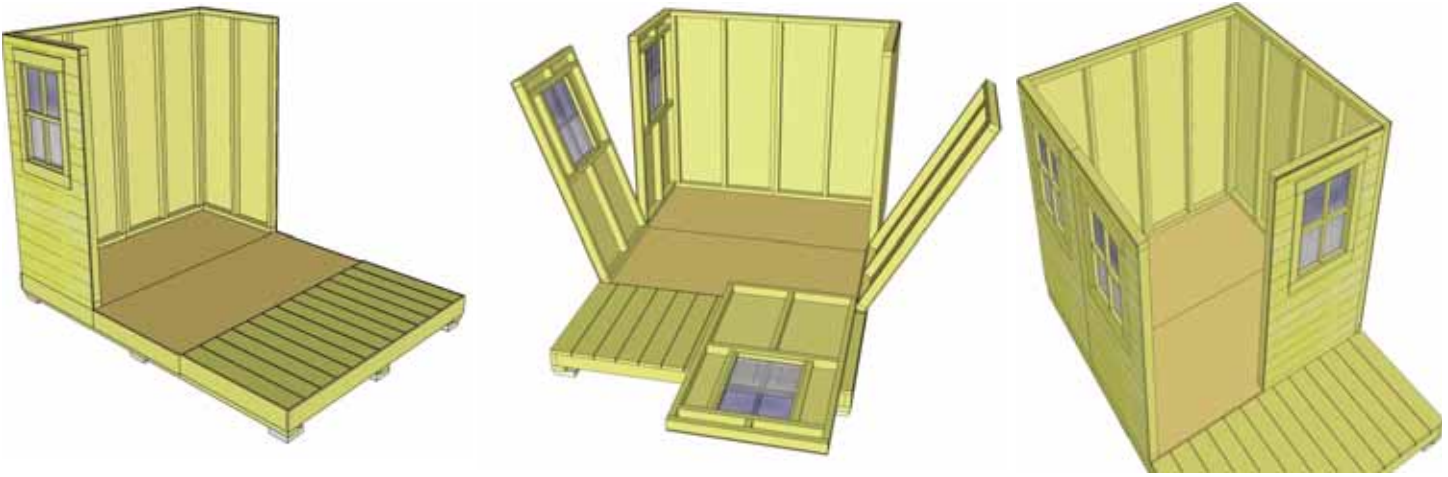

14. Continue to attach walls, working your way around the playhouse. Once again, screw walls together using 2 1/2" screws at the top, middle and bottom of Wall Studs.

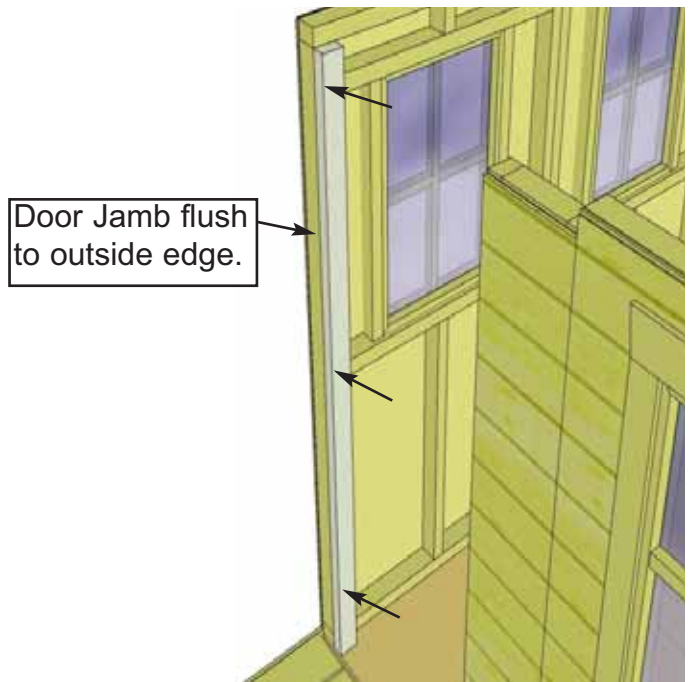
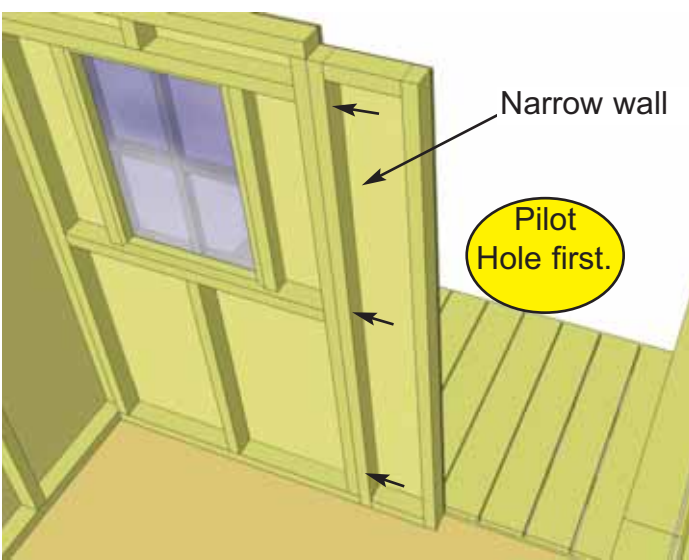

15. To attach the Door, first position the **10" wide Narrow Wall** next to the Window Wall and screw into adjoining wall stud with 3 - 2 1/2" screws.

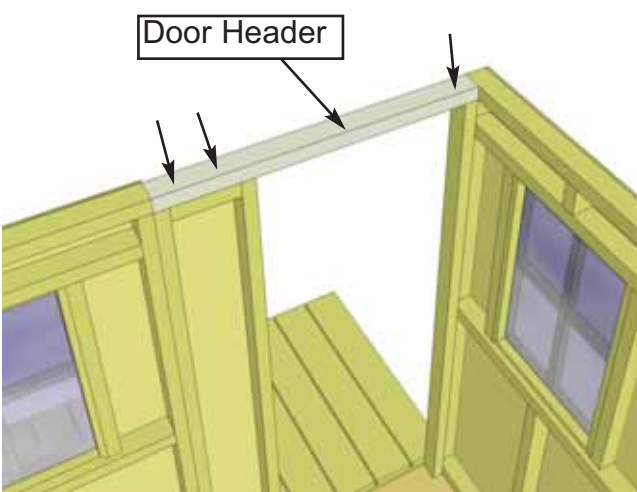

16. Attach the **Left Side Door Jamb** to Left Side Wall Stud. Make sure Door Jamb is flush with floor and flush with existing wall stud. Use 3 - 2 1/2" screws to secure. Next, attach the **Door Header** to Door Jamb and Top Plate of Narrow Wall. Use 3 - 2 1/2" screws to secure. **IMPORTANT:** Check door opening measurement at top and bottom. It should be 23 1/2".

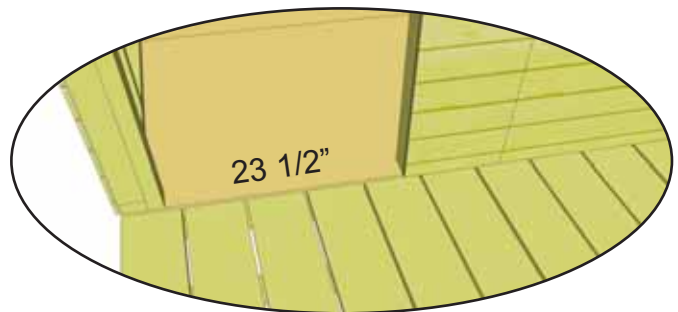

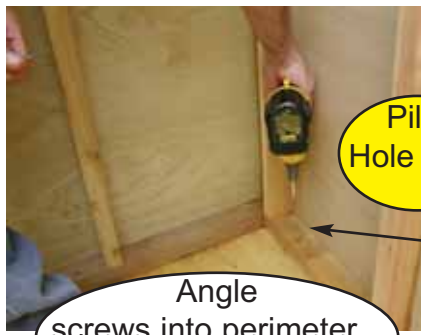

Angle screws into perimeter Floor Joists.

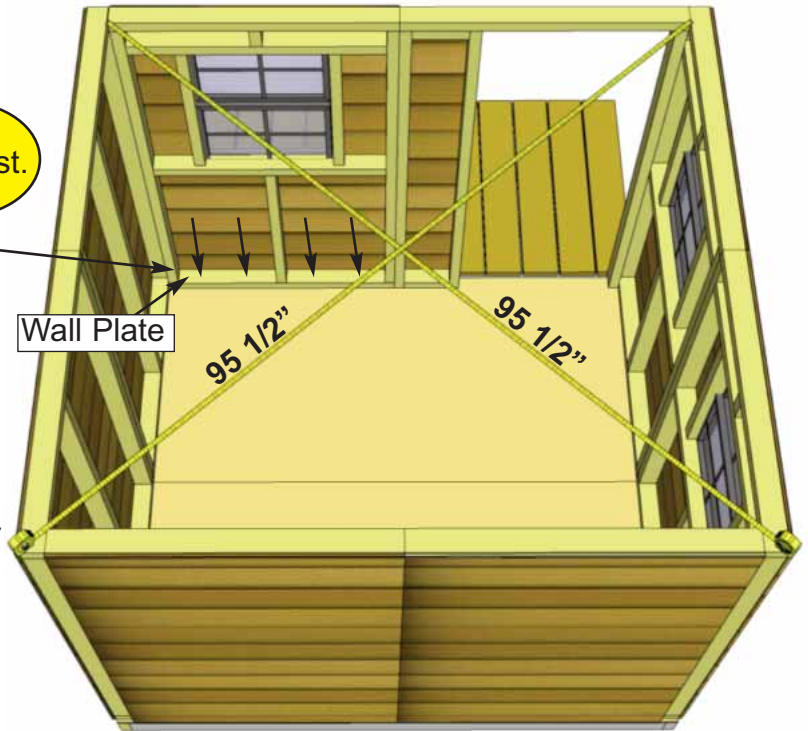

17. When all walls are attached together, check alignment with the floor. Bottom Wall Plates should sit flush with outside of Floor Framing. When positioned correctly, fasten Bottom Wall Plates to floor using 4 - 2 1/2" screws per Wall Panel.

Optional - Caulking seams will help prevent moisture from entering your shed. **Caulking not included in kit.**



Advice: Prior to fastening walls and installing rafters, take time to confirm your walls are level, square and plumb.

Measure diagonal at top and bottom of walls corner-to-corner. This should be approximately 95 1/2". More importantly, if measurements are not within 1/4", your walls are not square. Adjusting now will make it easier to the roof section later.

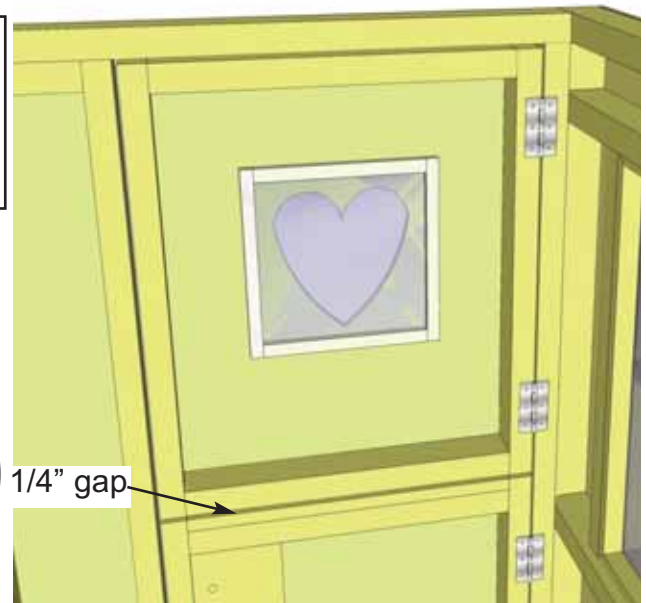
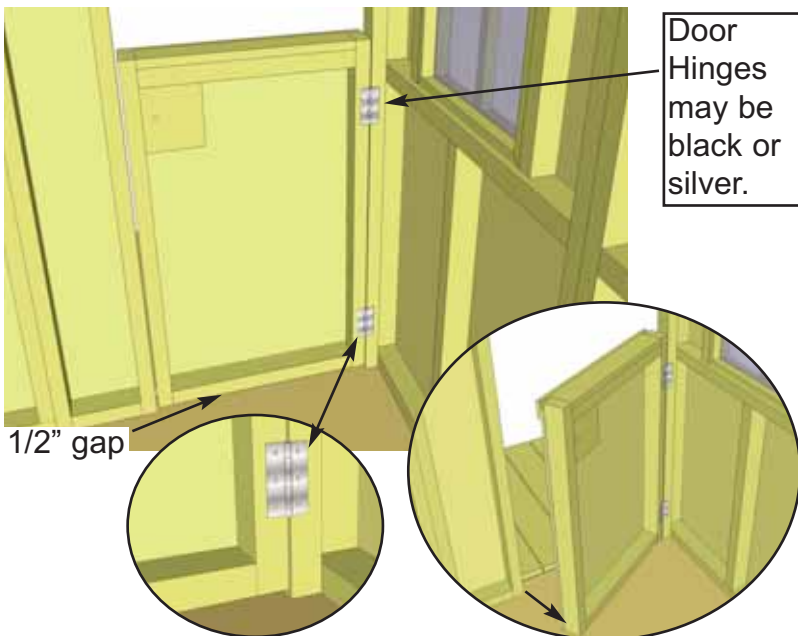

18. Attach 2 Hinges (top and bottom) to Bottom Door framing with 3/4" Black Headed Screws. Position the Door into door opening. Leave a 1/2" gap between floor and bottom of door framing. Use Spare Shingle to help shim door into proper position. Initially, secure Door to Door Jamb with one screw per hinge. Check door alignment by moving door back and forth. When satisfied with position, completely secure Door to Door Jamb. Follow same procedure for Top Door leaving 1/4" gap between doors.

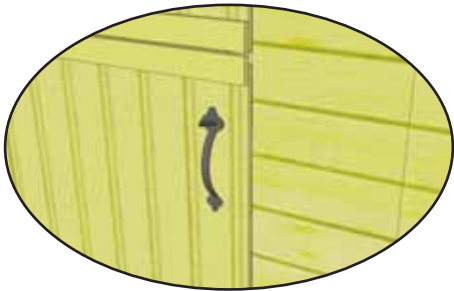
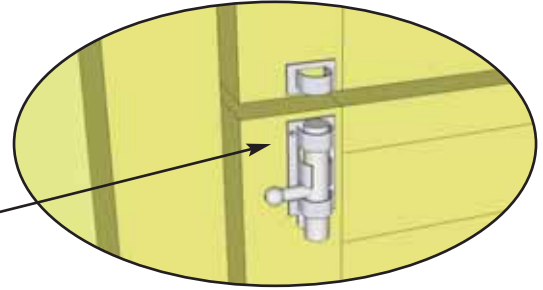

19. Attach **Door Handle** and **Interior Silver Barrel Bolt** Hardware. Use 3/4" Black Headed Screws to secure the Door Handle. **Important:** Drill shallow Pilot Holes to prevent wood from splitting. Align male and female Barrel Bolt to Door Framing. Attach with 3/4" Black Headed Screws.

20. Position angle cut **Rear Top Plate** (rear only) on top of wall studs so it is flush on the inside with 2x3 Wall Plate. The Rear Top Plate has an angle cut on the ends. Attach by screwing down into top Wall Plate with 4 - 2" screws.

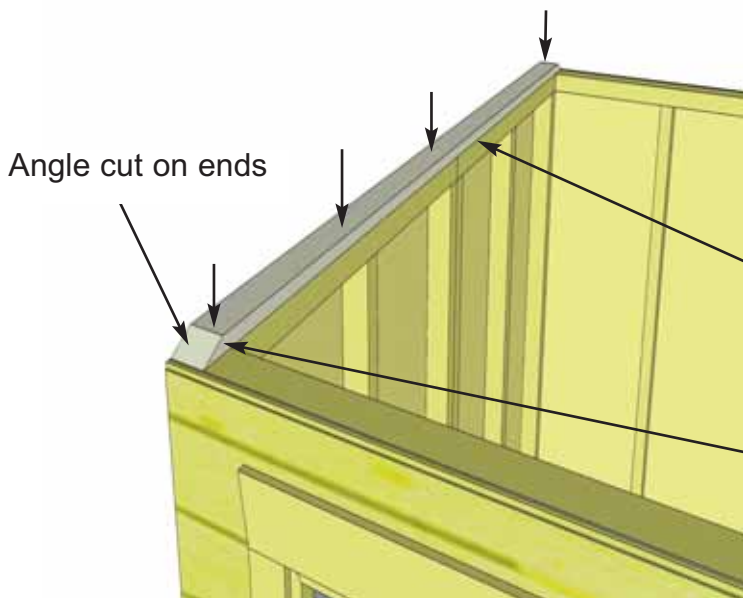

Angle cut on ends



Rear Top Plate should be flush with inside of Wall Framing.

Important: when attaching Top Plates, have end screws tie into Side Walls.

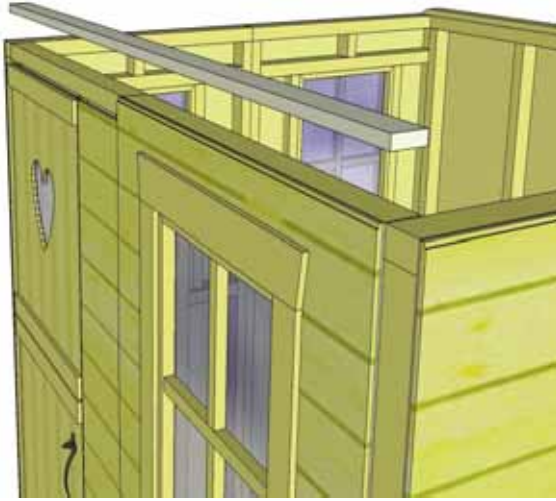

21. Position the **Front Top Plate** on top of Door and Front Wall Panel. Front Top Plate is straight cut on the ends and is 70" long. Once again, the Top Plate will be flush with inside of Top Wall Plate. Attach with 4 - 2" screws into Header and Wall Framing.

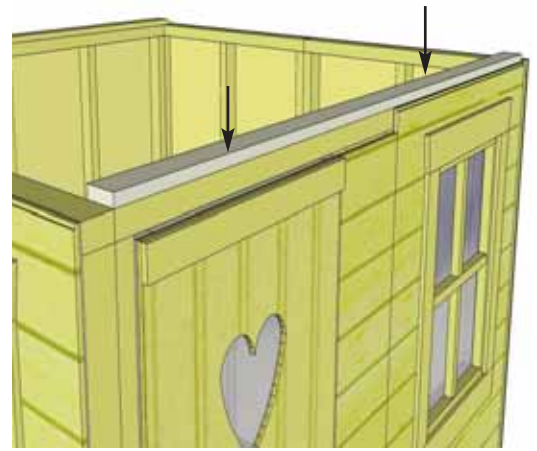

22. Next, attach the four **Side Top Plates** (2 per side). The Side Top Plates are angle cut down the length. Once again, position Top Plate on Wall Plate so it is flush with inside of Wall Plate. Side Plate should also be flush with Rear Wall Plate.

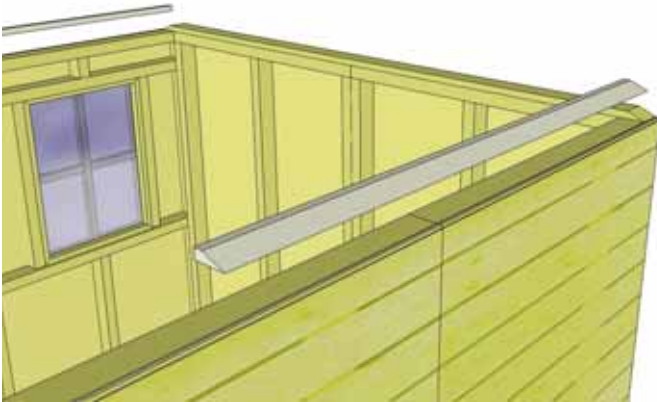

When in correct position, screw down plate with 4 - 2" screws per piece.

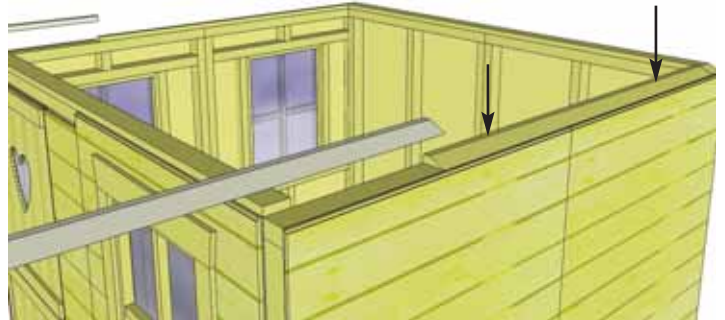

23. Complete all Side Top Plate attachments as described above.

CAUTION: Side Top Plates will be protruding out from the playhouse. Please use caution in the work area.

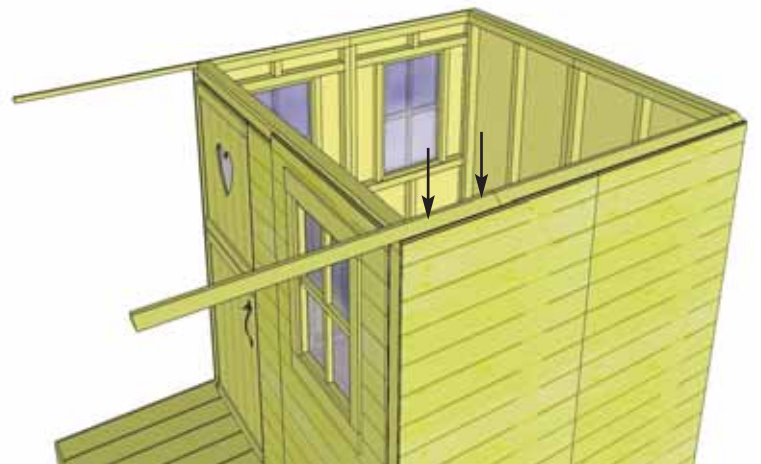

24. Complete the **2 Porch Rail Sections**, following steps **A** through **D**. **Note:** Sections differ - see step B for orientation.

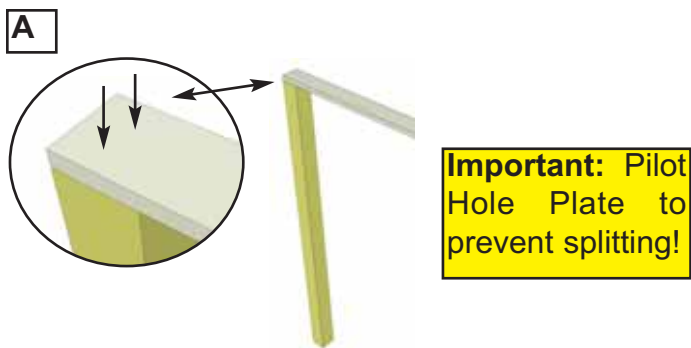

A. Attach 1x4 **Top Plate Front Extension (34 1/2" L)** to 4x4 Porch Post with 2 - 2" screws. Make sure support is flush with post.

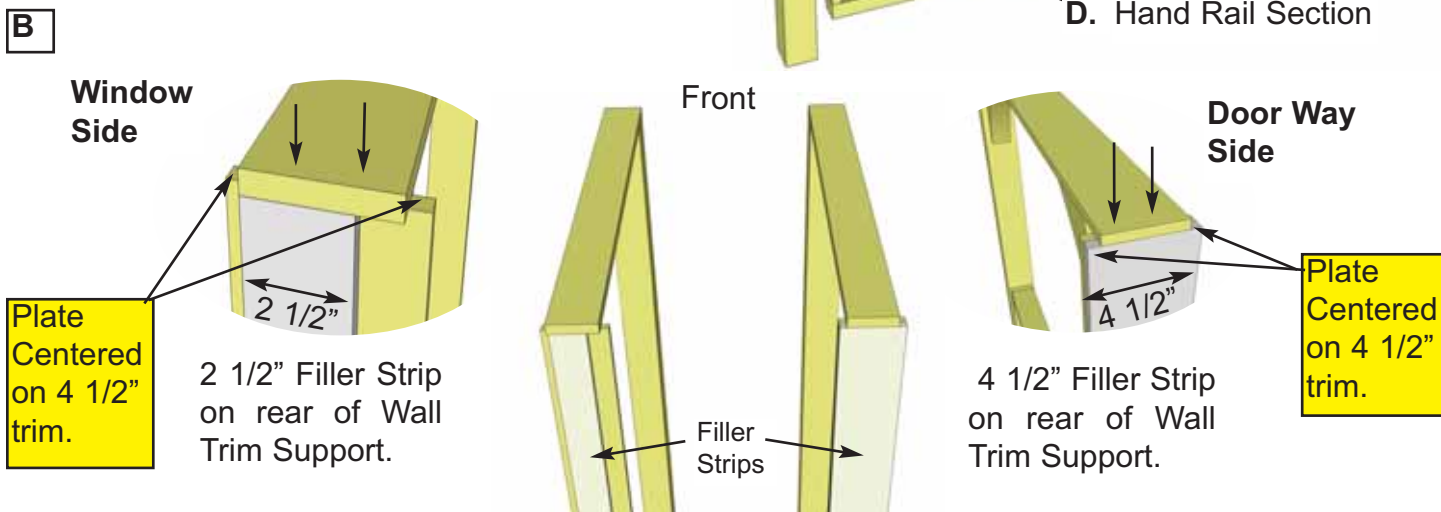
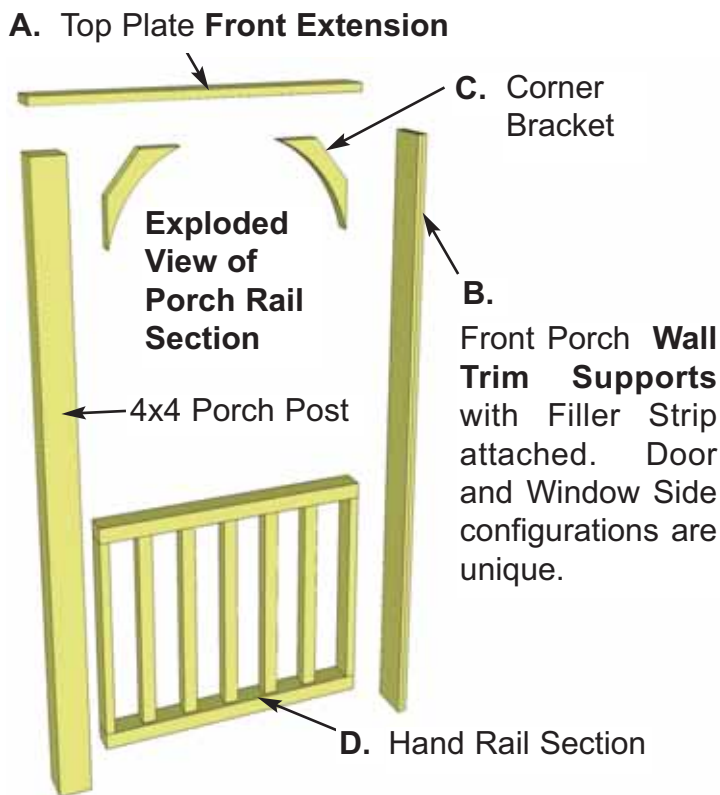

B. Attach 1x4 1/2" **Wall Trim/ Supports** to Front Extension using 2 - 2" screws. Make sure Front Extension is Flush to back of wall trim and centered 1/2" on each side. **Note:** there are 2 different wall supports for left & right. See diagram for proper orientation.

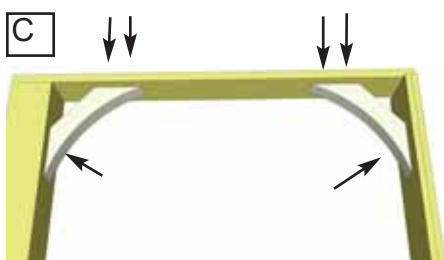

C. Attach both **Corner Brackets** with 2 - 2" screws from Front Extensions into Brackets, and 1 - 2" screw into vertical posts. Drill Pilot hole in bracket first.

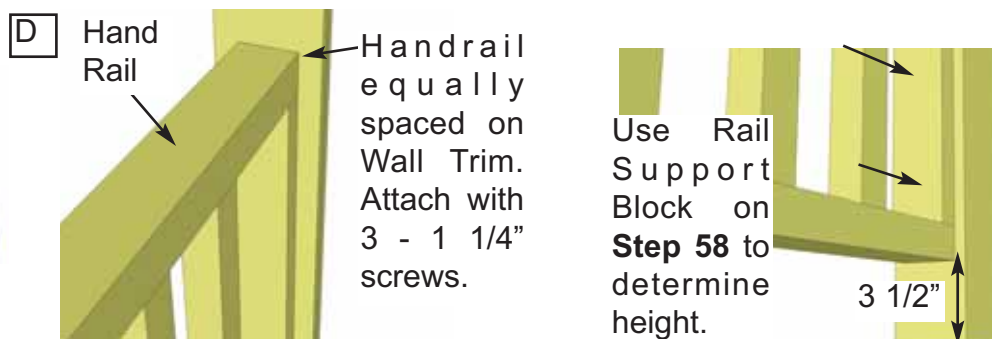

D. Attach **Hand Rail** to complete your Porch Rail Section. Handrail should start 3 1/2" from bottom of Post and be centered on Trim and Post. Attach with 3 - 1 1/4" screws on Trim side, and 3 - 2" screws on Post side.



25. When both Porch Rail Sections are complete, lift into place on Playhouse Deck and beneath the Side Top Plate. **(Window Side section will have Narrow Filler Trim).** Position so Post is flush with Decking on the side and recessed 1/2" in the front. Attach wall support to playhouse wall with 3 - 2 1/2" screws. Try to conceal screws if possible.

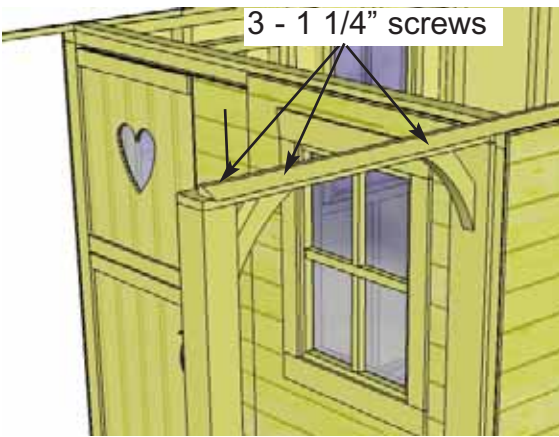
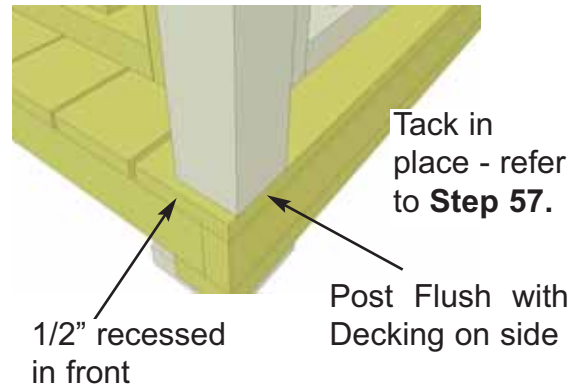

Screw Side Top Plate into porch section with 3 - 1 1/4" screws. Screw into Corner Brackets and Post to conceal screws. Complete the other Porch section.



The Rear Gable Framing should sit flush with the inside of the Top Plate. It should also be centered sideways on the Top Plate. **HINT:** Use a straight edge to check the angle of the Gable Framing and Top Plate. Both angles should line up. Adjust gable accordingly. Attach with 2 - 2" screws.

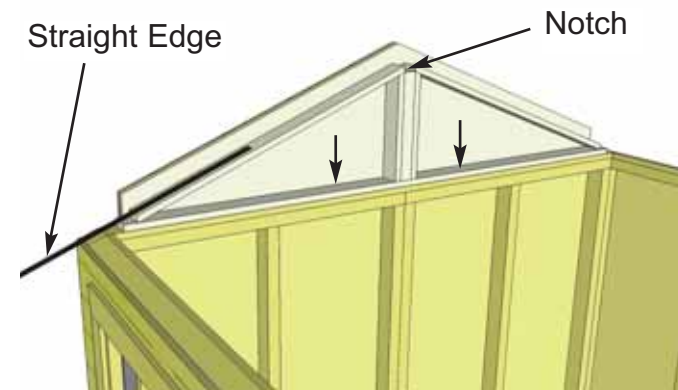

26. Position the **Rear Gable Wall** on top of the Rear Top Plate. The Rear Gable can be distinguished from the other two gables because it has Designer Shingles protruding below frame. Temporarily attach to walls and top plate with 2 - 2" screws. Gables may need slight adjustment in **Step 38**. Complete attachment when correctly aligned in **Step 38** with an additional 6 - 2" screws.

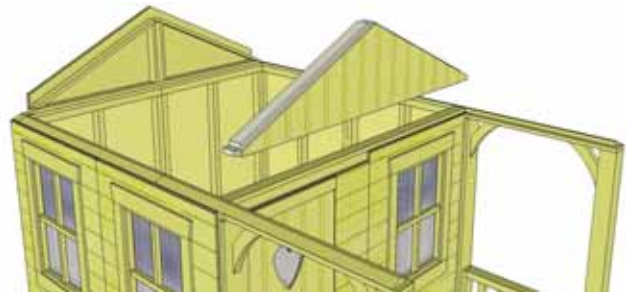
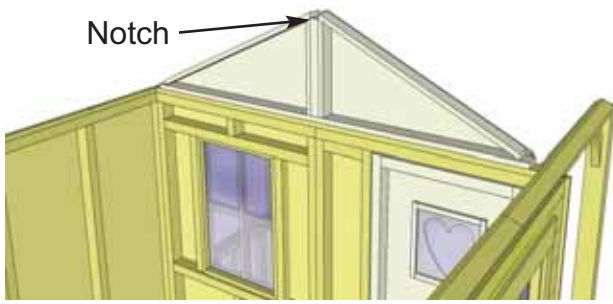

27. Position the **Middle Gable Wall** on top of Front Top Plate. When in correct position, attach with 2 - 2" screws as per **Step 26**. Complete installation in **Step 39**.

C. Rafter and Roof Section

Exploded view of all parts necessary to complete the Roof Section. Identify all parts prior to starting. (Roof Filler Shingles Missing)

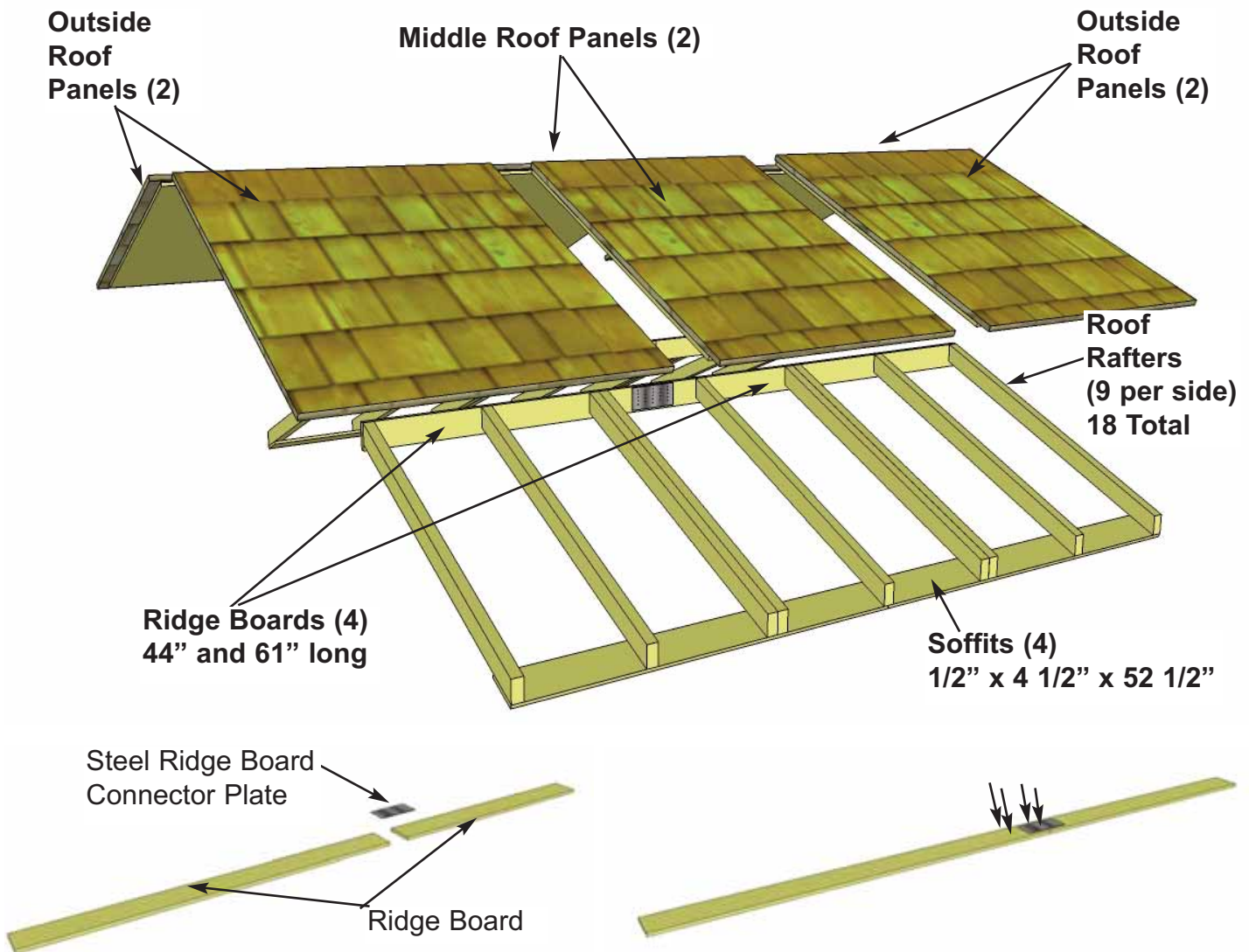

28. Locate (1 each) 3/4" x 3 1/2" x 44" & 61" **Ridge Boards** and attach together with **Steel Ridge Board Connector Plates** using 8 - 3/4" screws. Total length when connected is 105". Complete two sets.

29. Locate 9 **Rafters**, 2 **Soffits** and completed Ridge Board. Lay out on level ground as shown to the right. Double up Rafters as illustrated. Screw doubled up Rafters together with 3 - 2 1/2" screws per piece.

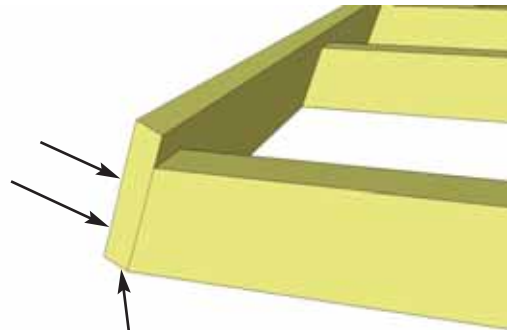
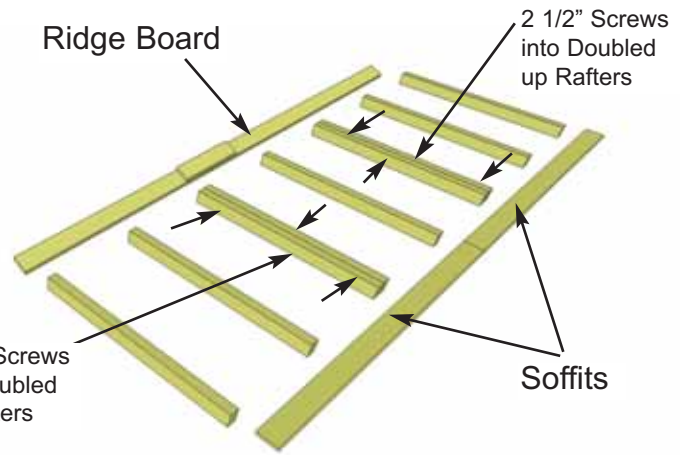

Important:
Pilot Hole
Ridge Board
to prevent
splitting!

30. Attach completed Ridge Board to ends of both outside rafters with 2 - 2" screws per end. Measure and position interior Rafters as illustrated below. When positioned correctly, attach Ridge Board to remaining rafters with 2 - 2" screws /rafter end.

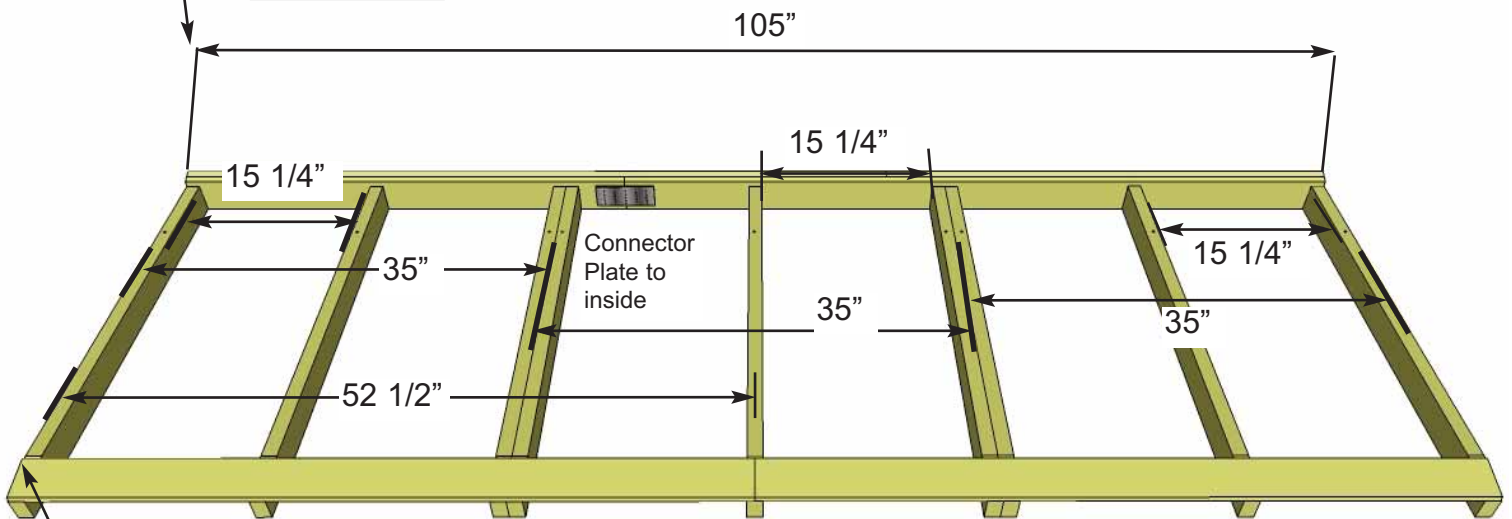

Important: Pilot
Hole Soffit to
prevent splitting!

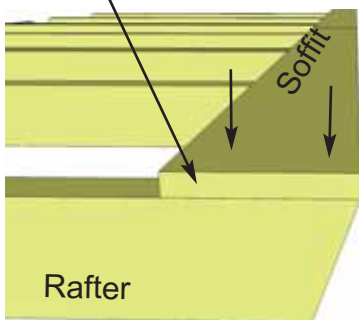

31. Attach end of a 52 1/2" long Soffit Board flush to ends of outside rafters with 2 - 1 1/4" screws per rafter end. Drill pilot hole in Soffit ends to prevent splitting. Complete both outside rafter / Soffit connections first. Measure and position interior Rafters as illustrated above. When positioned correctly, attach Soffits to remaining rafters with 2 - 1 1/4" screws /rafter. Flip completed rafter section over. Complete 2nd Rafter section now as per **Steps 29 - 31** with the following exception: **When attaching Ridge Board to Rafter ends, make sure Metal Ridge Board Connector is positioned so offset to first Rafter Section. See Step 37 for illustration.**

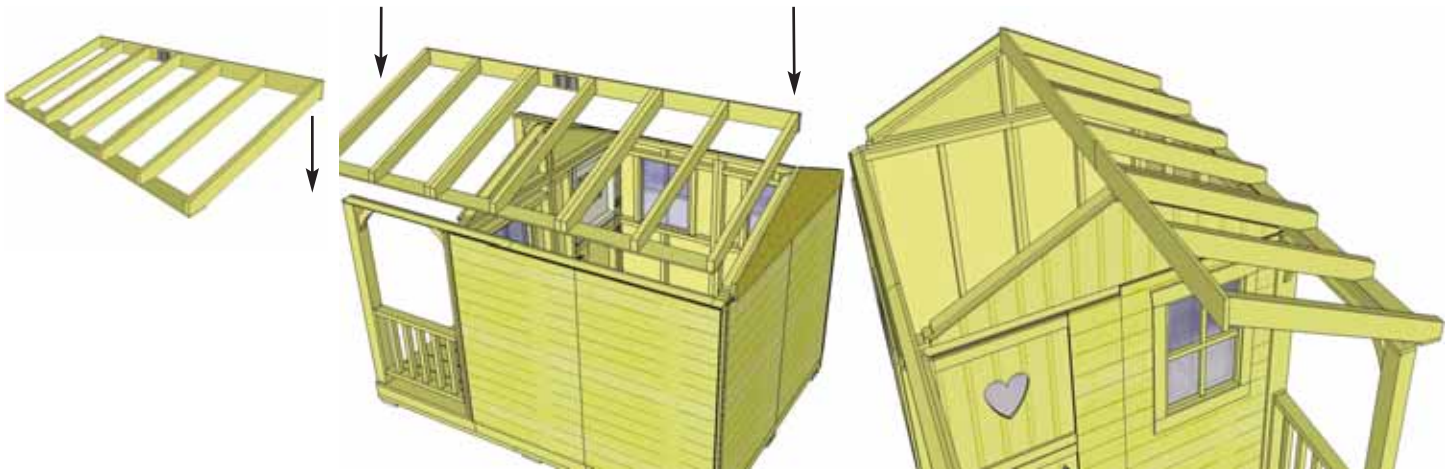

32. Flip Rafter Section over so Soffit is down. Carefully lift completed Rafter Section up and place on middle and rear Gable Framing.

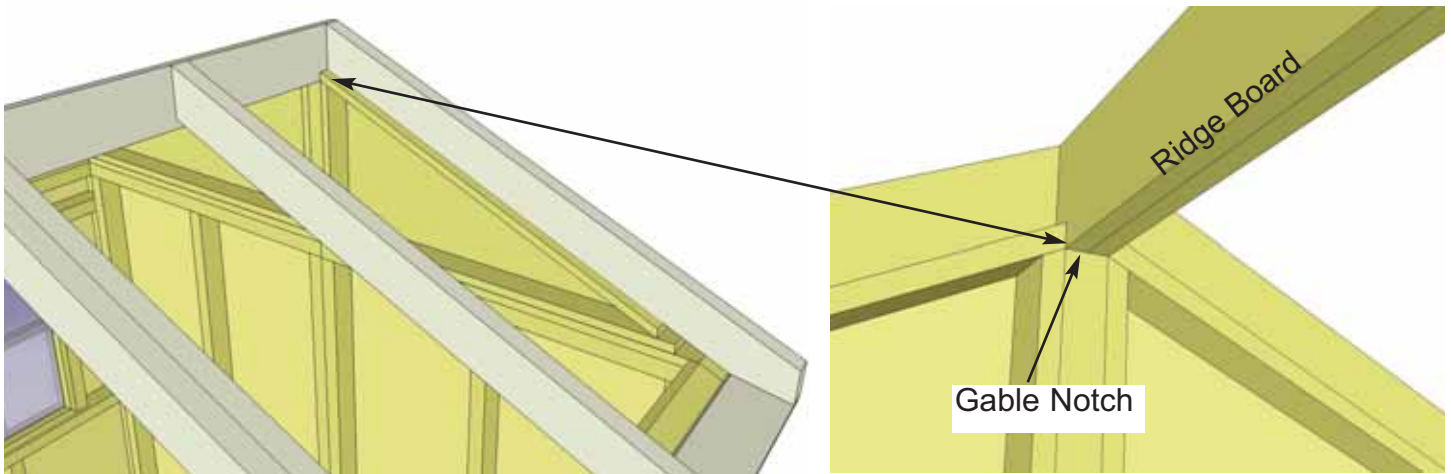

33. Slide Rafter Section up on Gable Framing until bottom of Ridge Board slips into Gable Notch.

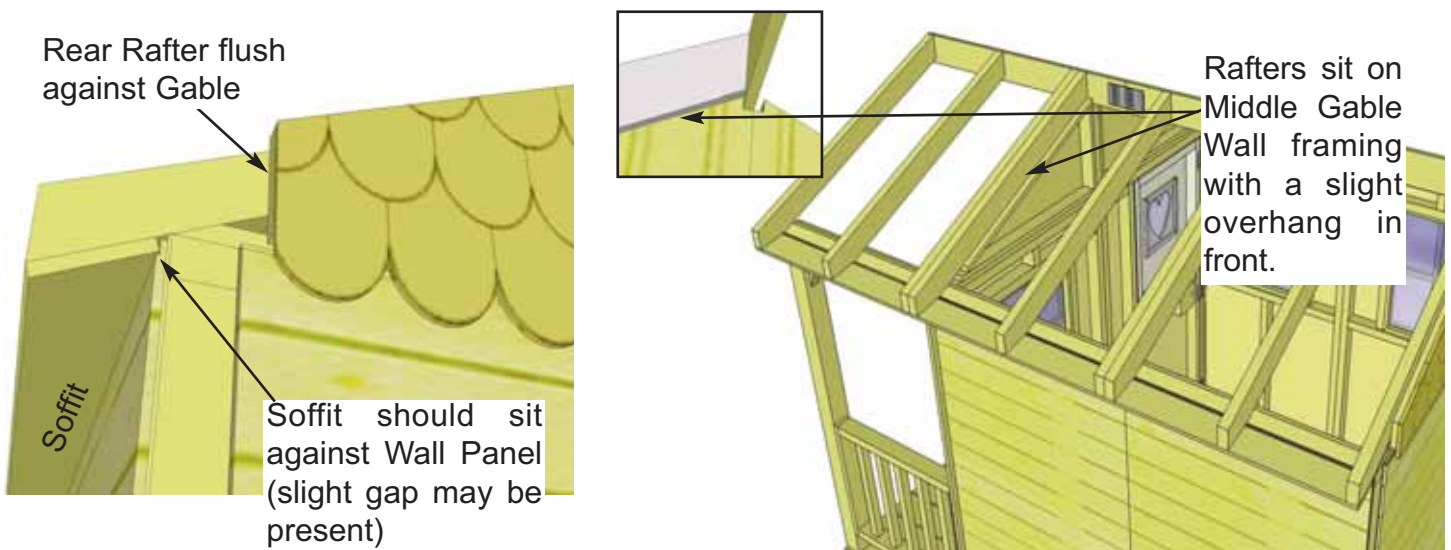

34. Position Rear Rafters flush against Rear Gable. On the Middle Gable, Rafter will slightly overhang siding of Middle Gable Wall.

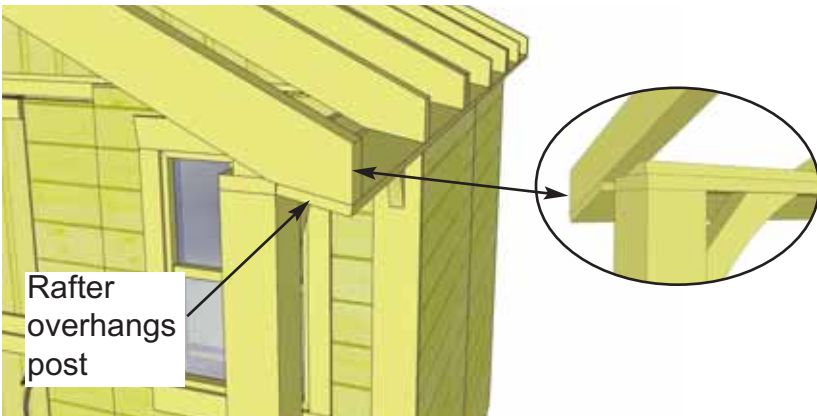

Rafter overhangs post

35. Rafter will overhang Porch Post when correctly positioned on walls.



36. Place second completed Rafter Section on Gable Walls and position as per **Steps 32 - 34.**

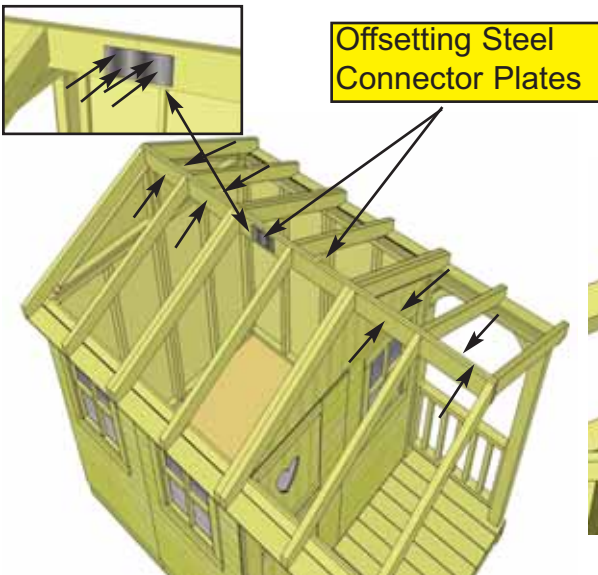

Offsetting Steel Connector Plates

To aid in securing Ridge Boards, place 4 - 1 1/4" screws into any of the remaining Metal Ridge Board Connector holes. Complete both sides.

37. At the peak, align Ridge Boards so they are flush together and secure them with 12 - 1 1/4" screws. **IMPORTANT:** If there is a gap between Ridge Boards, try pushing Side Walls closer together from outside. Walls should be 70" apart at top from inside of Wall Plate to Wall Plate.

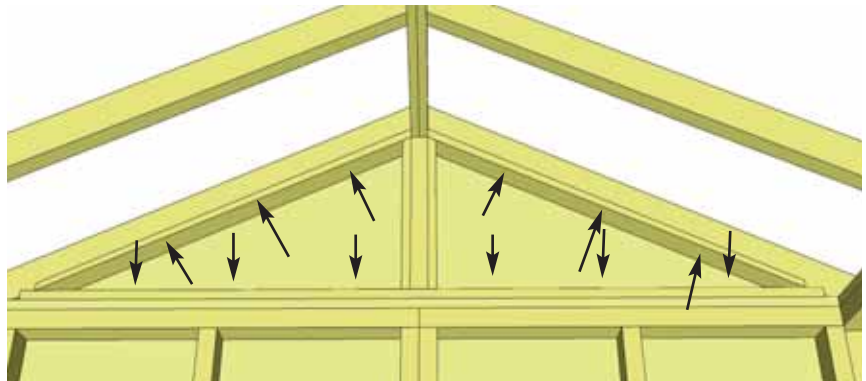

38. With both Rafter Ridge Boards connected, secure Gable Framing to both Outside Rafters and Top Wall Plates with 12 - 2" screws.

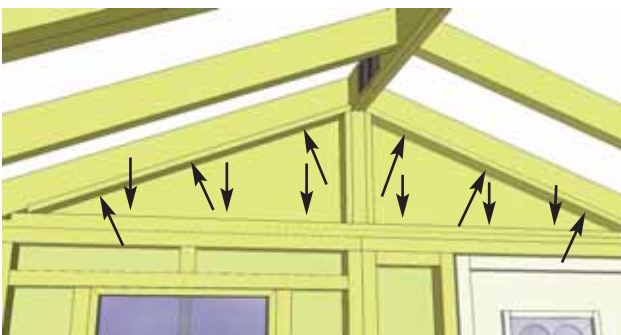

39. Secure Rafters to Middle Gable Wall framing and Top Wall Plates with 12 - 2" screws.

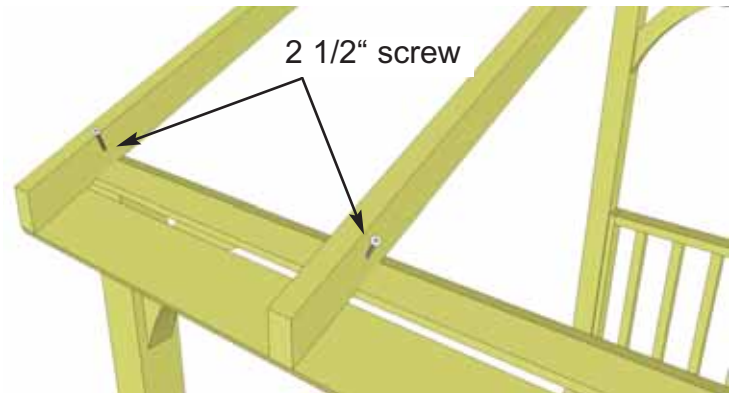

40. Attach Rafters in porch area into Top Plate of porch with 1 - 2 1/2" screw per Rafter. Once again, measure 70" from inside of wall plate to wall plate for correct Rafter alignment prior to attaching. **Drill pilot holes in rafters on angle first to prevent splitting and then screw down.**

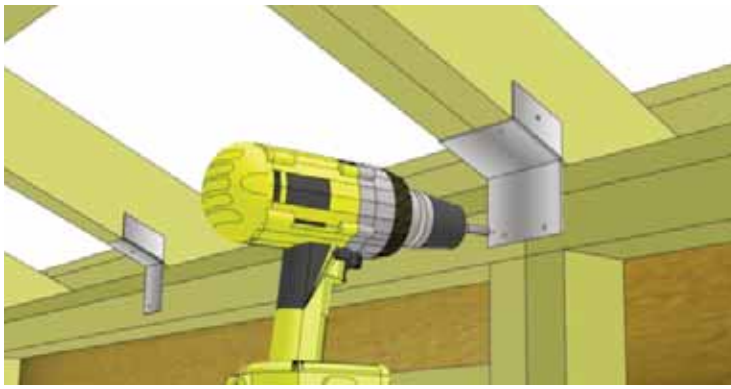

Shingles overhang plywood on outside panels

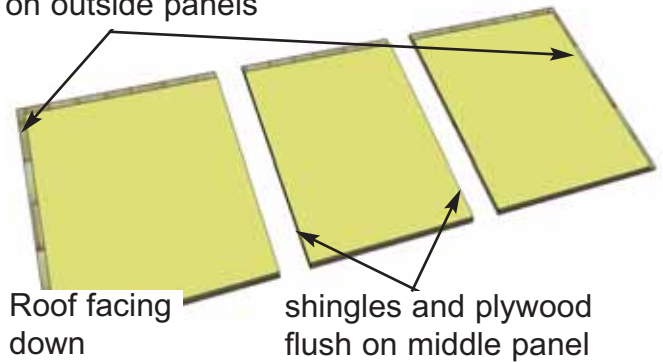

41. Attach all **Single** and **Double Rafter Brackets** where rafters meet Top Wall Plates inside of shed. Attach with 2 - 1 1/4" screws and 2 - 2" screws per Single Rafter Bracket and 6 - 2" screws per Double Rafter Bracket.

Prior to attaching, make sure walls are properly aligned. Have two helpers push the side walls at the top from the outside of shed until inside to inside measurement between side plates is 70".

42. Identify all **Roof Panels**. There are four **Outside** and two **Middle Roof Panels**. Outside Panels will have shingles overhanging the plywood on one end.

43. Lift up and place an Outside Roof Panel on Rafters. End of plywood on roof should be flush with end of rafter. Line up roof edge on seam of double rafter.

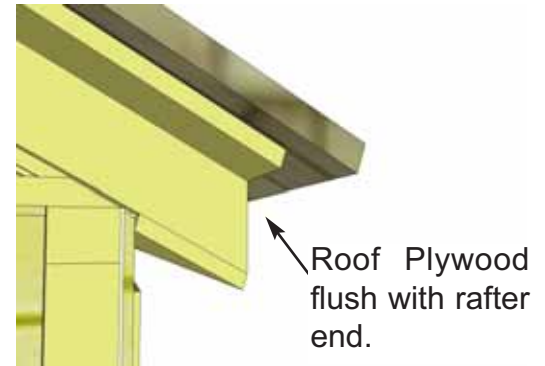

Roof Plywood flush with rafter end.

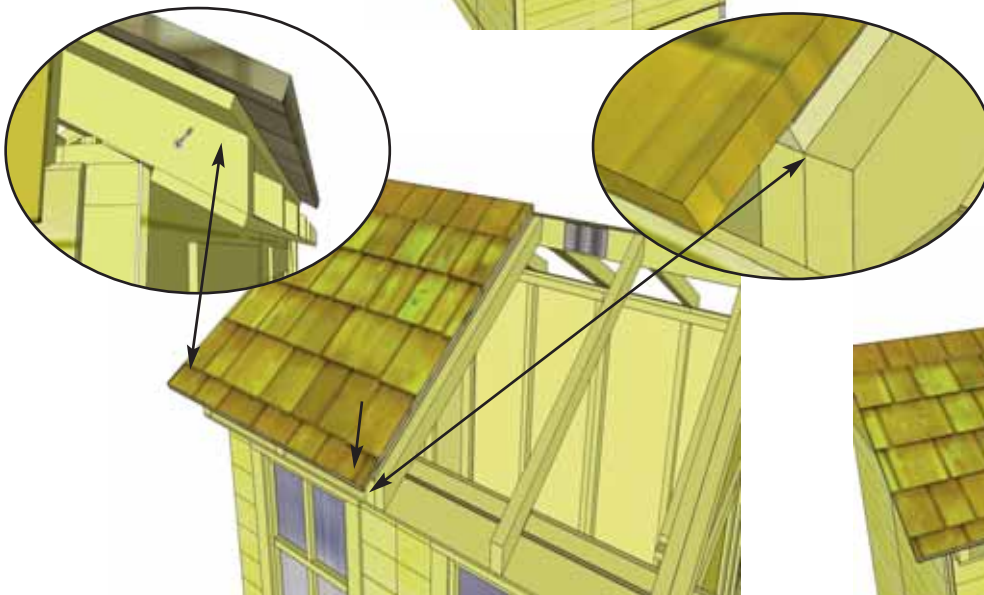

Middle Roof Panel

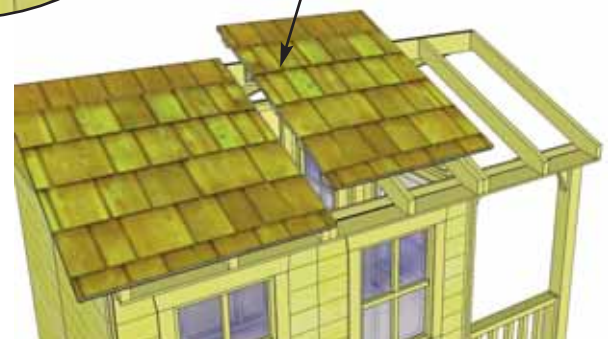

44. Place Outside Roof Panel so it sits flush on 3rd rafter from the outside (doubled up rafter). Plywood on roof should be flush with end of rafter at bottom. From the outside, screw down through bottom row of shingles into rafter with 1 - 2 1/2" screw. Angle a 2 1/2" screw from outside rafter into roof plywood. Locate **Middle Roof Panel** and position on Rafters.



45. To confirm, **Middle Roof Panel** will have roof plywood flush with outside of shingles. Place on Middle Rafters and align panel as per **Step 44**. Screw panel down to rafters with 2 - 2 1/2" screws in the bottom row of shingles.

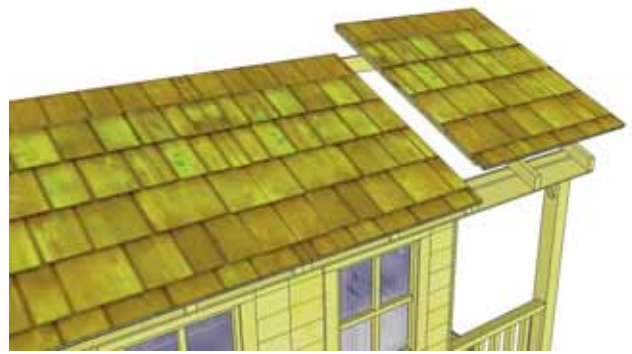

46. Lift up, position and attach **Front Outside Roof Panel** on Rafters as per **Step 42- 44**. Continue and place opposite **Rear Outside Roof Panel** on Rafters.

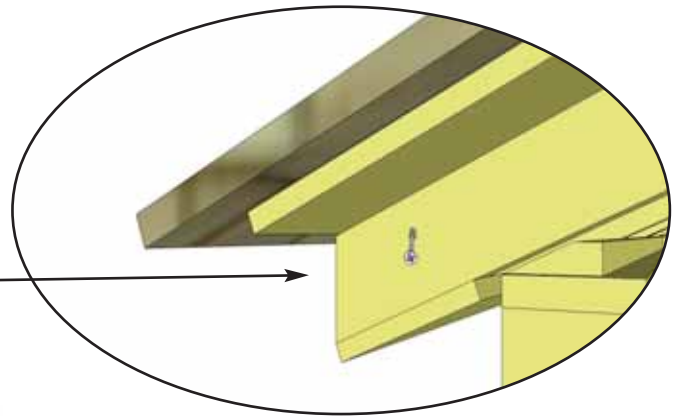
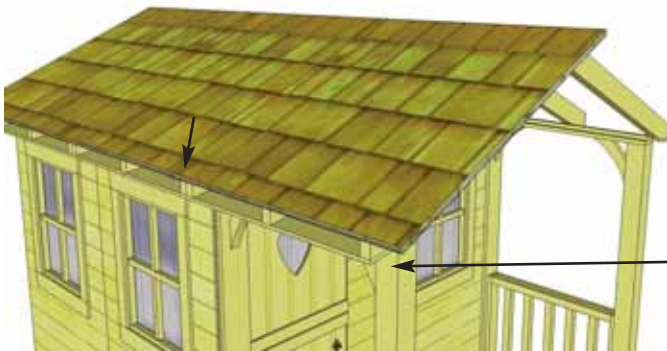

47. Position and attach all remaining Roof Panels as per **Steps 42-46**.

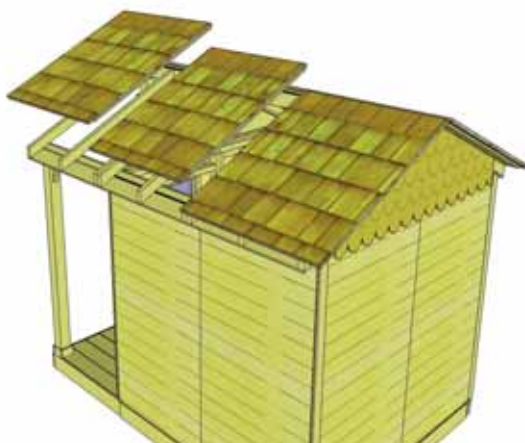



48. Roof **Filler Shingles** are included to cover roof seams. Starting at the bottom, slide the first Long Filler Shingle in until flush with other bottom shingles. **See step 49 for proper attachment.**



50. Slide in another Filler Shingle and attach as per **Step 49**. On your last row of shingles, the filler shingle is pre-cut to fit properly. Attach to roof with 2 finishing nails per shingle.

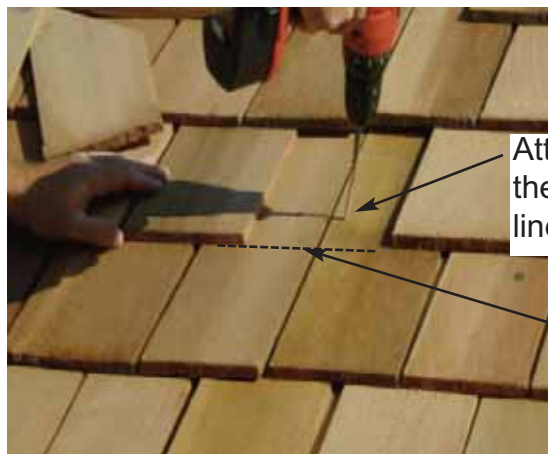

49. Screw first filler shingle down to rafters using 1 - 2 1/2" screw per panel (2 in total). Make sure to screw into both rafters.

Attach above the exposure line.
Exposure Line

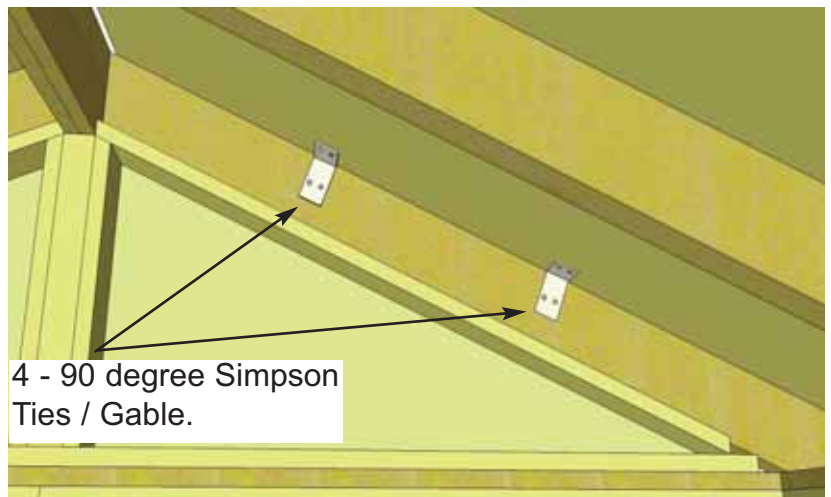

4 - 90 degree Simpson Ties / Gable.

51. Position Simpson Strong ties on plywood and outside rafters of back gable and secure with 4 - 1 1/4" screws. There are 4 ties in total.

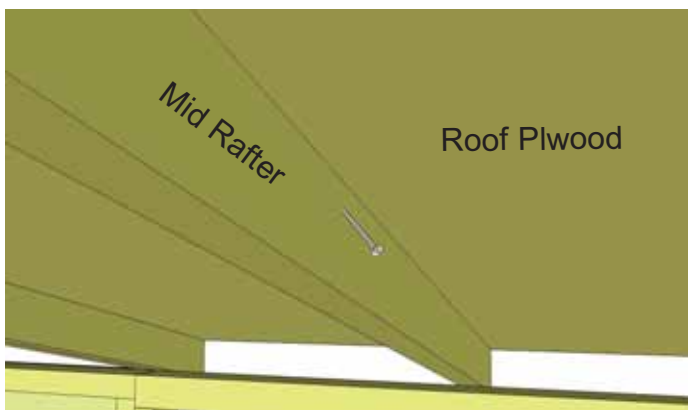

Mid Rafter

Roof Plywood

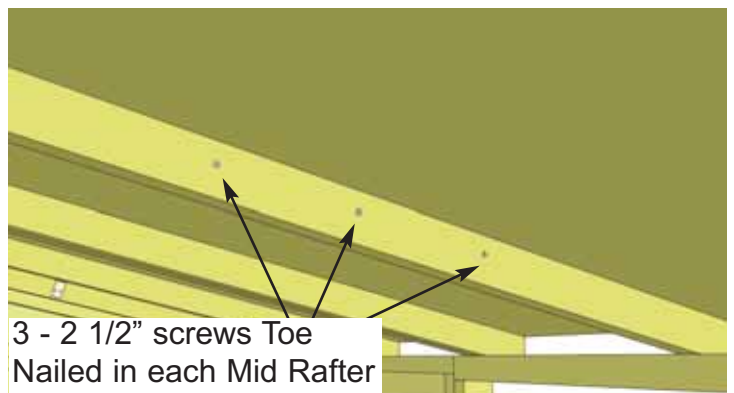

3 - 2 1/2" screws Toe Nailed in each Mid Rafter

52. To further secure roof panels, from the inside, drill pilot holes in each Mid Rafter (3 per Rafter) on an angle. Using 3 - 2 1/2" screws, secure rafters to roof plywood. **Note:** from outside, have a helper push roof panel down so plywood sits flush against rafter when securing. In Porch area, angle screw both the mid and outside rafters.

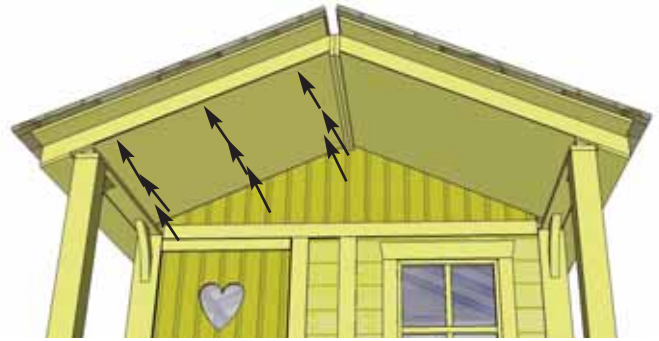

53. Position Porch Veneer with best face exposed, flush with front Rafter and Ridge Board. When correctly in place, nail veneer to rafters with 12 finishing nails. Complete both sides.



54. Attaching the **Decorative Front Gable** is next. Place the Decorative Front Gable underneath porch roof, tight against roof rafter. Be sure to center gable evenly from side to side and place tight up to roof plywood.

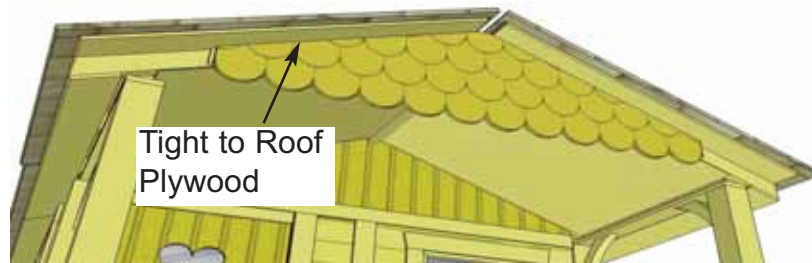

55. With Decorative Gable correctly positioned, fasten to rafters with 4 - 2" screws (2 per side). Drill 1/8" pilot holes first to avoid splitting the decorative shingles.

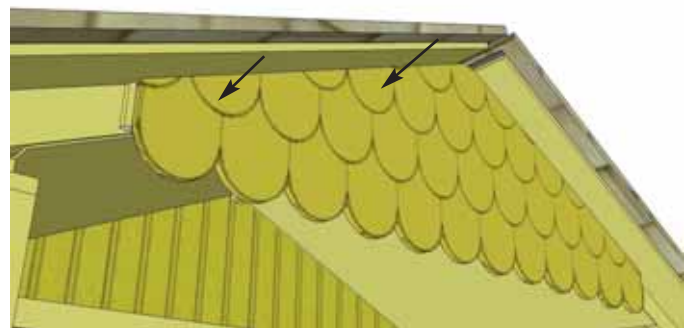

D. Porch Section

56. To complete your porch, attach **Front Porch Rail Section** to **Short Deck Post** and position on Deck. Screw completed Front Porch Section to Porch Post with 3 - 2" screws. Use Rail Support Block (**See Step 58.**) to determine correct rail height.

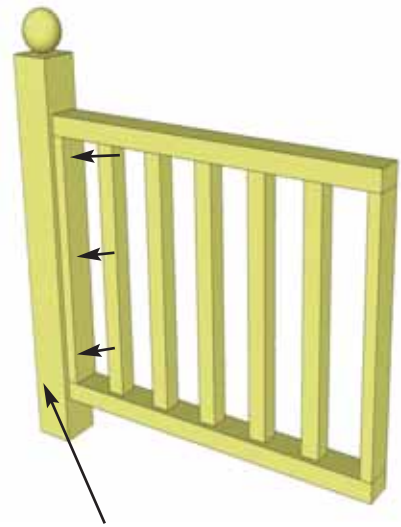
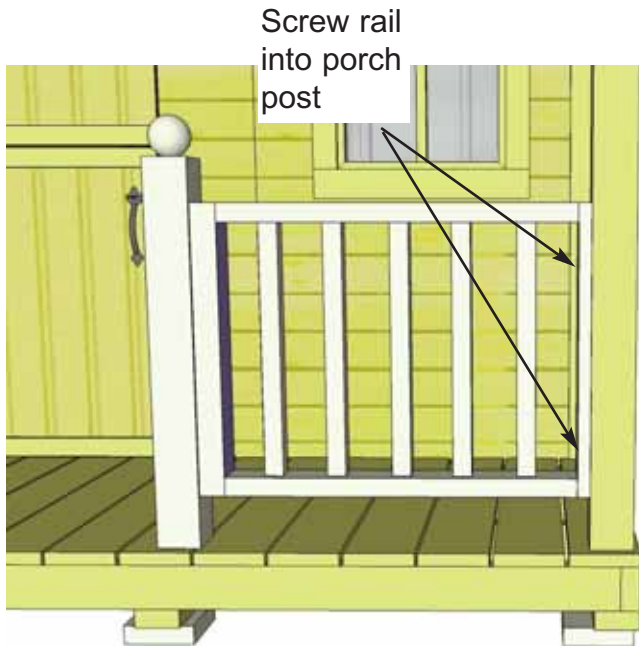

Use Rail Support Block (3 1/2" high) from bottom of post to align rail. Attach rail to post with 3 - 2" screws.

57. Toe-nail or angle screw all Porch Posts to floor with 3 - 2 1/2 screws per post. Drill pilot holes to avoid splitting posts. Position Screws so Post Base Trims in **Step 58** will cover. Confirm Porch Post alignment as per **Step 25** prior to attaching.

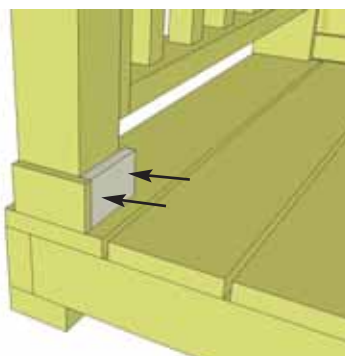
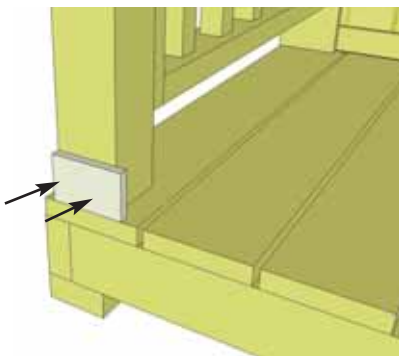
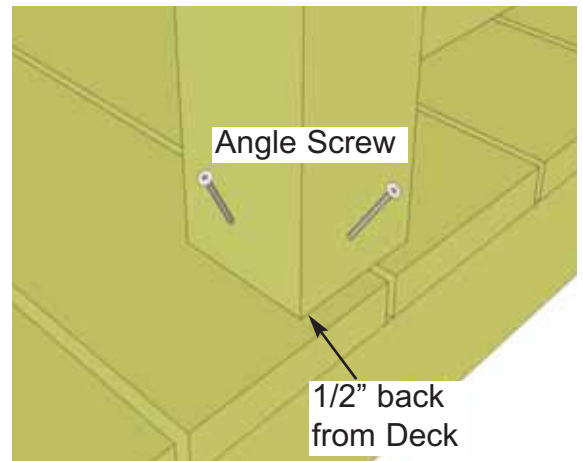

58. Attach **Post Base Trims** to bottom of Porch Posts. Attach with 1 1/2" finishing nails. Center a **Rail Support Block** (1 1/2" x 3 1/2" x 3 1/2") under each Handrail Section and secure from top down with 2 - 2 1/2" screws. Complete each Handrail Section.

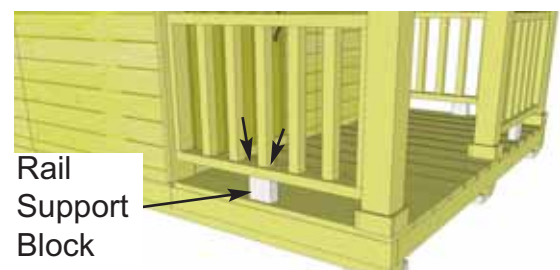

E. Miscellaneous Section

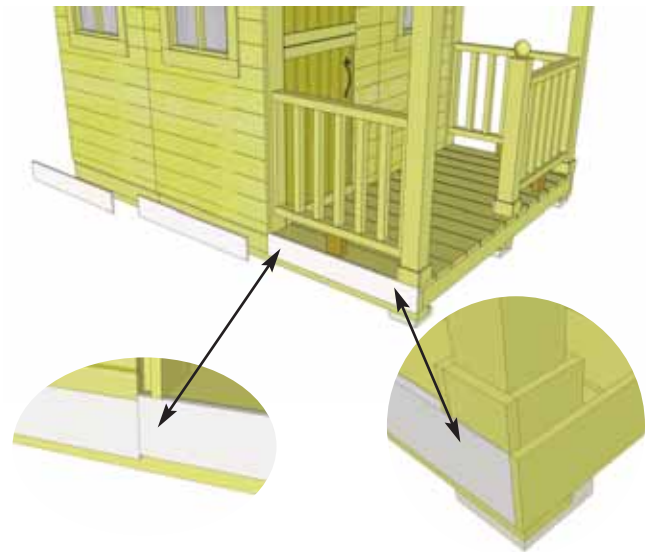
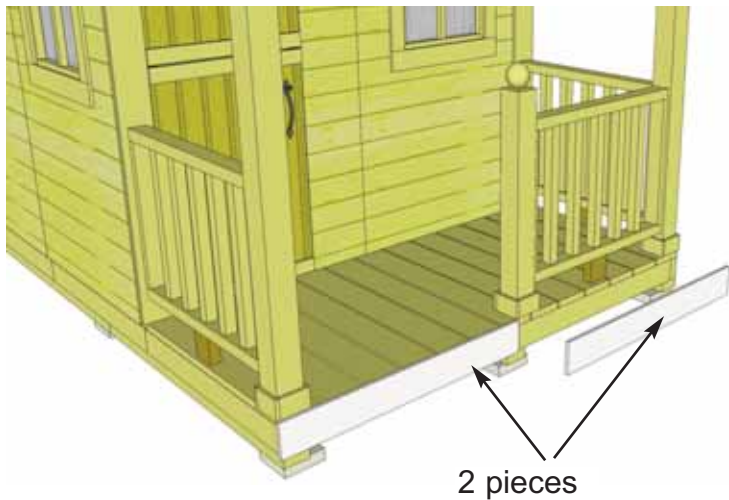
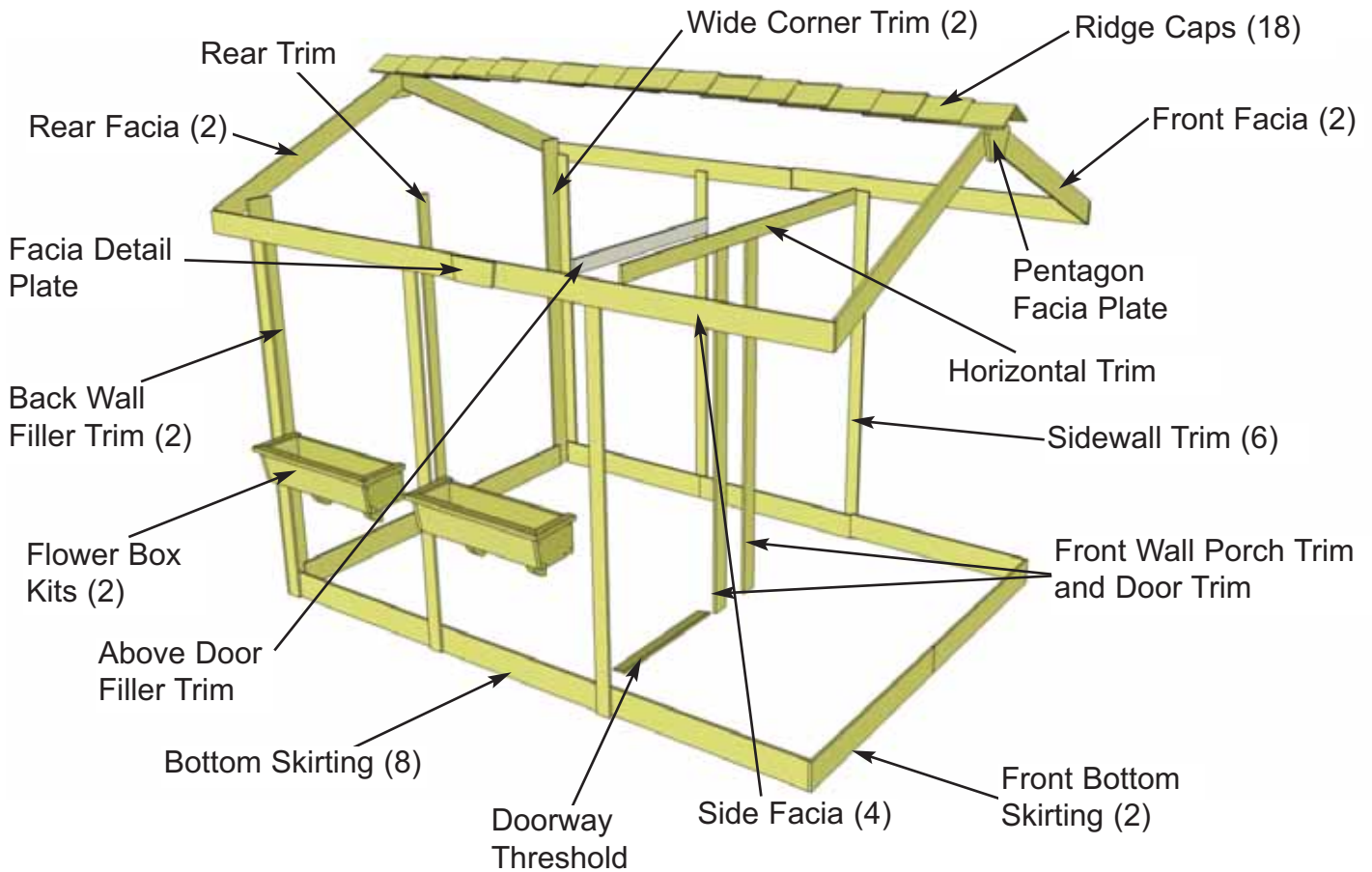

59. Attach **Bottom Skirting** around the base of the playhouse. There are two Front Skirting pieces that are 38" long that will overlap the Side Skirting. There are eight remaining Bottom Skirting pieces that are 35" long. Attach with 4 - 1 1/2" finishing nails per piece. Gaps will appear in the rear corners but will be covered by trim later.

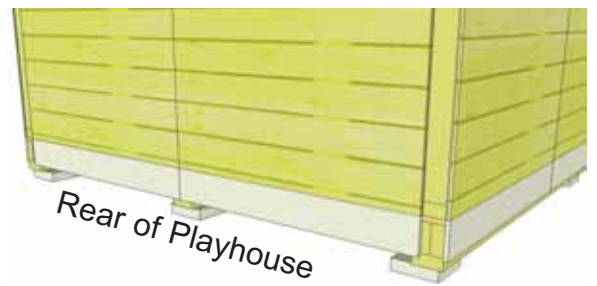

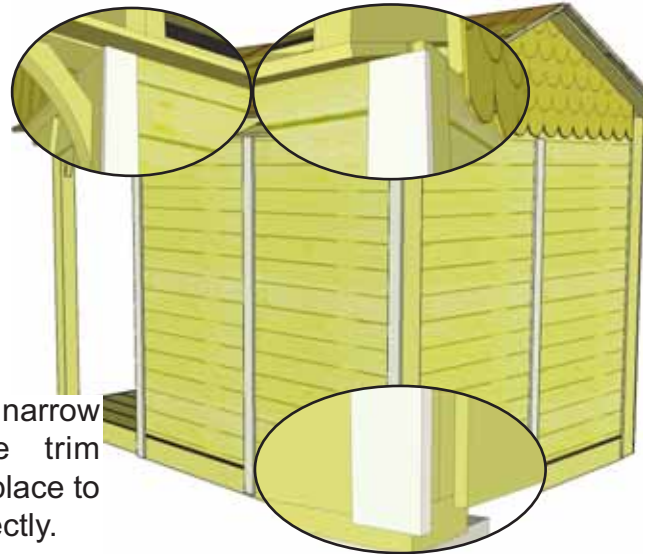
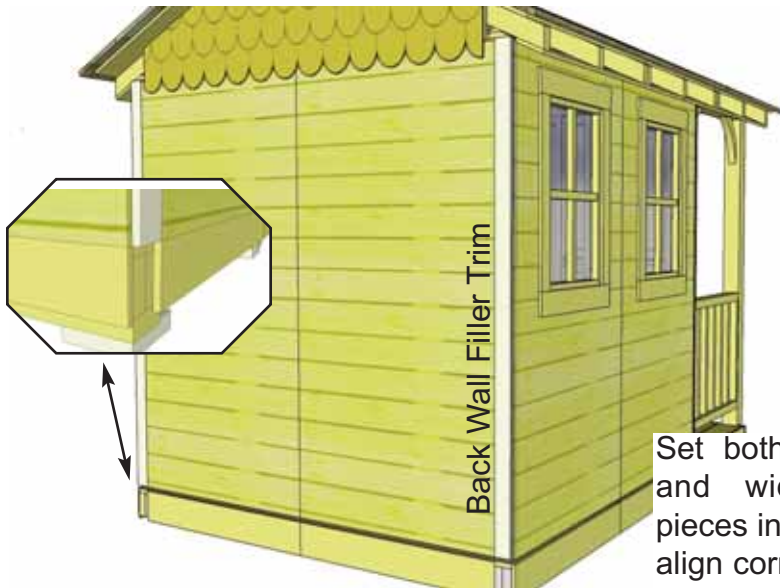

Set both narrow and wide trim pieces in place to align correctly.

60. Attach two 5/8" x 2 1/2" x 60" **Back Wall Filler Trims** to back wall corners. Hammer with 6 - 1 1/2" finishing nails. Flush trim with skirting and siding.

61. Align and attach both **Rear and Sidewall Trims** (7 @ 1/2" x 2 1/2" x 64") on each wall seam and in each corner. Position tight underneath Soffit and Rafter. Narrow Trims will cap Wide Corner Trims in Rear and side of Porch. See **Step 62** for detail. Use 6 - 1 1/2" finishing nails to secure each piece. Note that Narrow Trim will sit slightly below Bottom Skirting when correctly attached. Do a dry run with both Narrow and Wide Trims prior to attaching to confirm positioning.



62. Attach **Back Wall Wide Corner Trims** (4 1/2" wide) tight to Narrow Trim and flush at bottom. Use 6 - 1 1/2" finishing nails to secure. Complete both sides.

63. Attach **Facia/Roof Nailing Strips** to the underside edge of the plywood roof. Center and attach with 3 - 1 1/4" screws. Complete all four sides.

Attach **Front and Rear Facia** (angle cut on ends) to end of roof panel plywood and nailing strip with 5 - 1 1/2" finishing nails per piece. Line up Rear Facia evenly with Rafter ends. Use Side Facia to confirm positioning.

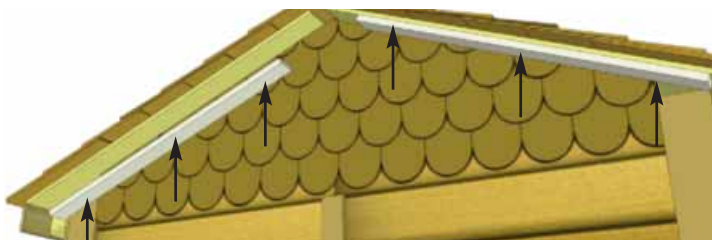
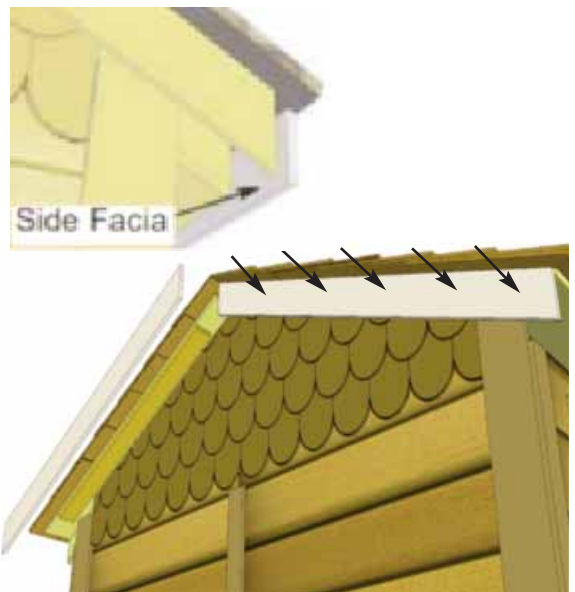

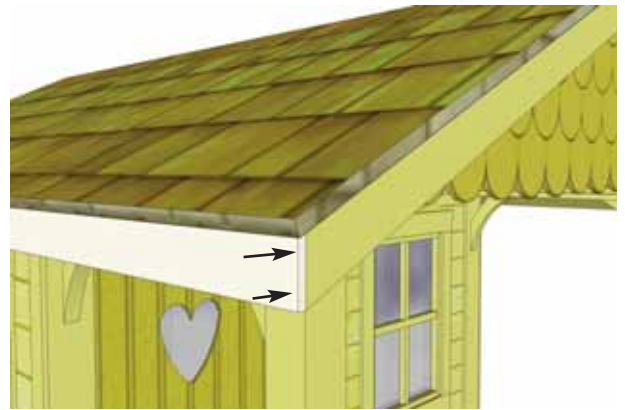

64. Attach **Side Facia** to Roof Rafter Ends. There are two Side Facia pieces per side. Secure with 8 - 1 1/2" finishing Nails per piece.

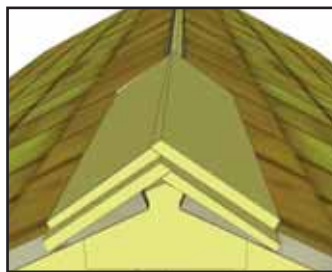
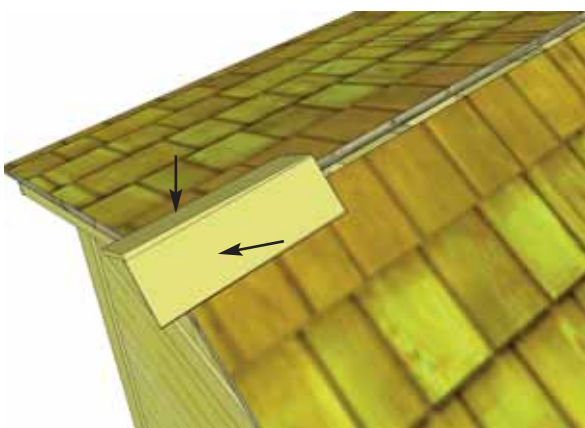

Important - Butt (thick) end of Ridge Cap will be facing towards the outside of shed.

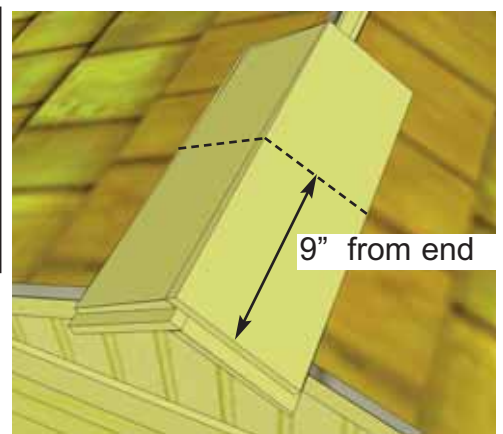

65. Place First Roof Ridge Cap on roof peak overhanging shingles by approximately 2". Attach with 2 - 1 1/2" Shingle Nails 9" from end. Place 2nd Ridge Cap 1" back from 1st cap. Attach with 2 - 1 1/2" Shingle Nails 9" from end.

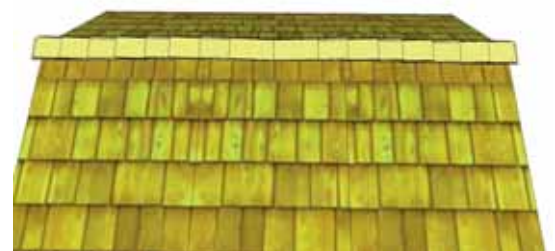
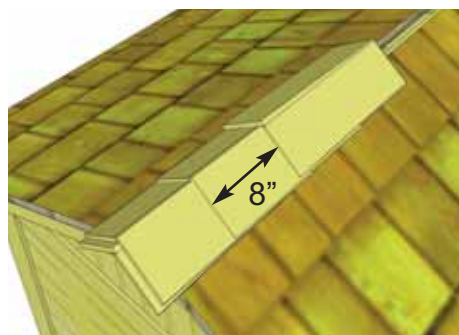
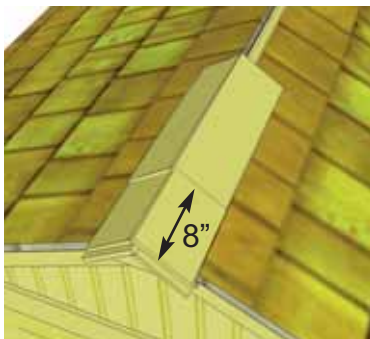

66. Place 3rd Ridge Cap 8" back from 2nd (enough to cover shingle nails). Attach 3rd Ridge Cap down as per **Step 65**. Continue to position and attach Ridge Caps until half the roof is complete. From opposite side, position and attach Ridge Caps as described above. Score/cut 1 Ridge Cap to 12" or to fit in the center of roof. Attach center cap with 4 - 1 1/2" Shingle Nails.

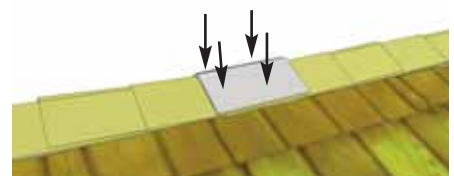

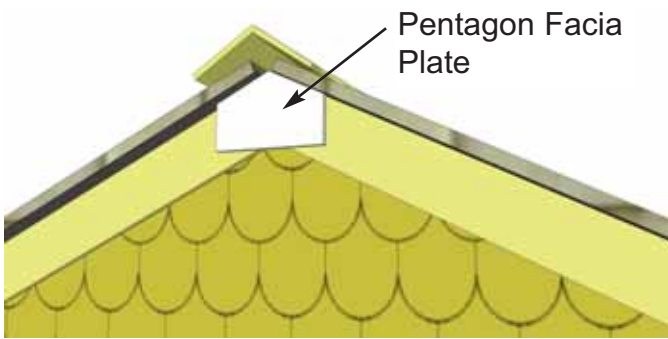

67. Attach **Pentagon Facia Plate** to Rear and Front Facia with 4 - 1 1/2" finishing nails. Facia Plate will cover any gaps existing where Facia's come together at peak. Attach **Facia Detail Plates** (2) where Side Trims meet. Use 4 - 1 1/2" finishing nails to secure.

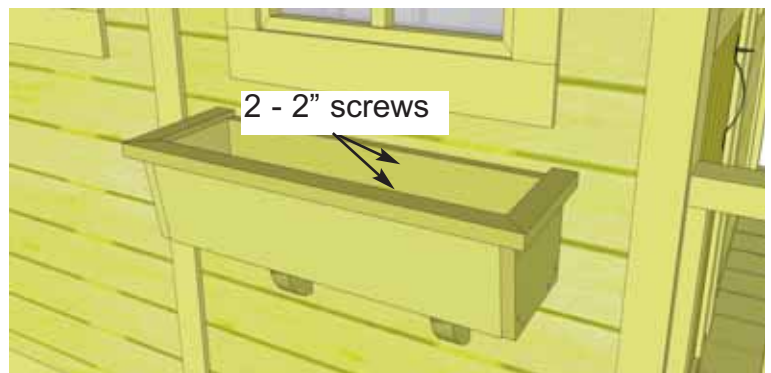
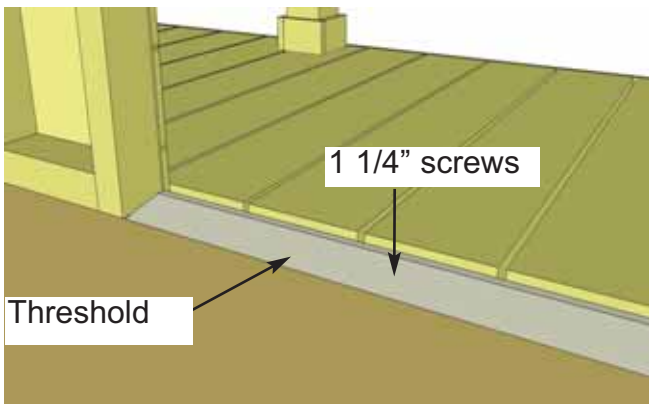

68. Also included is an optional **Doorway Threshold** piece that is 23" long and angle cut. Attach where Plywood Floor and Decking meet under the door with 3 - 1 1/4" screws.

69. Assemble **Flower Box Kit**. Assembly Instructions are found on Page 28. Position completed Flower Box below bottom of window trim and secure with 2 - 2" screws per box. Screw from inside of box into the center wall stud. Attach second screw 2" underneath first screw and once again into the wall stud. Install Flower Box Kits underneath each window.

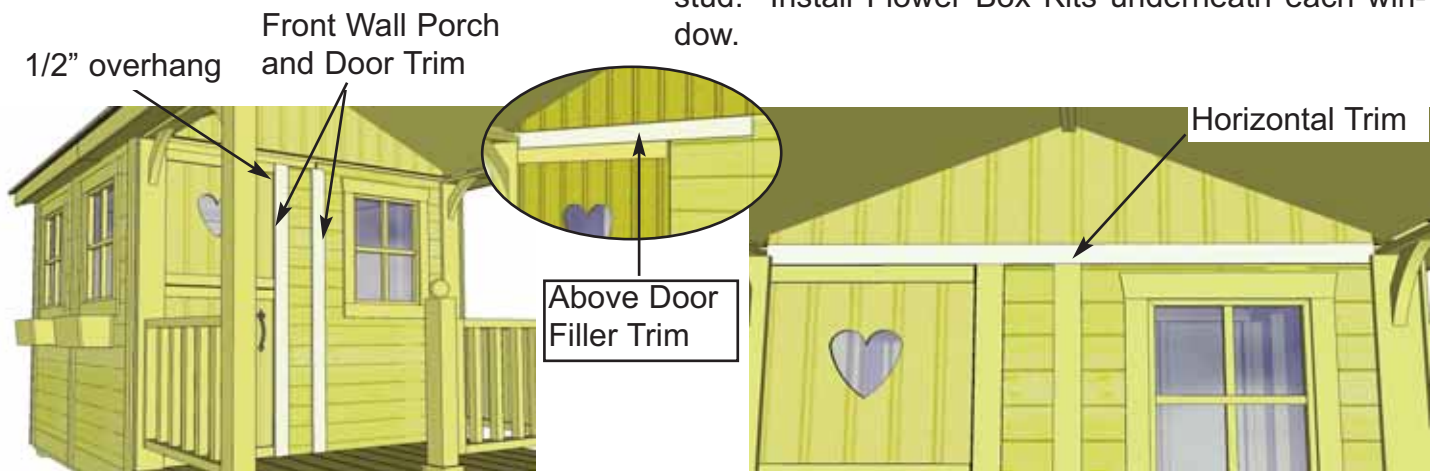

70. Finally, to finish your Playhouse, attach the **Above Door Filler Trim**, **Front Wall Porch Trim** and **Door Trim** (58" long vertically). Attach Filler Trim to Door Header with 3 - 1 1/2" nails. The Front Wall Porch Trim will cover wall seam. The Door Trim will overhang doorway by 1/2" and also act as a door stop. Attach both with 6 - 1 1/2" finishing nails per piece. Finally, attach the **Horizontal Trim** (67" long) above the Door and window flush to the top of the Porch Trim. Use 6 - 1 1/2" Finishing Nails to secure into the Gable.

Outdoor Living Today Flower Box Assembly Instructions

Parts Lists:

A - Base, Rear & Front Box Frames	(3pcs)	3/4" x 5 1/2" x 23"
B - End Cap Frames	(2pcs)	3/4" x 5 1/2" x 7" / 8"
C - Front Trim	(1 pc)	3/4" x 1 1/2" x 26"
D - Side Trims	(2 pc)	3/4" x 1 1/2" x 8 3/4"
E - Brackets	(2 pc)	1 1/2" x 5 1/2" x 5 1/2"
F - 1 1/4" Screws		
G - 1 1/4" Nails		

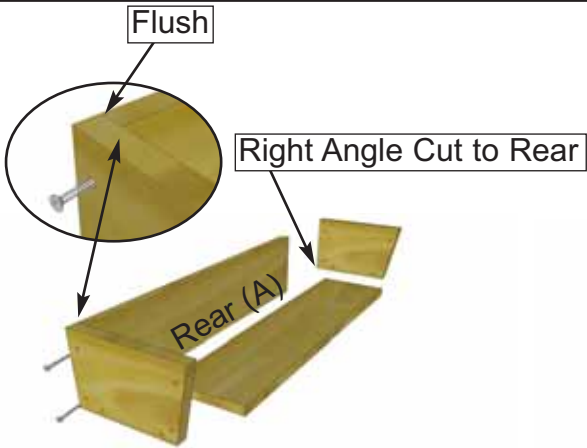
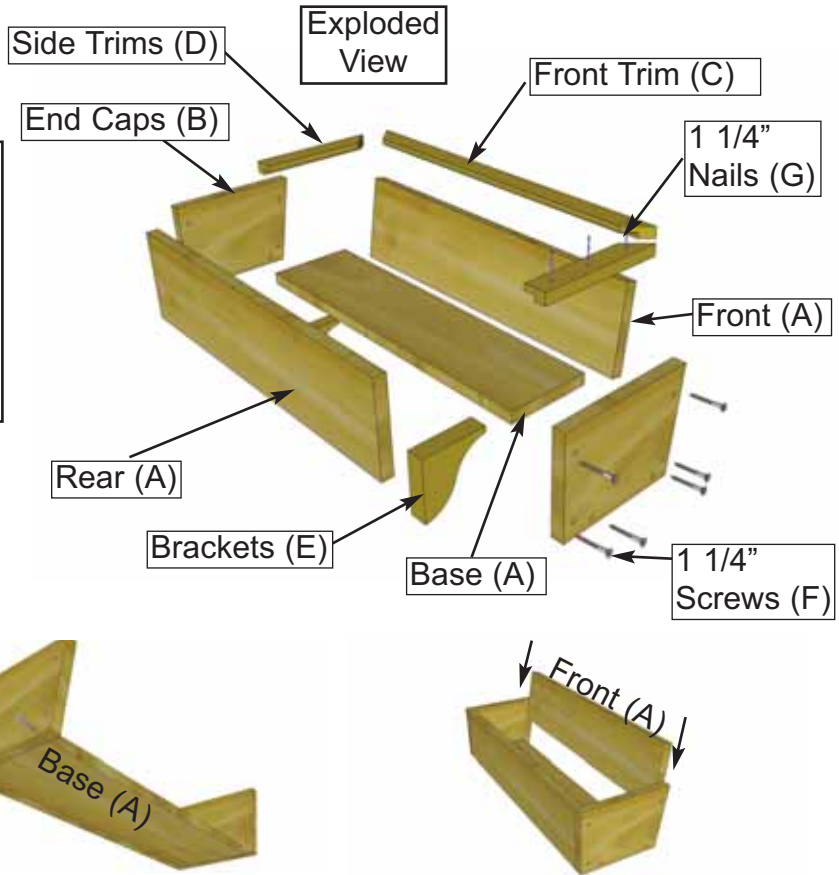

1. On a table position Rear Box and End Cap Frames together so flush at top. Fasten together with 2 - 1 1/4" screws. Place Base Frame tight against Rear and End Cap and flush at bottom. Secure with 2 - 1 1/4" screws. Complete attachment of remaining End Cap Frame. Slide Front Frame between End Caps.

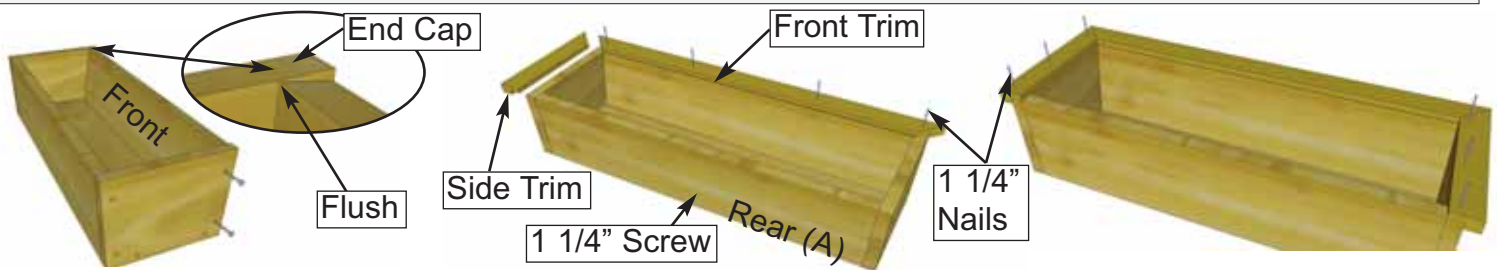

2. Position Front Frame Piece flush with End Cap. Attach both ends with 2 - 1 1/4" screws. Pilot hole Rear Box Frame near bottom center and secure to Base edge with 1 - 1 1/4" screw. Evenly position Front Trim (mitre cut on end and dado cut on inside bottom) tight against front frame and nail down with 4 - 1 1/4" nails. Position Side Trims as per Front and secure with 3 - 1 1/4" nails per side.

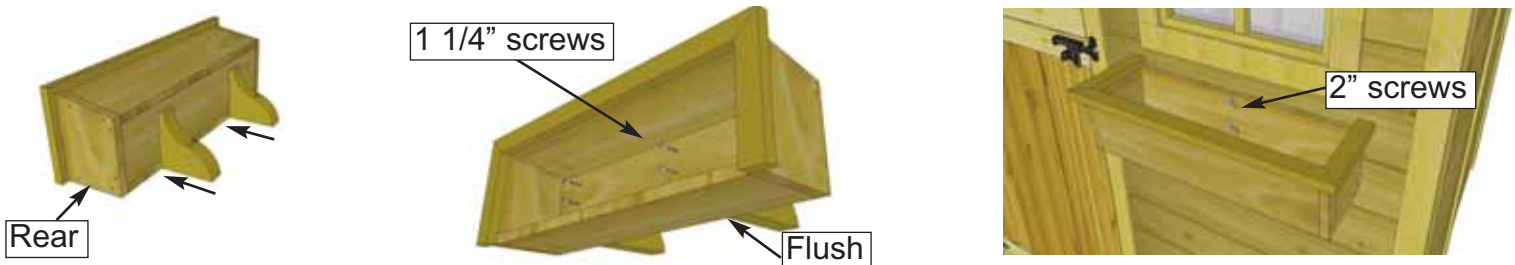

3. On a flat surface, flip Flower Box on it's rear face. Evenly space Brackets and secure through Base Frame and into the Brackets with 2 - 1 1/4" screws per Bracket. Position completed Flower Box beneath window trim and screw from inside of box into the center wall stud with 2 - 2" screws. (2" screws supplied with Base Kit.)



Congratulations on completing your 6x9 Sunflower Playhouse!



We hope your experience assembling your 6x9 Sunflower Playhouse has been both positive and rewarding.

Note: Our Sheds are shipped as unfinished products. If exposed to the elements, the western red cedar lumber will weather to a silvery-gray color. If you prefer to keep the cedar lumber looking closer to the original color, we suggest that you treat the wood with a good oil base wood stain. You may also wish to paint your new shed rather than stain it. In both cases we recommend that you consult with a paint and stain dealer in your area for their recommendations.

We value your feedback and would like to hear back from you on how well we are doing in the following areas:

1. **Customer Service**
2. **On Time Shipping**
3. **Motor Freight Delivery**
4. **Quality of Materials**
5. **Assembly Manual**
6. **Overall Satisfaction.**

Please call, write or email us at:

Outdoor Living Today

Canadian Address
9393 287th Street
Maple Ridge, British Columbia
Canada V2W 1L1

United States Address
P.O. Box 96
Sumas, Washington
USA 98295



The materials contained in this Assembly Manual may be downloaded or copied provided that ALL copies retain the copyright and any other proprietary notices contained on the materials. No material may be modified, edited or taken out of context such that its use creates a false or misleading statement or impression as to the positions, statements or actions.