

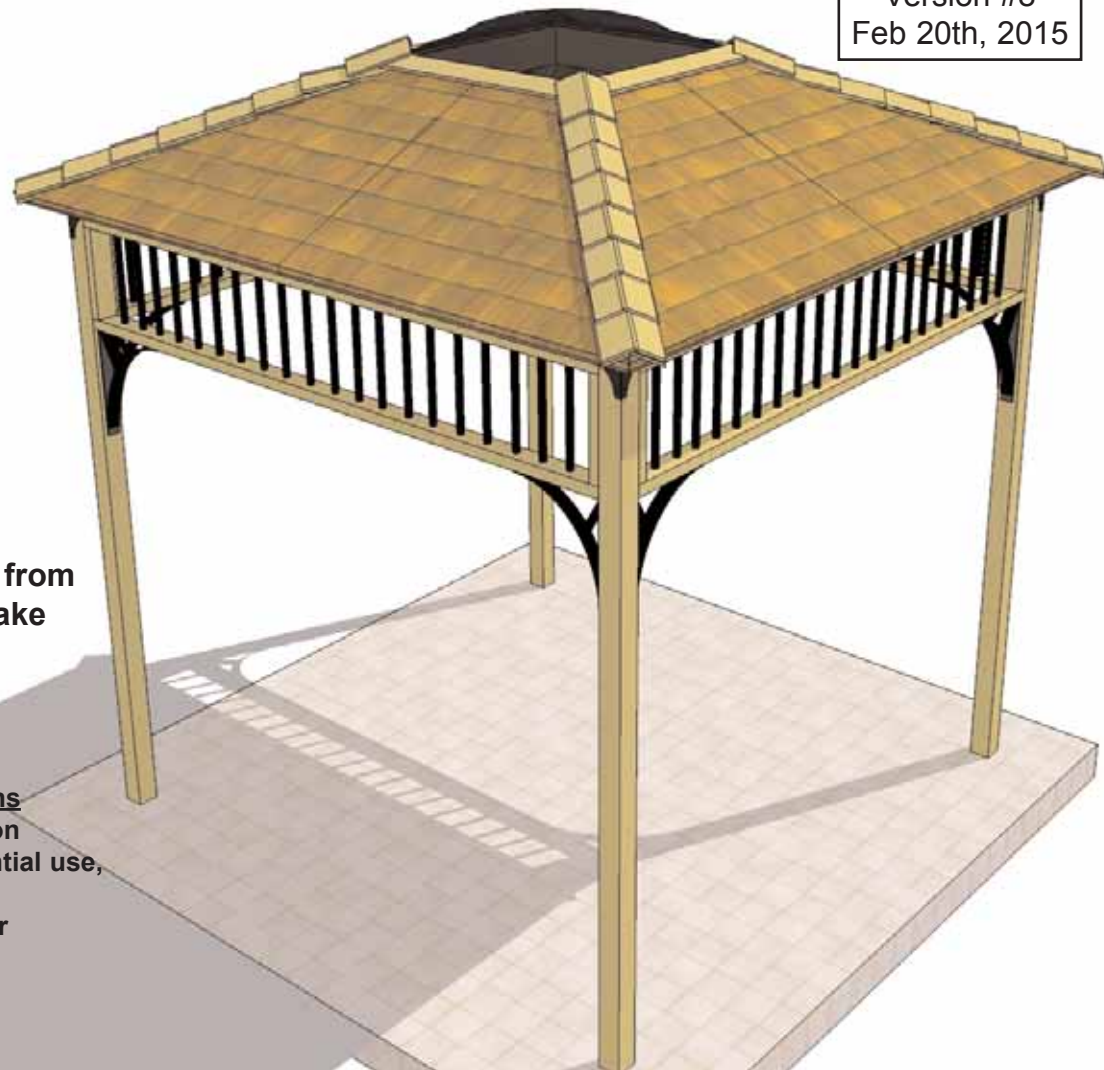

9 ft Naramata Spa Shelter Assembly Manual Outdoor Living Today

Version #8
Feb 20th, 2015



Thank you for purchasing a Naramata /Getaway Spa Shelter from Outdoor Living Today. Please take the time to identify all the parts prior to assembly.

Safety Points and Other Considerations

Our products are built for use based on proper installation and normal residential use, on level ground. Please follow the instruction manual when building your shelter and retain the manual for future maintenance purposes.

- Some of the safety and usage measures you may wish to consider include:
- snow load ratings vary by geographical location. If heavy or wet snowfall occurs, it is advisable to sweep the snow off the roof(s).
 - if the product is elevated, any structural and building code requirements are solely the customer's responsibility, and should be abided by.
 - in high or gusty wind conditions it is advisable to keep the structure securely grounded.
 - have a regular maintenance plan to ensure screws, doors, windows and parts are tight.

Customers agree to hold Outdoor Living Today and any Authorized Dealers free of any liability for improper installation, maintenance and repair of any Outdoor Living Today products.

In the event of a missing or broken piece, simply call the Outdoor Living Today Customer Support Line @ 1-888-658-1658 within 30 days of the delivery of your purchase. It is our commitment to you to courier replacement parts, free of charge, within 10 business days of this notification. Replacement parts will not be provided free of charge after the 30 day grace period.

Thank you for purchasing one of our Naramata Spa Shelters.
Please take the time to identify all the parts prior to assembly.

Parts Lists:

A. Wall Section

- 4 - 3 1/2" x 3 1/2" x 92" long Posts
- 4 - Upper Railing Sections 13"h x 101"long (Getaway = 10"high- wood)
- 8 - 1 1/2" x 3 1/2" x 54" Top Plates (cut on 45 degree on 1 end)

B. Roof Section

- 1 - Skybox - 5 1/2" high x 37" x 37"
- 4 - 1 1/2" x 3 1/2" Corner Rafters with Side Cleats- 58 3/8" long
- 4 - 1 1/2" x 3 1/2" Center Rafters with Side Cleats - 42" long
- 8 - 1 1/2" x 3 1/2" Mid Rafters (without Side Cleats) - 42" long
- 4 - Left Side Roof Sections
- 4 - Right Side Roof Sections
- 1 - Bundle of Filler Shingles (16" long & 4 Top Row Trimmed)
- 32 -Regular Cedar Roof Ridge Caps
- 4 - 10" long Cedar Roof Ridge Caps with Roofing Paper attached
- 4- 42" long x 3" wide Flex Flashings for Skylight
- 4 - 1/2" x 3 1/2" x 36" long Skylight Trims

Assembly Time:

1 Day (does not include site preparation)

Specifications:

Outside Post to Post Dimensions

108" w x 108" w

Inside Post to Post Dimensions

101" w x 101" w

Overall Dimensions with Roof Overhang

120" w x 120" w x 116" h

Overall Weight

750 Lbs

9'x9' NARAMATA HARDWARE SHEET

Hardware Kit (Provided)

Note: screws and nails shown actual size.

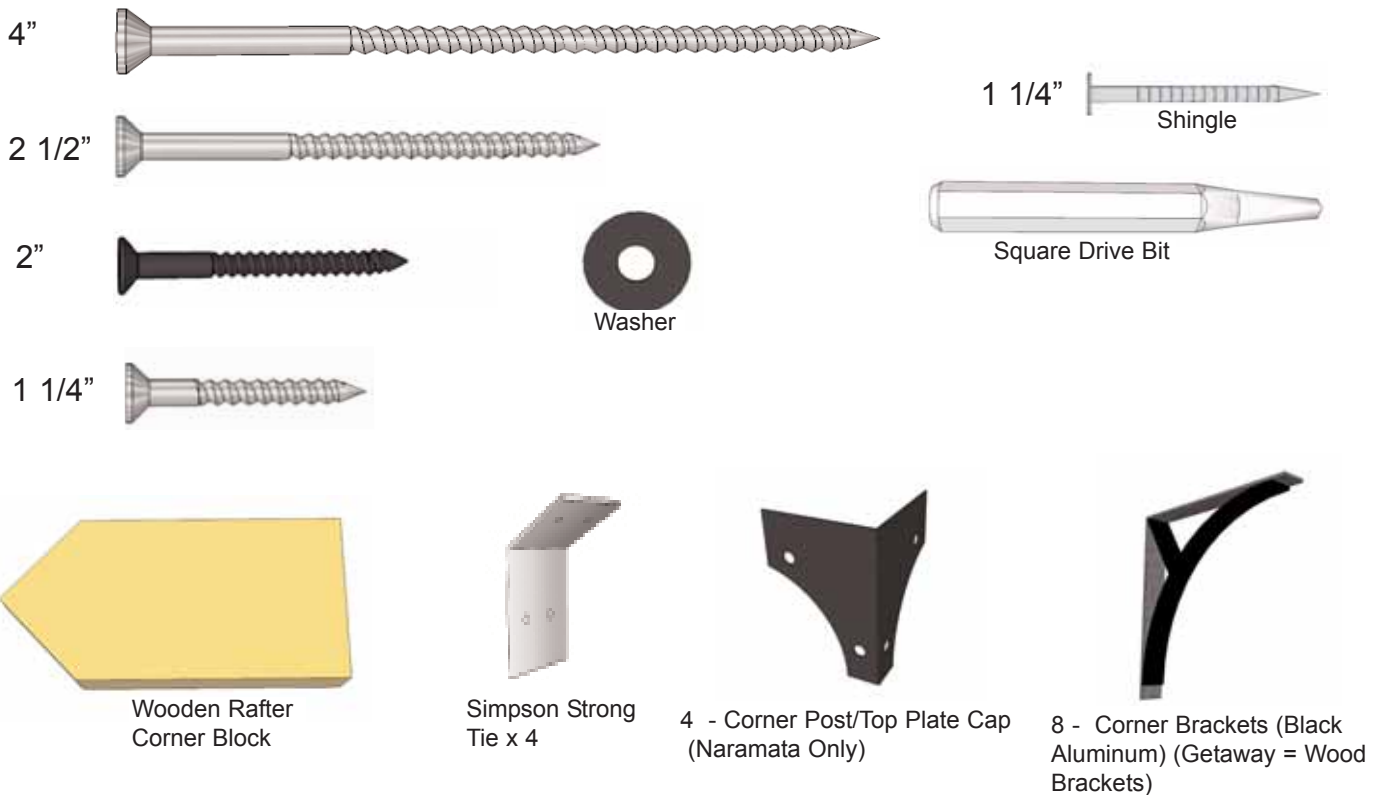

Tools Required (Not Provided)



Hammer



Screw Gun/Drill



Tape Measure



Wood Clamp



Utility Knife



Level



Pliers



Ladder



Stapler



1/8" Drill Bit

Safety Equipment Required (Not Provided)



Safety Glasses



Work Gloves

Important - Assembly Manual shows illustrations for Naramata Model. Please follow general assembly instructions for Naramata. Refer to Parts List for any differences between Models.

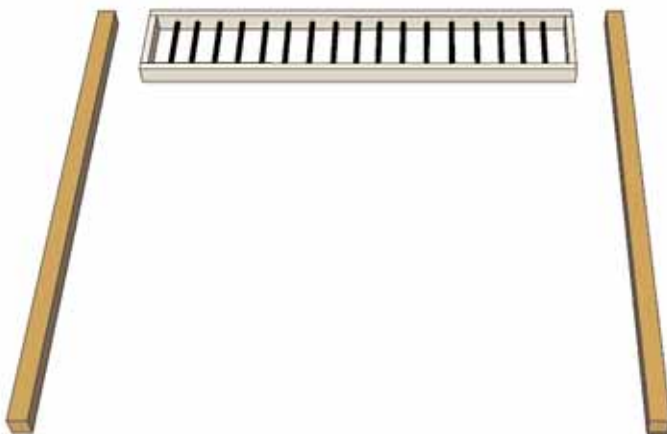

1. On a flat level surface, position 2 - 4x4 Posts and 1 Upper Baluster Section together as shown above.

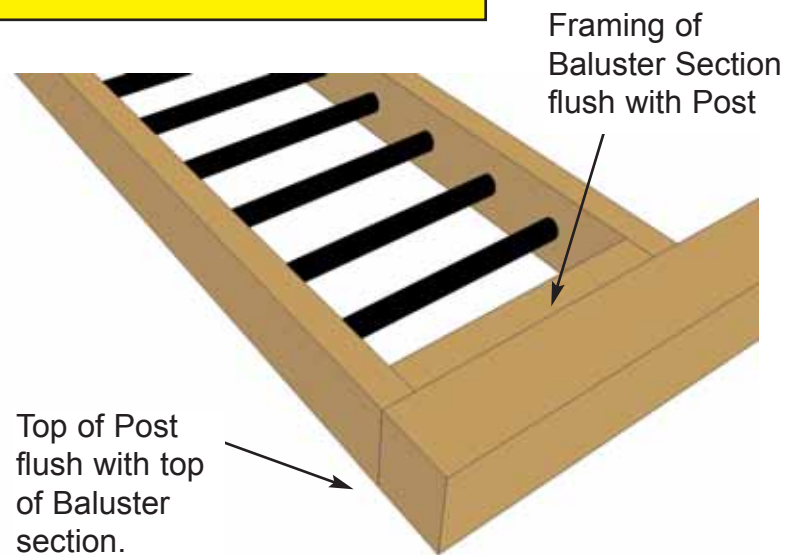

2. Place both Posts and the Upper Baluster Section flush with each other.

3. When Post and Baluster Section are position correctly, fasten together with 4 - 2 1/2" screws per side.

Hint- screw both front sides (2 screws per side) flip assembly over and complete the other sides.

2 1/2" screws here.

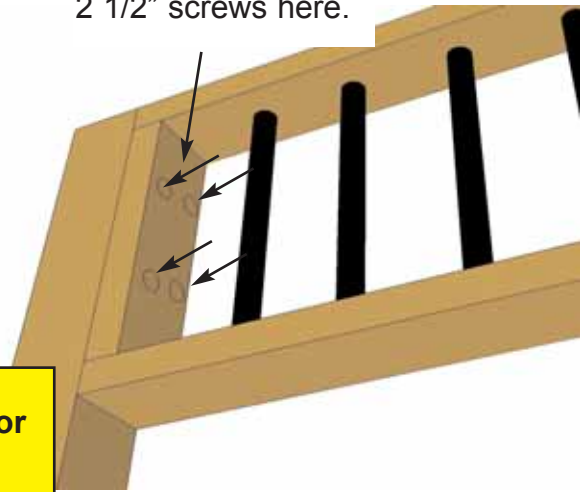

You can find the Square Drive Bit for the screws in with the Hardware Kit Bag.



4. Complete 2nd Post/Upper Baluster Attachments.

5. Standing the Post/Baluster Assemblies will be easier with 2 extra helpers. Carefully raise one of the section up first and steady with 1 helper. Raise the second assembly up and steady with your other helper.



Place assemblies approx. 9 feet apart.

6. While both sections are held in place by your helpers, locate a 3rd Upper Baluster Section and place between both sections. Have your helper stand close to your end to assist you with the lifting of the Baluster Section while still keeping the assembly steadied.





7. Place the 3rd Upper Baluster Section into place so both post and framing are flush with each other as per **Step 2**.

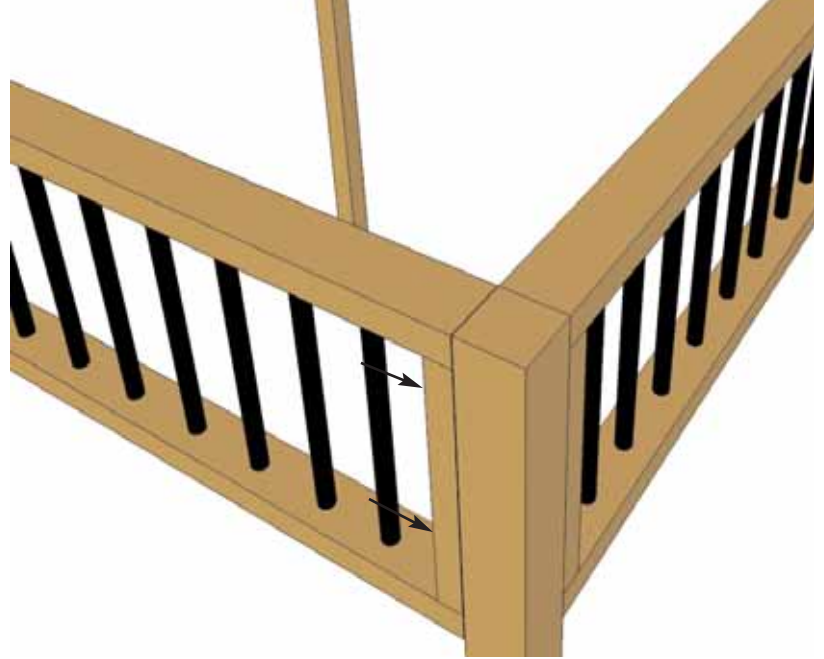

8. When positioned correctly, attach Upper Baluster Section to Post with 4 - 2 1/2" screws per side as described in **Step 3**. At this stage, the post/baluster assemblies should be able to support themselves.



9. Complete the final Upper Baluster Attachment.



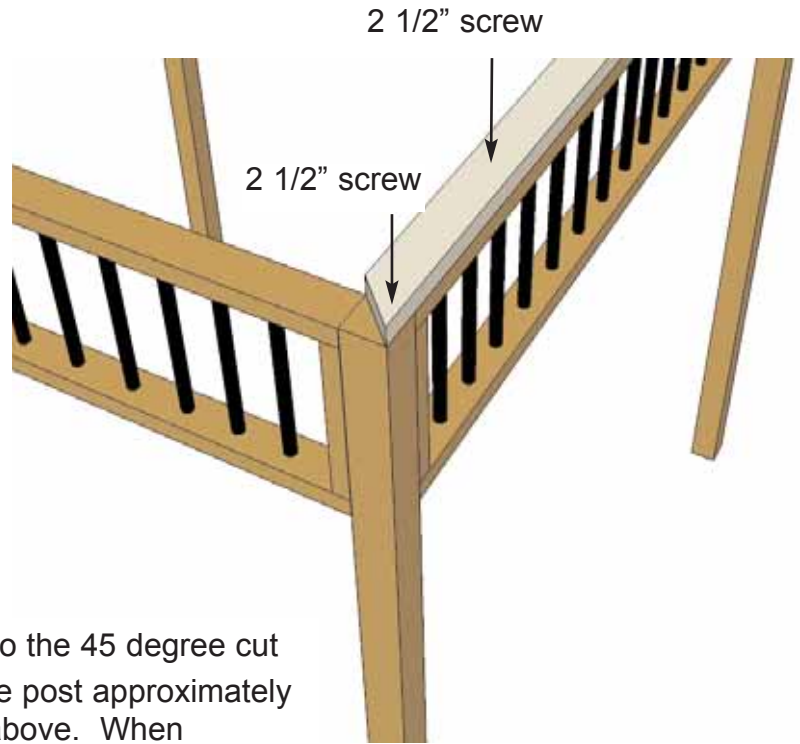

10. Next, attach **Top Plates**. The Top Plates will tie your post and balusters together. There are 2 Top Plates per side (left and right both with a 45 degree cut on the end. Locate and position on top of post/baluster assembly.

11. Place Top Plate so the 45 degree cut on the end sits over the post approximately halfway as illustrated above. When positioned correctly, attach to post/baluster assembly with 4 - 2 1/2" screws per piece. Make sure to place a screw from top plate into post. Drill pilot hole to prevent splitting.

Drill end screw into Post.

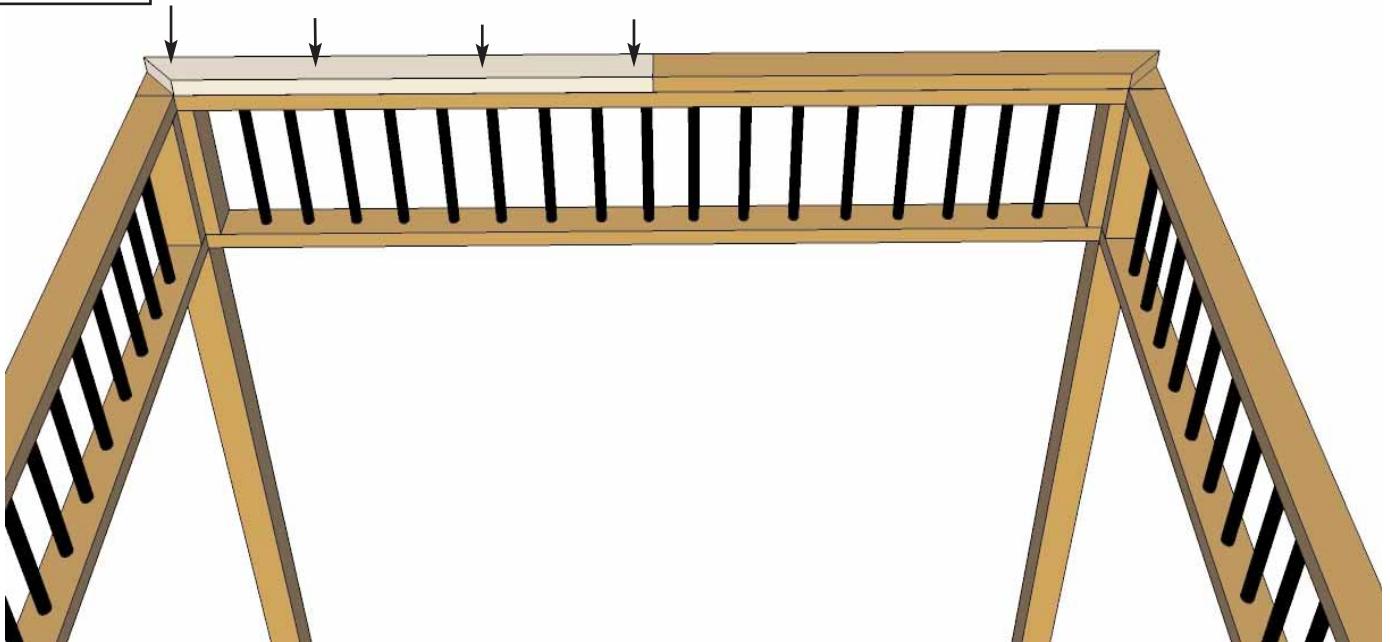

12. Position 2nd Top Plate on post/baluster assembly and fasten down as per **Step 11**.

Both Top Plates should be flush and sitting on the post equally.

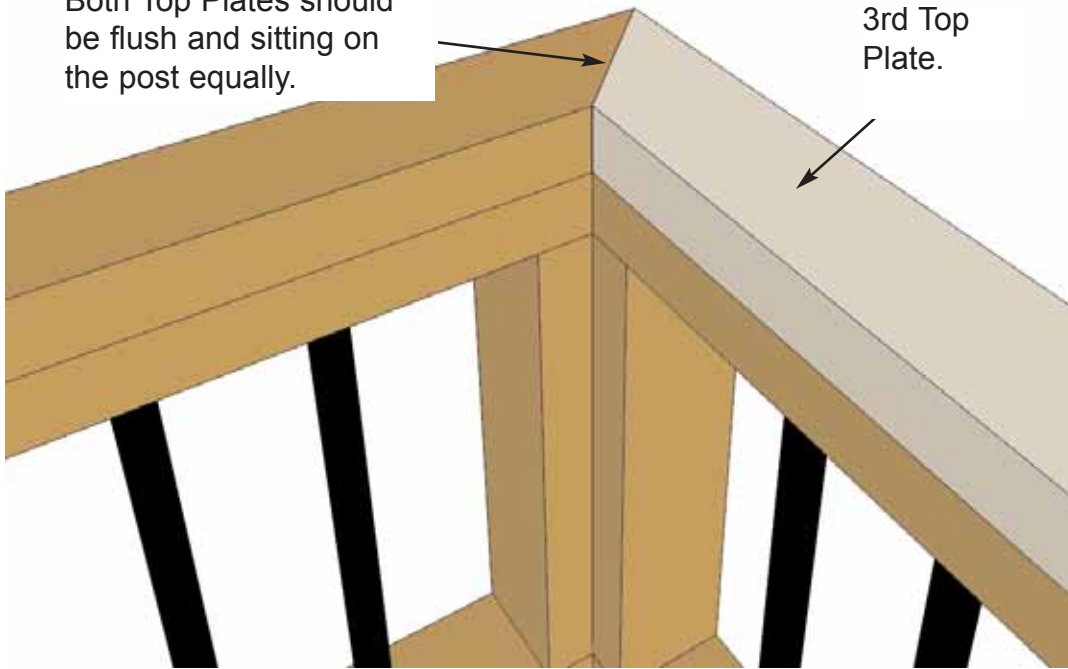

3rd Top Plate.

13. Position 3rd Top Plate down and attach to post/baluster assemblies as described earlier.

14. Complete remaining Top Plate attachments working in a clockwise direction.

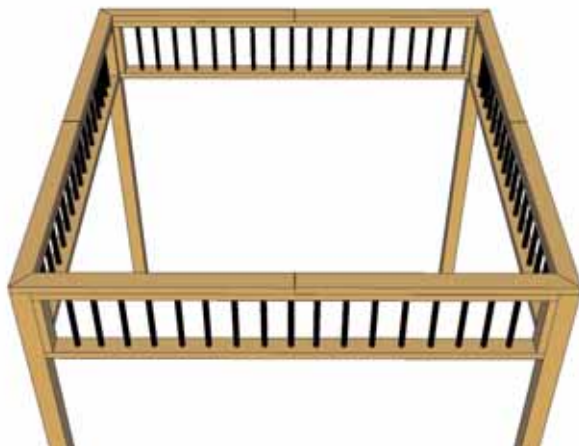

When completed, you are ready to start Corner Bracket Attachments.

centered on bottom
of baluster section

15. Locate all 8 Black Powder Coated Aluminum **Corner Brackets and Black 2" Screws.**

Position Corner Bracket on post and underside of baluster section centering in the middle of each.

Attach with Black screws into the Brackets pre-drilled holes.

Important- Do not over-tighten bracket screws. **Use screw driver to finish off.**

Note:

Prior to attaching Brackets, use a level to square up your posts.

centered on
post

16. Complete all remaining Corner Bracket attachments.

Even though Corner Brackets are engineered to be exactly 90 degrees, use a square or a level to align your post prior to attaching each bracket.

Time to Start the Roof!



17. Locate your **Skybox.** Dimension of **Skybox** is 5 1/2" high x 37" l x 37" l.

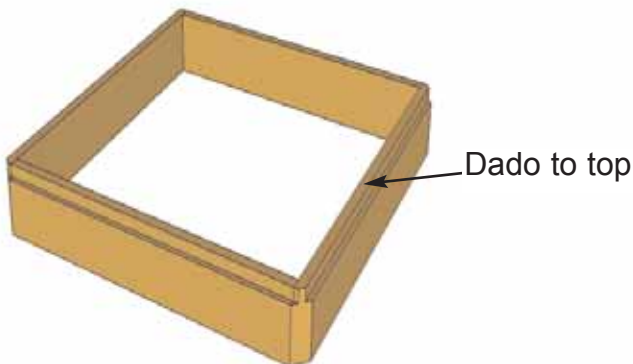

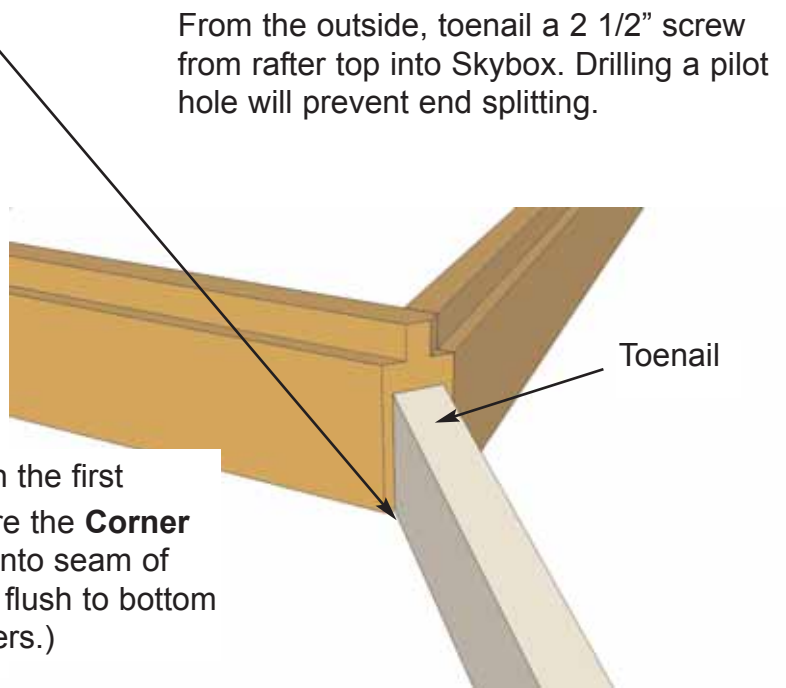
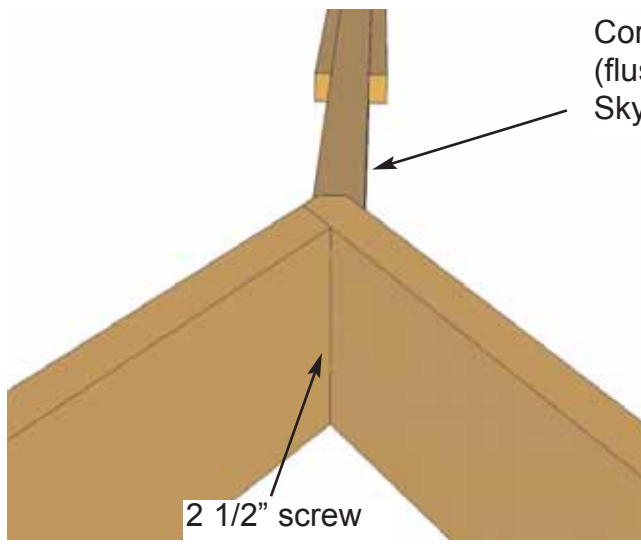

18. While your helper holds up the Skybox, attach the first Corner Rafter to the Skybox from the inside. Secure the **Corner Rafter** to the Skybox with 2 - 2 1/2" screw. Screw into seam of Skybox straight into the rafter. Make sure Rafter is flush to bottom of Skybox. (Corner Rafters will be your longest rafters.)



19. While still supporting your Skybox, complete all other Corner Rafters. When complete, your Skybox/Corner Rafter will support itself.

20. Before attaching the **Center Rafters** to Skybox, first attach **Simpson Strong Ties** (long side down) to bottom of rafter. Attach tie with 2 - 1 1/4" screws where rafter angle changes.

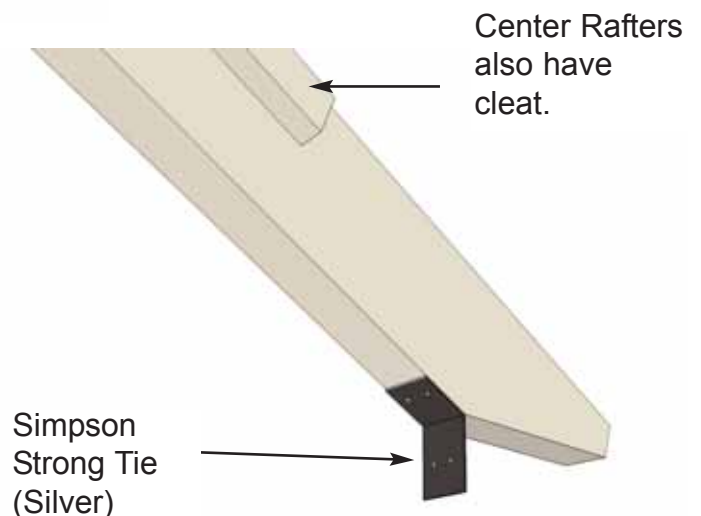

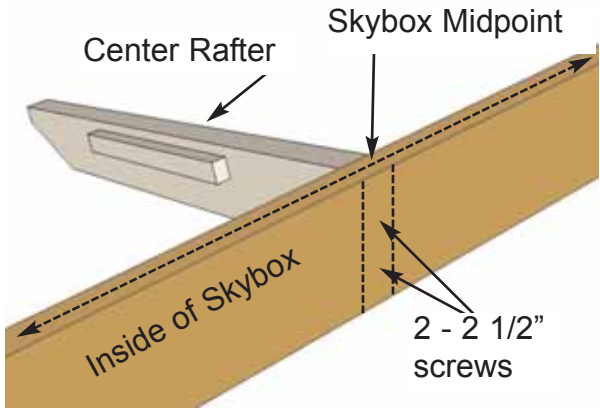

21. Prior to attaching Center Rafters, find the Skybox midpoint (18.5" on center). Secure rafter at midpoint with 2 - 2 1/2" screws from inside of Skybox into rafter.

MAKE SURE RAFTER IS FLUSH AT BOTTOM OF SKYBOX.

22. Toenail the Center Rafter to Skybox with a 2 1/2" screw. Rafter will be flush at the bottom. Complete all other Center Rafter/Skybox attachments.

Important- Be careful not to bend or scratch attached Simpson Strong Ties.

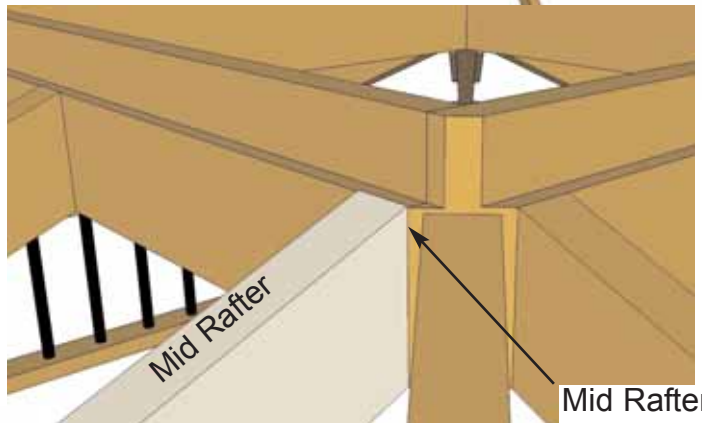
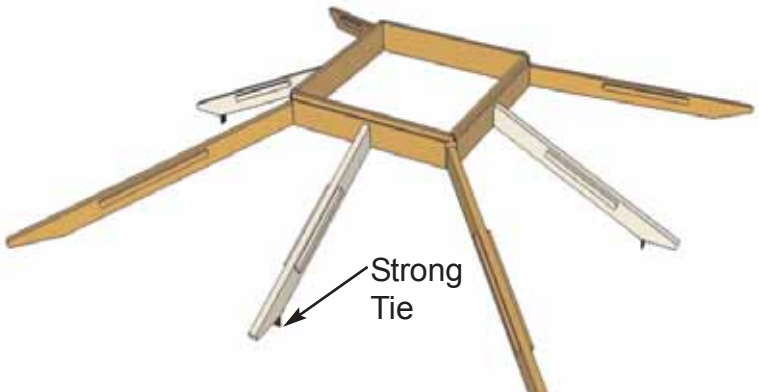
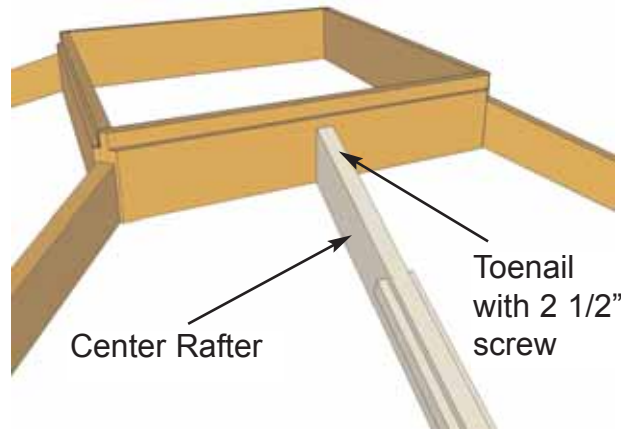

Mid Rafter is positioned on edge of Skybox



23. Finally, attach **Mid Rafters** to Skybox. There are 8 Mid Rafters and each is positioned on the edge of the Skybox. Attach as per other rafters.

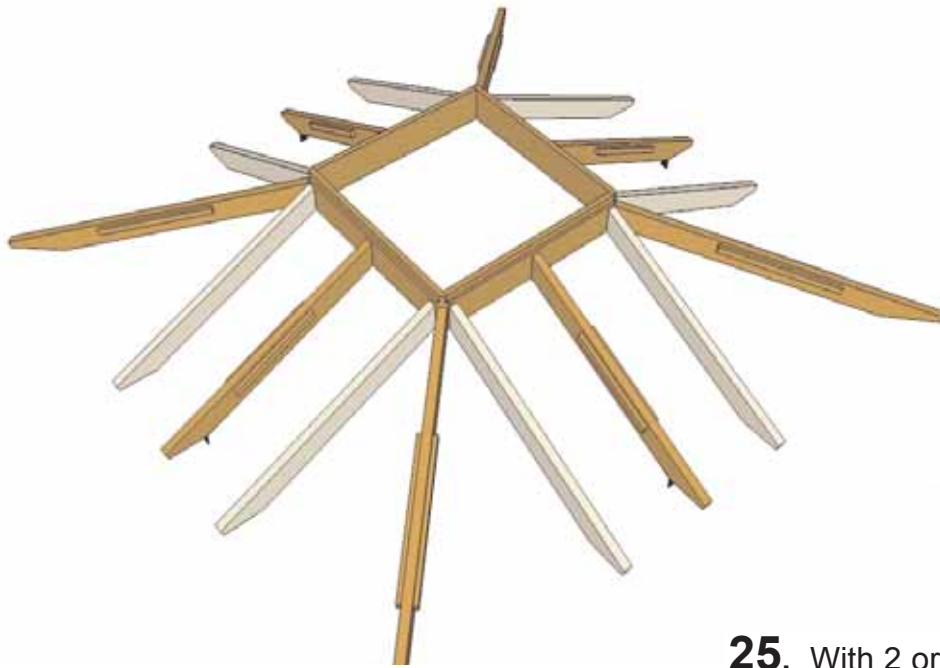

24. Picture illustrated to left shows all Mid, Center and Corner Rafter attachments.

Next Step...

Positioning the rafter sections on the post/baluster section.

25. With 2 or 3 helpers, carefully lift up your completed rafter section and place on top of your post/baluster section. Position Rafters in their approx. location.

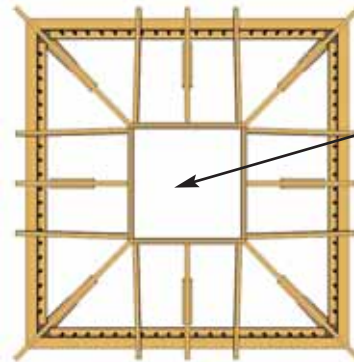

Bird's eye view of rafters sitting on top plates.

Center Rafter

Simpson Strong Tie

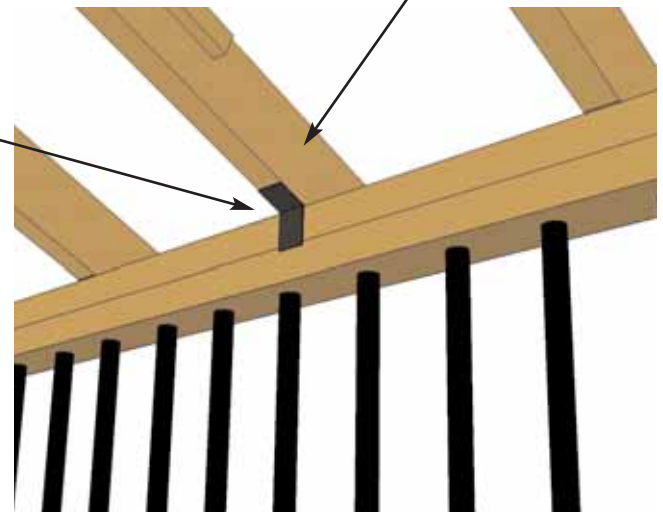

26. When inside the Naramata, the Center Rafter Simpson Strong Tie should sit flush against Top Plate and be centered between posts. Check all Center Rafter locations and when positioned correctly, screw the Strong Ties into Top Plate / Baluster with 2 - 1 1/4" screws per side.

Screw Corner Rafter down with 4" screw. Pilot hole first to make it easier to screw.

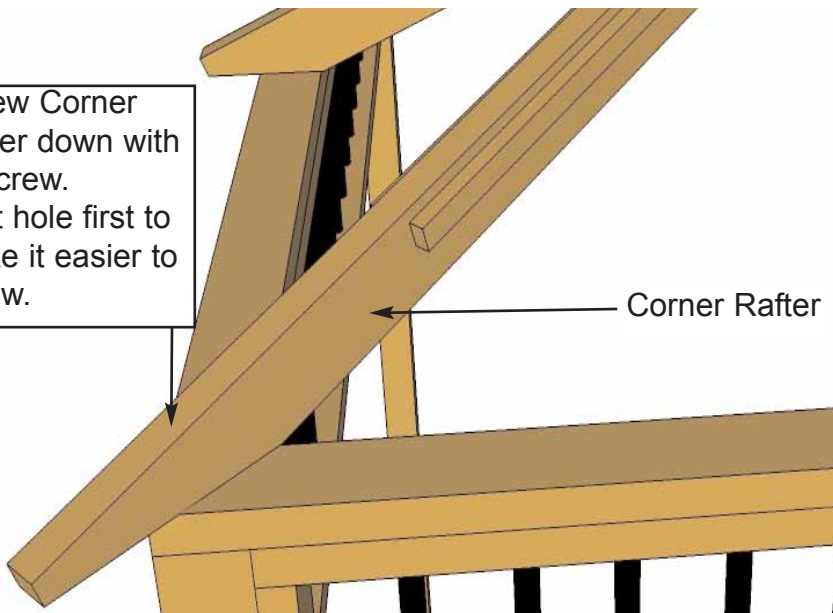

Corner Rafter

28. Screw Mid and Center Rafters down into Top Plates with a 4" screw per rafter similar to Step 27.

27. Position Corner Rafters so they sit equally on corners of Top Plates. Screw rafters down into plates with 1 - 4" screw.

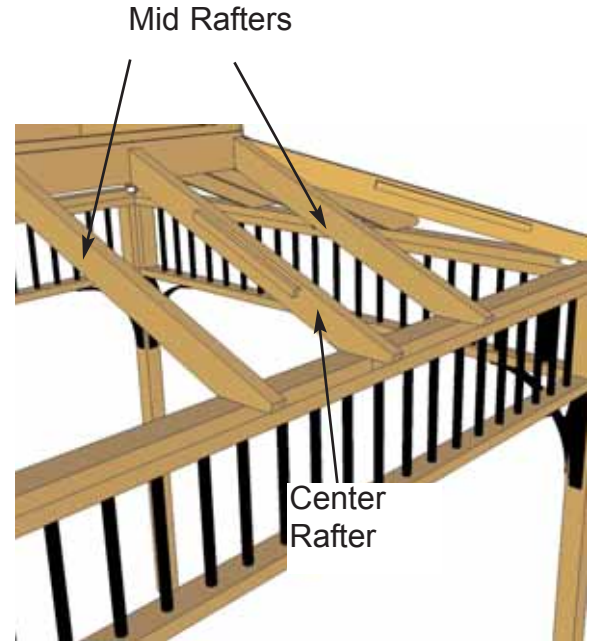

Mid Rafters

Center Rafter

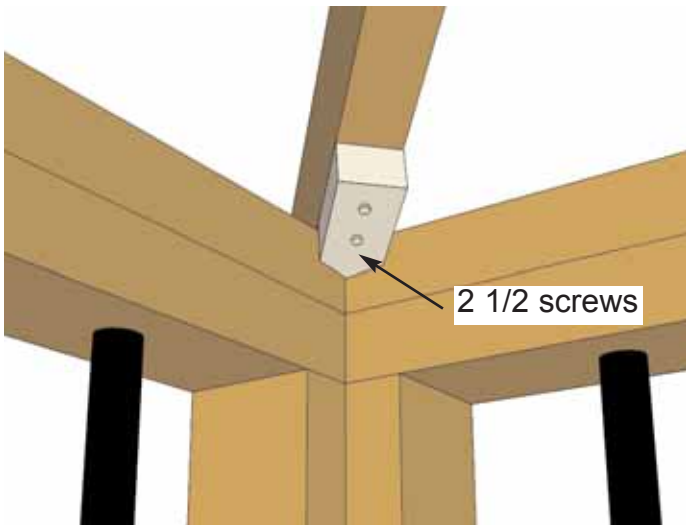

2 1/2 screws

29. Finally, to secure Corner Rafters, position **Locking Corner Lock Blocks** in bottom corner or Corner Rafter and secure with 2 - 2 1/2" screws. Complete all 4 corners.

30. From the outside, attach all 4 Black Aluminum **Corner Post/Top Plate Caps** to top of outer post in corners. Use 2- 2" black screws to secure. Caps should be flush with Top Plate and Corner Rafter.

Corner Post/Top Plate Caps not included in Getaway Model.

Time to Start the Roof!

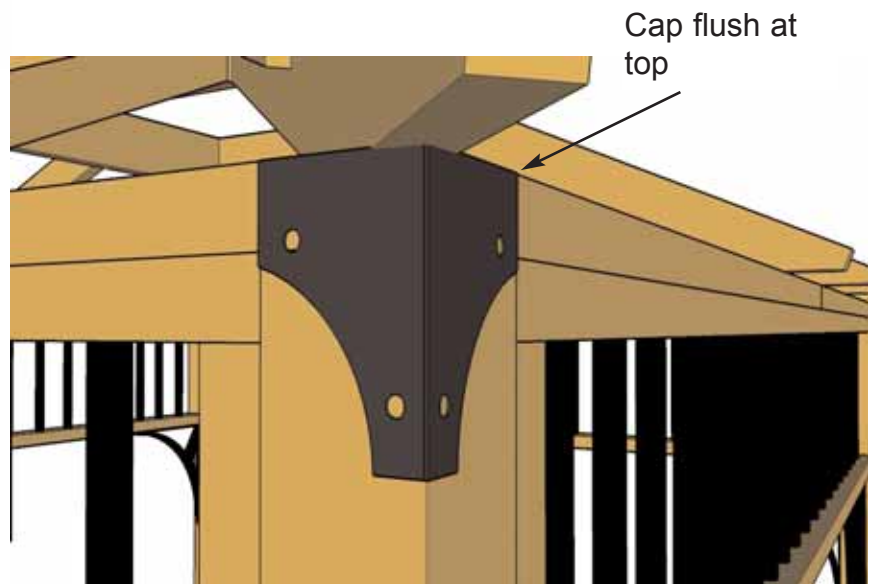

Cap flush at top



31. You will need a step ladder to complete the roof section. **Be Careful when working on the ladder!** Lift and position the first **Right Sided Roof Section** into place on the rafters. (There are 4 Right and Left Sided Roof Panels).

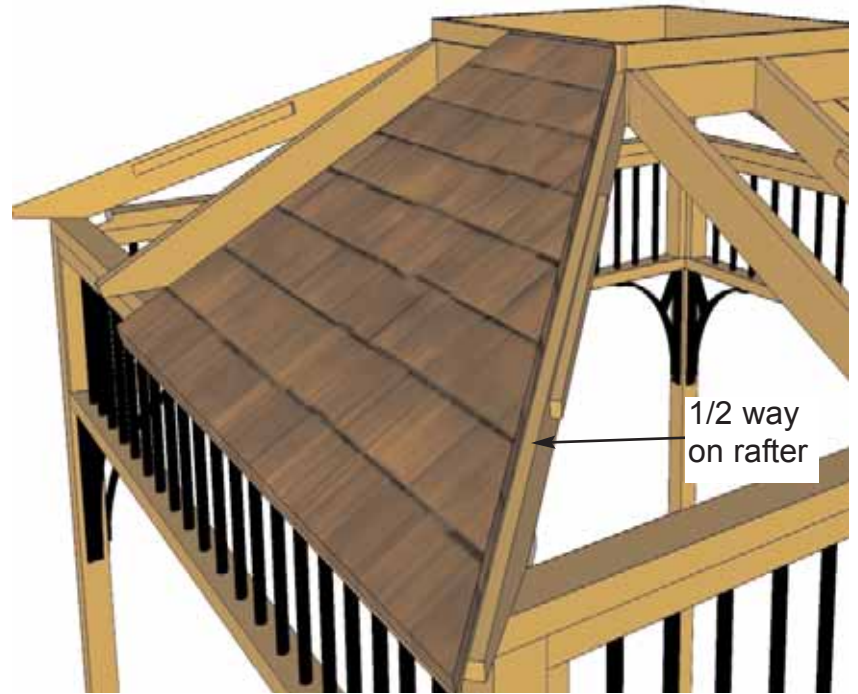

32. Place Right Sided Panel so it sits approximately 1/2 way on the Center Rafter

Roof is sitting in dado slot and sitting 1/2 on Center Rafter

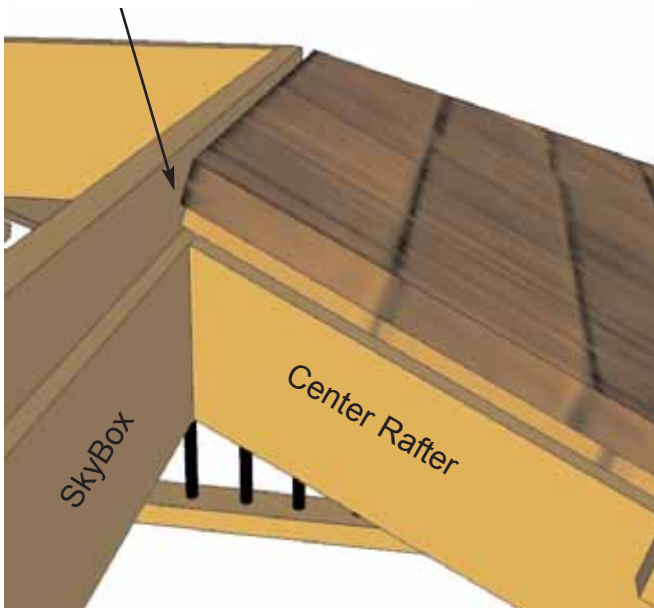

33. Position roof so panel sits flush in Dado Slot of Skybox and is centered approximately 1/2 way on Center Rafter.

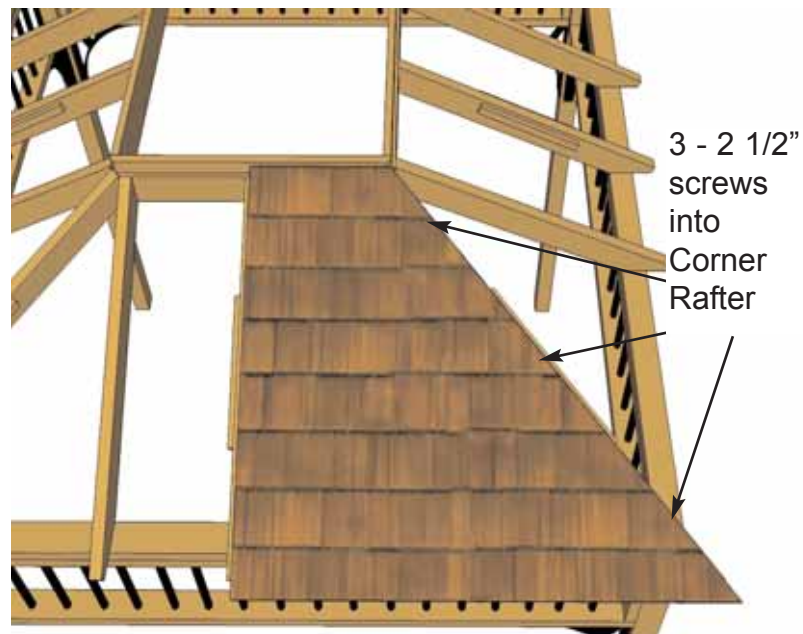

34. When Right Sided Roof Panel is positioned correctly, attach roof panel to Corner Rafter with 3 - 2 1/2" screws.

DO NOT SCREW ROOF PANEL DOWN TO CENTER RAFTER AT THIS POINT!

35. Lift and place the second roof panel into position. We show a **Left Sided Roof Section** being attached.



36. Position and attach as per **Steps 31-34.**

Important - There will be small gaps or seams where roof panels come together. We suggest that before completely attaching roof panels down that you tack panels down initially. You may want to reposition roofs slightly after all the panels are up to get the best fit for your Naramata.



37. Continue adding Roof Panels. Remember, there will be small seams between roof panels that will be covered later. It is more important to center the panels correctly on the rafters.



Birds eye of partially completed roof



38. The illustration to the right shows the Naramata with all the roof panels positioned correctly on the roof rafters. Once again, you may want to reposition some of roof panels to get the best fit. When completed, complete all Roof Panel/ Corner Rafter Attachments. Do not screw panels to Center Rafters at this point.



Screw first filler shingle down to rafters using 1 - 2 1/2" screw per panel (2 in total). Make sure to screw into both rafter.



39. Secure Roof Panels to Center Rafter using 2 - 2 1/2" screw. Make sure to screw into Center Rafter

40. Slide first 18" long **Filler Shingle** where roof panels meet until flush at bottom.

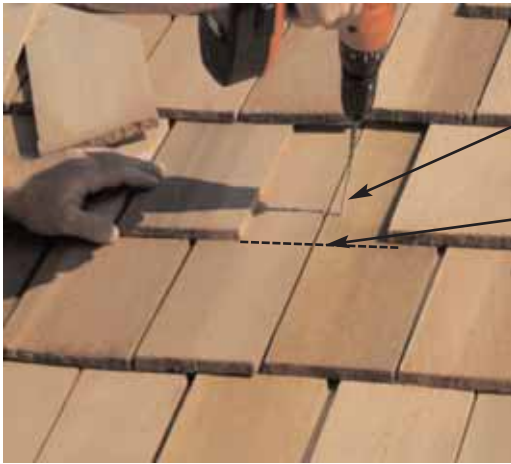

attach above the exposure line.
exposure line



41. Screw first Filler Shingle down to Center Rafters as per **Step 40**.

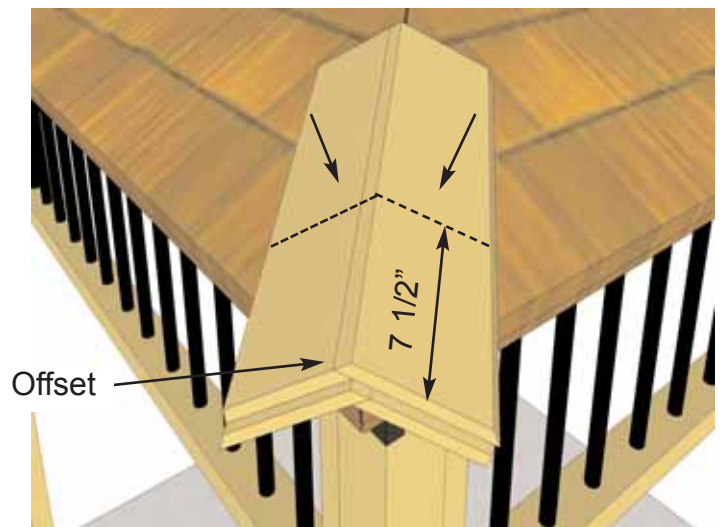

42. Locate all **Roof Ridge Caps**. Note, Ridge Caps are offset to one another. Place 1st Ridge Cap on roof seam slightly overhanging roof end and attach with 2 - 1 1/4" Shingle Nails. Position 2nd Ridge Cap offset to 1st. Align on top and nail down with 2 Shingle Nails approximately 9" from Ridge Cap butt.

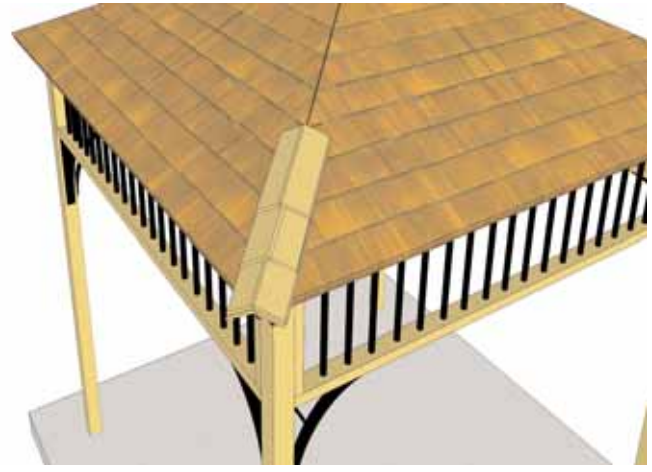
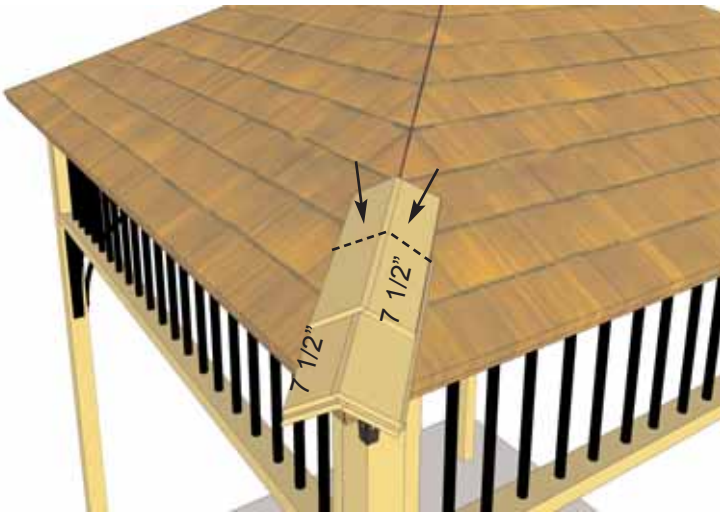

43. Place 3rd Ridge Cap 7 1/2" up from butt of 2nd Cap and nail with 2 Shingle Nails approximately 9" from the butt. Make sure to alternate Ridge Cap offsets as you complete each row. Position and attach 4th Ridge Caps as previously described.

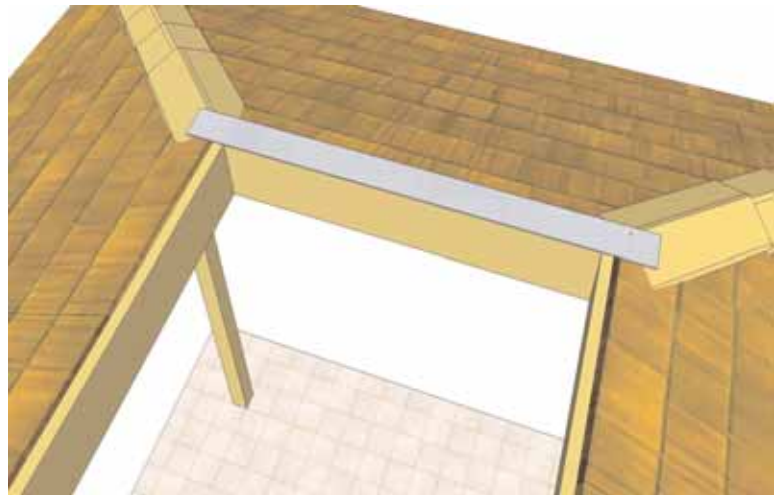

44. Complete remaining Long Ridge Caps. On top of the roof, carefully position Skylight/Roof Flashing on Skybox. Space evenly from side to side on Skybox making sure Flashing does not protrude past the Skybox on the inside. Staple down to Skybox when in correct position.

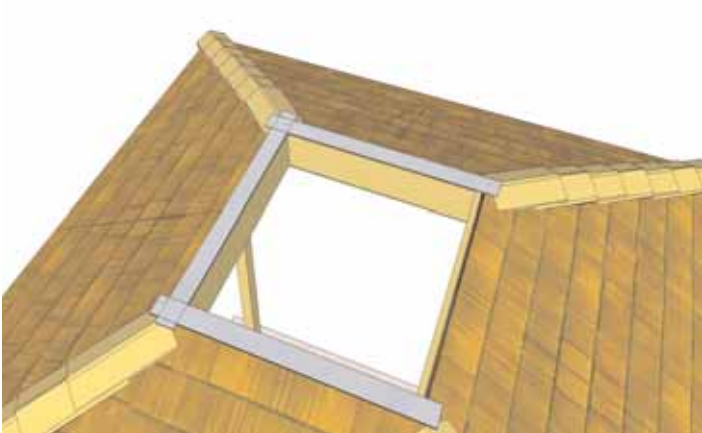

45. Complete alignment and attachment of remaining Flashing Strips as per **Step 44.**

Near end, Hand tighten Screws to prevent cracking.

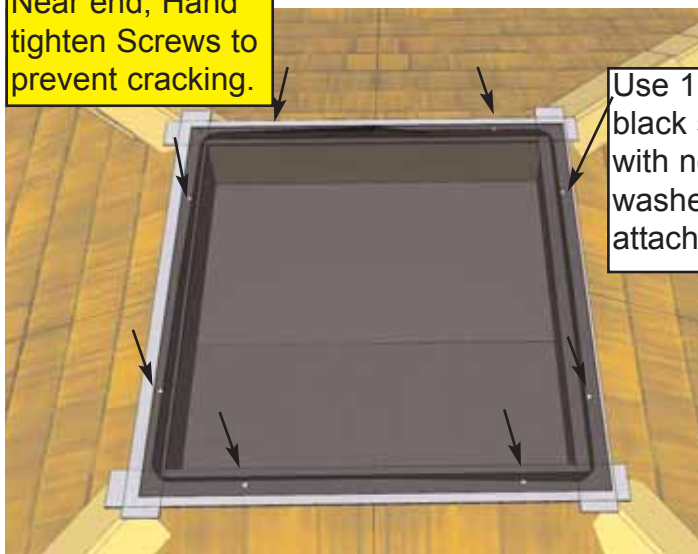

Use 1 1/2" black screws with neoprene washers attached



Drill 1/8" Pilot Hole in Skylight Trim prior to attaching.

46. Prior to lifting your **Skylight** into place, carefully remove the blue protective layer of plastic. Lift up and carefully place the skylight into position on the Skybox. The Skylight is pre-drilled for your convenience. Use 8 - 2" black screws with neoprene washers to attach. Screw down so Skylight is snug only. Do not overtighten or Skylight will crack. **Hand tighten only.**

47. Position Skylight Trim to cover Flashing. Drill 1/8" pilot holes near both ends and attach with 2 - 2 1/2" screws. Screw trims to rafters if possible.

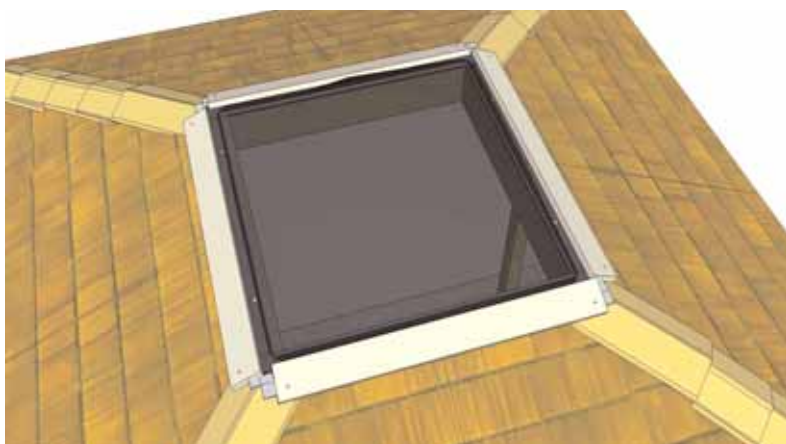

48. Complete alignment and attachments of remaining Skylight Trims as per **Step 47.**

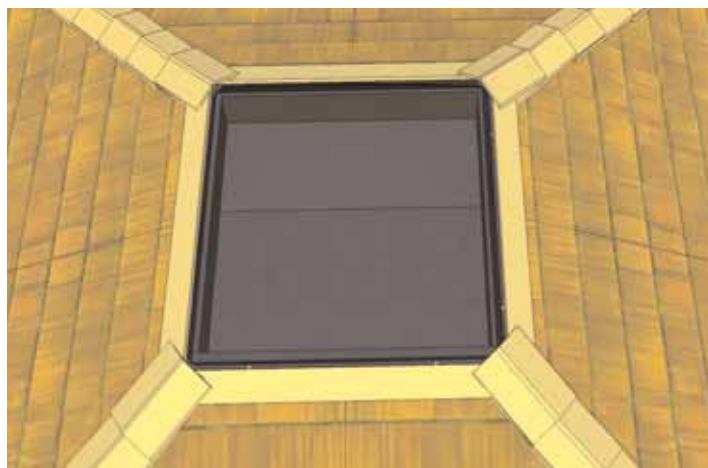
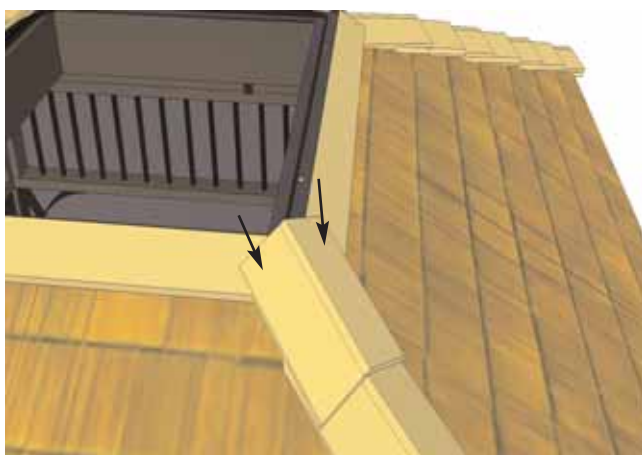

49. Place 10" long Roof Ridge Cap over Skylight Trim. Align and Drill 2- 1/8" pilot holes in each end of Cap. Carefully screw Ridge Cap down to Skylight Trim with 2 - 1 1/4" screws. Complete all corners.

Congratulations on building your 9x9 Naramata Spa Shelter!

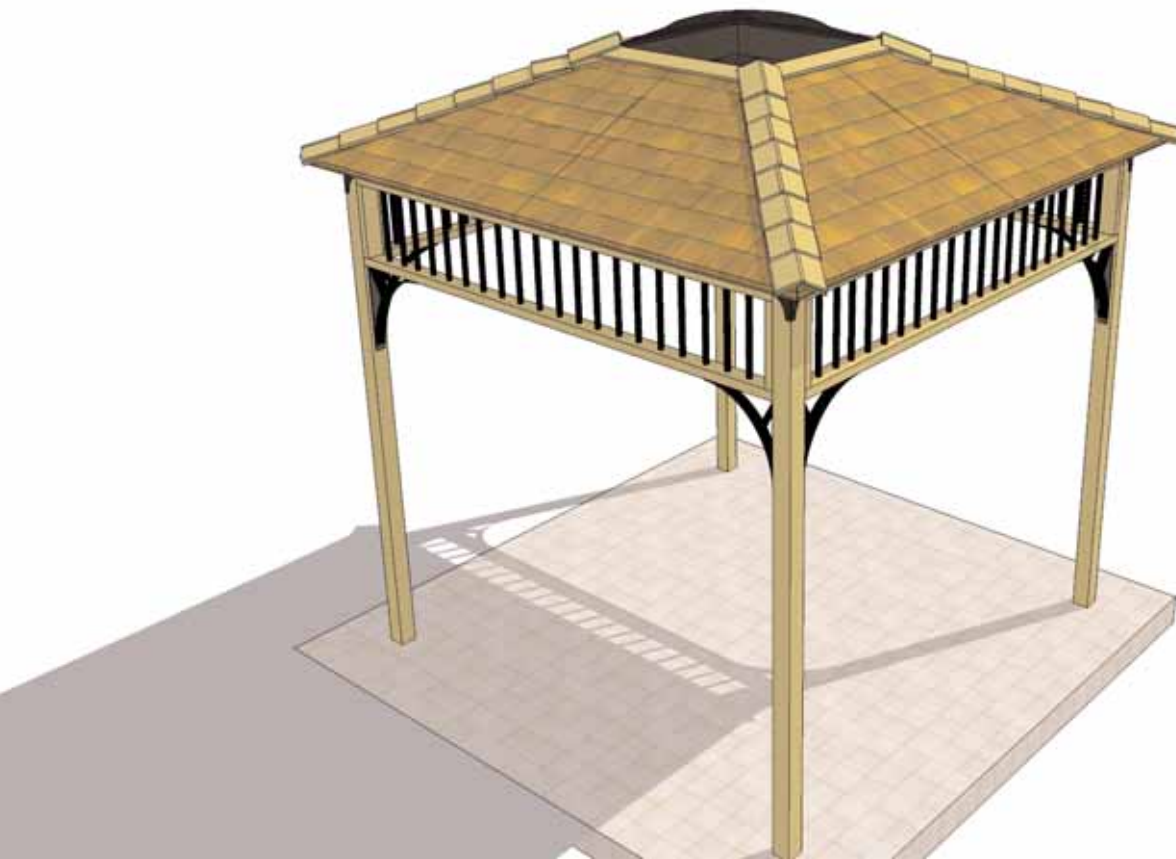

Note; Our Spa Shelters are shipped as an unfinished product. If exposed to the elements, the western red cedar lumber will weather to a silvery-gray color. If you prefer to keep the cedar lumber looking closer to the original color, we suggest that you treat the wood with a good oil base wood stain. You may also wish to paint your new shed rather than stain it. In both cases we recommend that you consult with a paint and stain dealer in your area for their recommendations.

We hope your experience assembling the Naramata Spa Shelter has been both positive and rewarding.

We value your feedback and would like to hear back from you on how well we are doing in the following areas:

- 1. Customer Service**
- 2. On Time Shipping**
- 3. Motor Freight Delivery**
- 4. Quality of Materials**
- 5. Assembly Manual**
- 6. Overall Satisfaction.**



The materials contained in this Assembly Manual may be downloaded or copied provided that ALL copies retain the copyright and any other proprietary notices contained on the materials. No material may be modified, edited or taken out of context such that its use creates a false or misleading statement or impression as to the positions, statements or actions.

Please call, write or email us at:

Outdoor Living Today

Canadian Address
9393 287th Street
Maple Ridge, British Columbia
Canada V2W 1L1

United States Address
P.O. Box 96
Sumas, Washington
USA 98295