

# 8x12 Cedar Greenhouse Assembly Manual

Revision #12.1  
August 31, 2022

Thank you for purchasing an 8x12 Cedar Greenhouse. Please take the time to identify all the parts prior to assembly.

#### Safety Points and Other Considerations

Our products are built for use based on proper installation and normal residential use, on level ground. Please follow the instruction manual when building your Greenhouse and retain the manual for future maintenance purposes.



Some of the safety and usage measures you may wish to consider include:

- snow load ratings vary by geographical location. If heavy or wet snowfall occurs, it is advisable to sweep the snow off the roof(s).
- if the product is elevated, any structural and building code requirements are solely the customer's responsibility, and should be abided by.
- in high or gusty wind conditions it is advisable to keep the structure securely grounded.
- have a regular maintenance plan to ensure screws, doors, windows and parts are tight.

Customer agrees to hold Outdoor Living Today Partnership and any Authorized Dealers free of any liability for improper installation, maintenance and repair.

**In the event of a missing or broken piece, simply call the Outdoor Living Today Customer Support Line @ 1-888-658-1658 within 30 days of the delivery of your purchase. It is our commitment to you to courier replacement parts, free of charge, within 10 business days of this notification. Replacement parts will not be provided free of charge after the 30 day grace period.**

**Thank you for purchasing our 8x12 Cedar Greenhouse.  
Please take the time to identify all the parts prior to assembly.**

V - Inside Vent Frame  
CC - Front Vertical Door Filler  
CCC- Front Hor. Door Filler  
PP - Vent Window Trims  
Not Shown.

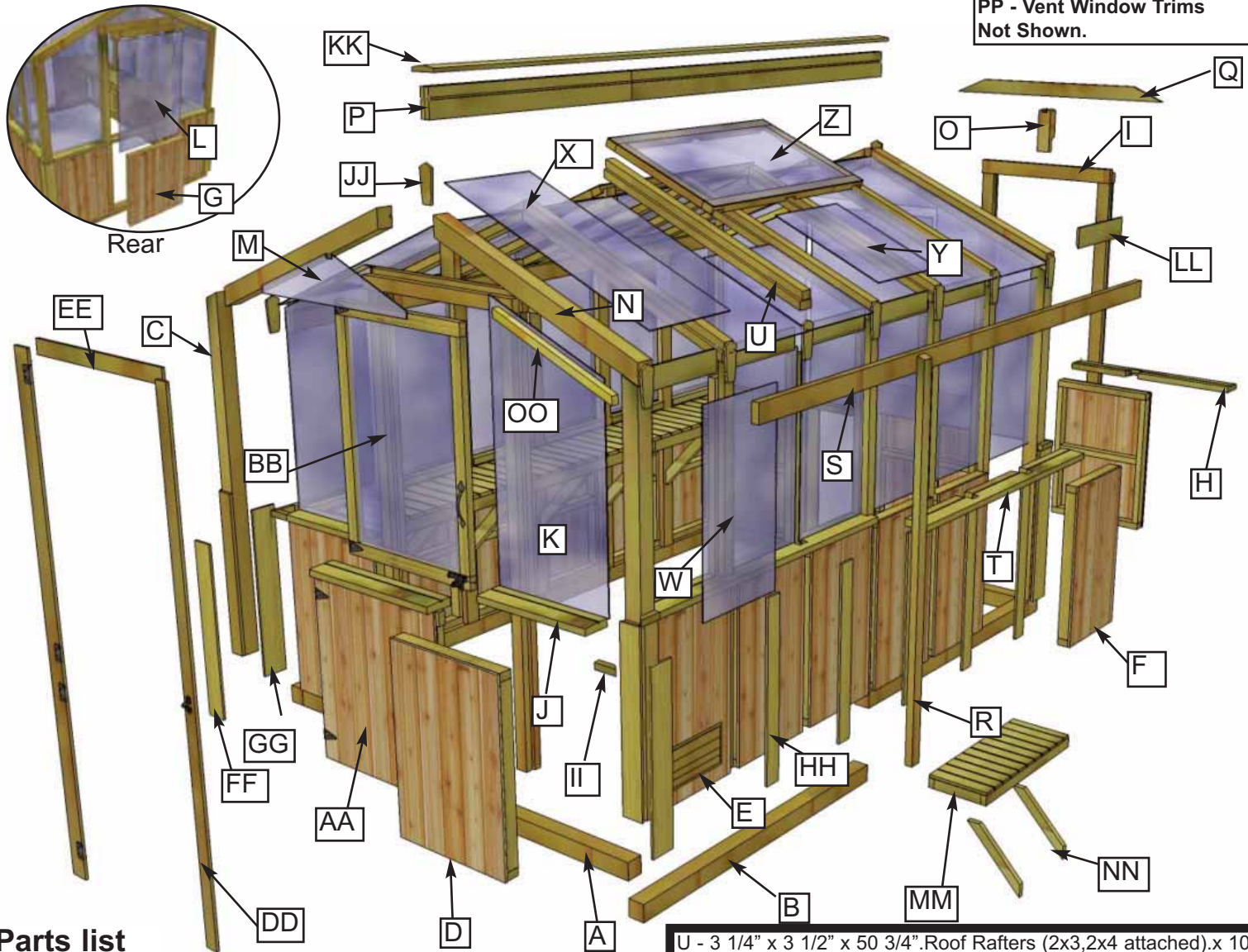

**Parts list**

- A - 3 1/2" x 3 1/2" x 44 1/4"...Foundation Posts - Front and Rear .x 4 pcs.
- B - 3 1/2" x 3 1/2" x 71"...Foundation Posts - Sides .....x 4 pcs.
- C - 3 1/2" x 3 1/2" x 76"..Vertical Corner Posts .....x 4 pcs.
- D - 25 1/2"w x 35"h..Front/Rear Walls .....x 4 pcs.
- E - 20 1/4"w x 35"h..Wide Side Wall with Vent .....x 4 pcs.
- F - 20 1/4"w x 35"h..Wide Side Wall .....x 8 pcs.
- G - 32 7/8"w x 35"h..Wide Rear Center Wall.....x 1 pc.
- H - 1 1/2" x 5 1/2" x 44 1/2" Rear Wall Top Cap - Notched.....x 2 pcs.
- I - 3 1/4" x 3 1/2" F/R Doorway/Wall Frame (Vertical/Hor.) .....x 2 sets.  
(2 Vertical Posts - 87 1/4" / 1 Horizontal Top Cap - 38" long)
- J - 1 1/2" x 5 1/2" x 25 3/8"...Front Wall Top Cap (L&R).....x 2 pcs.
- K - F/R Outside Angle Cut Polygal Windows.....x 4 pcs.
- L - Rear Center Polygal Window.....x 1 pc.
- M - F/R Top Triangular Polygal Windows.....x 2 pcs.
- N - 3 1/2" x 3 1/2" x 51"..Outside Roof Rafters (dado/drilled).....x 4 pcs.
- O - F/R King Stud.....x 2 pcs.
- OO - 1 1/2" x 1 1/2" x 27 1/2" Exterior Rafter/ Doorway Supports.x 4 pcs
- P - 2" x 5.5" x 83"...Roof Ridge Boards.....x 2 pcs.
- Q - 3/4" x 3 1/2" x 58 1/2".Gable Support Frame-angle cut ends..x 2 pcs.
- R-3 1/4" x 3 1/2" x 75 1/4"Side Vertical Posts(2x3/2x4 attached)x10 pcs.
- S - 1 1/2" x 3 1/2" x 66 3/4" ..Side Top Supports(Bevel Edge).....x 4 pcs.
- T - 1 1/2" x 5 1/2" x 66 3/4" ..Side Wall Top Cap - Notched .....x 4 pcs.

- U - 3 1/4" x 3 1/2" x 50 3/4".Roof Rafters (2x3,2x4 attached).x 10 pcs.
- V - 3/4" x 2 1/2" x 49" Inside Vent Framing Support .....x 2 pcs.
- W - Side Polygal Window.....x 12 pcs.
- X - Roof Polygal Windows.....x 8 pcs.
- Y - Small Roof Polygal Window .....x 4 pcs.
- Z - Vent Hinged Polygal Window.....x 2 pcs.
- AA - 32 1/2" x 35 1/2" Bottom Dutch Door .....x 1 pc.
- BB - 32 1/2" x 47" Top Dutch Door .....x 1 pc.
- CC - 3/4" x 2 1/2" x 87 1/4" Front Vertical Door Frame Filler ...x 2 pcs.
- CCC - 3/4" x 2 1/2" x 33"..Front Hor.Door Frame Filler .....x 1 pc.
- DD - 1/2" x 2 1/2" x 84 1/4".....Vertical Door Trim.....x 2 pcs.
- EE - 1/2" x 2 1/2" x 38".....Horizontal Door Trim.....x 1 pc.
- FF - 1/2" x 4 1/2" x 34 7/8".Outside Post Trim- Narrow.....x 4 pc.
- GG - 1/2" x 5 1/2" x 34 7/8".....Outside Post Trim- Wide.....x 4 pc.
- HH - 1/2" x 3 1/2" x 34 7/8".....Vertical Wall Trim.....x 12 pc.
- II - 1 3/8" x 1 1/2" x 4 7/8".....Corner Post Trim.....x 8 pcs.
- JJ - 1/2" x 3 1/2" x 10".....Detail Caps.....x 16 pcs.
- KK - 1" x 5 1/2" x 70 1/2".....Top Ridge Cap.....x 2 pcs.
- LL - 1/2" x 4" (8@ 19 1/8" & 4@ 19 1/2").Side Soffits .....x 12 pcs.
- MM - 16" x 45 3/8".....Potting Shelves.....x 6 pcs.
- NN - 1 1/2" x 2 1/2" x 20 1/2".....Potting Shelf Supports.....x 10 pcs.
- PP - 1/2" x 2 1/4" x 19 1/2".....Vent Window Trims.....x 4 pcs
- \*\* Temporary Post/ Wall Supports (3" high x 2 1/2" wide) .....x 2 pcs.
- \*\* Rafter Template Spacer 1 1/2" x 3 1/2" x 20 3/16" long.....x 1 pc.

**Note: All Trim Pieces will be positioned rough face out when installed.**

# 8x12 GREENHOUSE HARDWARE SHEET

## Hardware Kit (Provided)

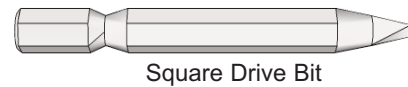
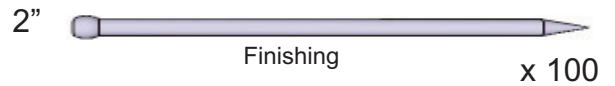

## Tools Required (Not Provided)



## Safety Equipment Required (Not Provided)



Recommended - Not Provided in Kit  
Landscape Cloth for an 8'x12' Footprint

## Selecting a Location for Your Greenhouse

Walk around your property and make notes of the following:

- sunny spots
- slope of the land
- light blocking trees and high buildings.

Don't hide your greenhouse away in a dark corner of the garden. Make it an attractive feature.

Ensure it has easy access to it and around it, to enable essential glass cleaning and general maintenance.

Place the Greenhouse on a level piece of land with good drainage. Take into account existing paths and utilities such as electricity and water.

Having a water supply at hand avoids carrying heavy watering cans from the tap to the plant.

## Choosing a Foundation & Flooring Material

**Dirt** - A dirt floor is the most inexpensive flooring option but it will be messy! Water will be absorbed easily and you can benefit from the natural heat.

**Sand & Gravel** - A sand and small gravel floor is also an inexpensive foundation option. Provides excellent drainage and easy to keep clean.

**Concrete** - When considering using a concrete floor, seek out a professional to pour the concrete and be sure to add water drains. Concrete floors also are great for holding heat and easy to clean and maintain. The downside of having a concrete foundation is that it is permanent and more costly.

**Brick/Stone** - Brick or stone floors are also a good option providing you leave adequate spacing between the bricks/stones to will allow water to drain and absorb into the ground. Bricks and stones also hold heat and are a good choice if cold weather is going to be an issue for your greenhouse.

After you have decided on the proper greenhouse foundation/flooring, it's important to take your time and install it properly. Be sure to remove any sod, grass, weeds, etc.. Always start with a packed and leveled dirt floor. By building your foundation as square and solid as possible, your greenhouse should bring years of enjoyment to you.

## Cleaning and Maintenance an Outdoor Living Today Greenhouse

**Polygal** - polycarbonate sheets– Simple cleaning will give longer and better service life. Rinse sheet with water. Use warm soapy (mild liquid dish soap) water to clean sheets. If any dirt remains, gently wipe off with a soft cloth. Apply final rinse and dry with soft cloth to prevent water spotting.

DO NOT use sponges, squeegees, brushes or sharp instruments as they may damage the UV protective coating.

**Western Red Cedar Wood**- Can be left to naturally weather to a silvery grey color or you can apply an exterior wood finish to keep the look of the original wood color. If choosing a finish, let the wood acclimatize under cover for two weeks and seal according to the paint manufacturer's specifications.

Types of Finishes:

Opaque Coatings & Semi-Transparent Stains. Opaque Coatings provide the most surface protection against weathering but will conceal the wood's natural characteristics. Semi-Transparent Stains may be latex or oil-based and will show the woods natural characteristics better. Semi's generally have a shorter service life of between 2-4 years.

**We recommend applying any sealants to individual pieces first before assembly and letting them dry to the paint manufacturer's directions.**

Dirt is the most benign cause of discoloration and not usually a problem. A periodic cleaning with a mild detergent solution will usually restore the surface finish. Mildew is a common cause of discoloration of paint, solid-colour stains and natural finishes. Restaining does not solve a mildew problem. When it is time to refinish, clean off the mildew with a commercial mildew-remover then refinish with a coating that contains an effective mildewcide.

We recommend using a Sand & Gravel Foundation and Floor System because it is simple and cost effective to complete. Basic instructions are highlighted below.

# A. Foundation

## Material List:

- One Cubic Yard of Sand- to cover 9'x13' - 2" deep.
- Landscape Cloth - to cover 8'x12' footprint.
- 4x4 Cedar Foundation Framing - Included in Kit (Parts A & B).
- Two Cubic Yards of Gravel (small) - to cover 8'x12' - 4" deep.
- 4 Tie Down Kits or 16 pcs -12" long Rebar - Optional.

## Instructions:

The first step to building a greenhouse is constructing a foundation, but before you begin you should have a level site prepared.

- Choose appropriate site.
- Excavate 9'x13' area to a depth of 2-3" and level dirt base.
- Lay Sand approximately 2" deep on base. Pack and level.
- Position 4x4 Cedar Foundation Framing on level sand base. Angle screw 4x4's together with 3" long screws (included). Make sure your 4x4 footprint is square. To do this, use your tape measure, and take two diagonal measurements of the base (One from the front left corner to the back right corner and the other from the front right corner to the back left corner). The base needs to be adjusted until the two measurements are the same. Optional- Secure 4x4's to the ground with Tie Down Kit or drill and hammer 16 -12" long Rebar pieces through 4x4's into the ground..
- Lay Landscape Cloth and cut excess fabric around the edges. Make sure you use a ground cover (also called weed barrier) that is made for landscaping and not black plastic or a tarp. Ground cover will allow water to drain through the fabric while keeping weeds from growing in your greenhouse.
- Pack approximately 4" deep of small Gravel to complete foundation and floor.

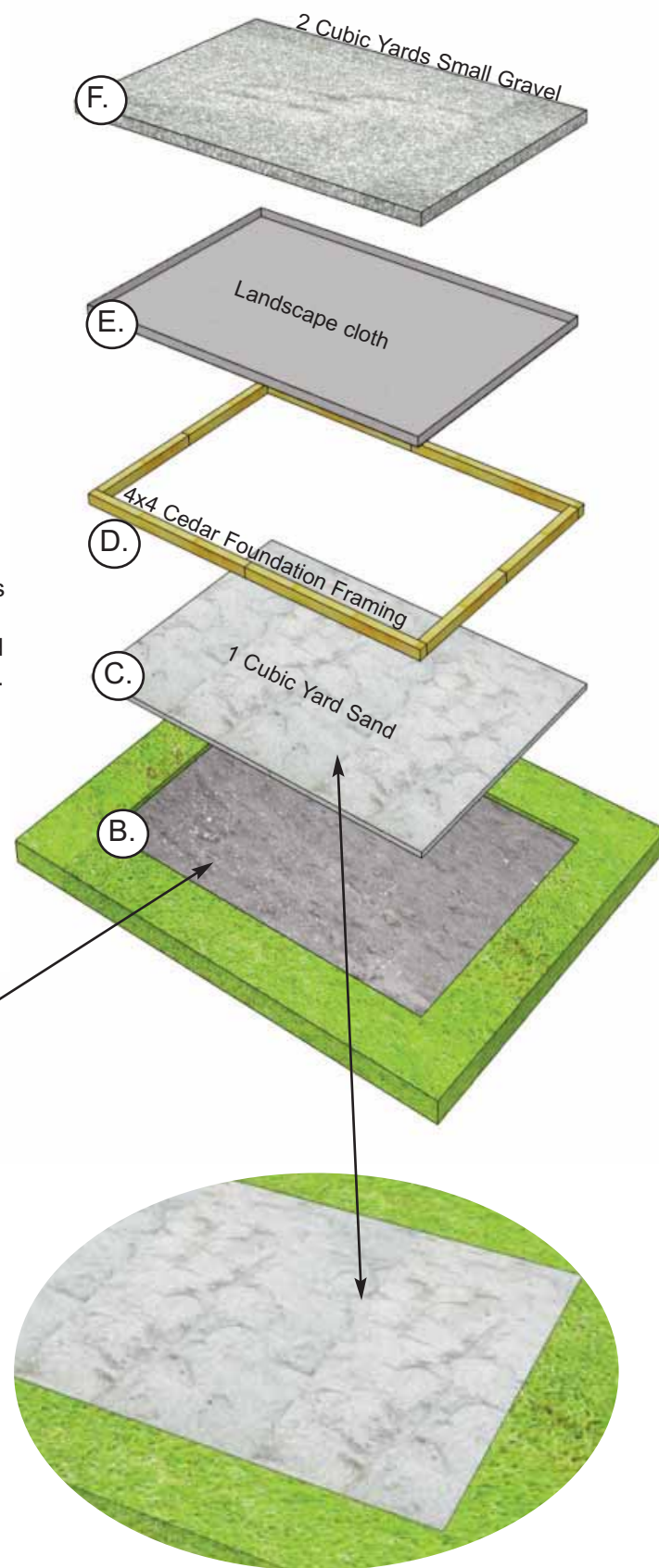

1. Excavate a site that is approximately 9'x13' - 2" deep. Level dirt base using a straight 2x4 piece of lumber and level. Make sure to leave enough space to allow for easy access around the Greenhouse once the unit is assembled. Lay approximately 2" of sand in base, pack and level.

**2.** Locate 4x4 Foundation Framings. 2 front / 2 rear - 44 1/4" long & 4 sides - 71" long. Lay on sand base. Position and level using straight 2x4 and level. Make a footprint so outside dimensions are approximately 96" wide x 142" long. Screw ends of 4x4 together with 2- 3" screws per end. Optional- Secure 4x4's to ground with Tie Down Kit or Rebar. See D. on Foundation Page.

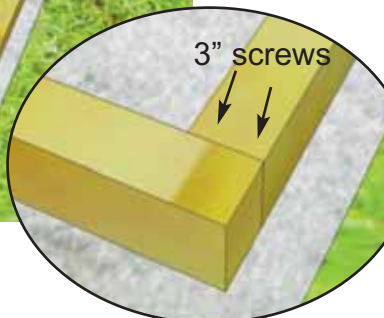
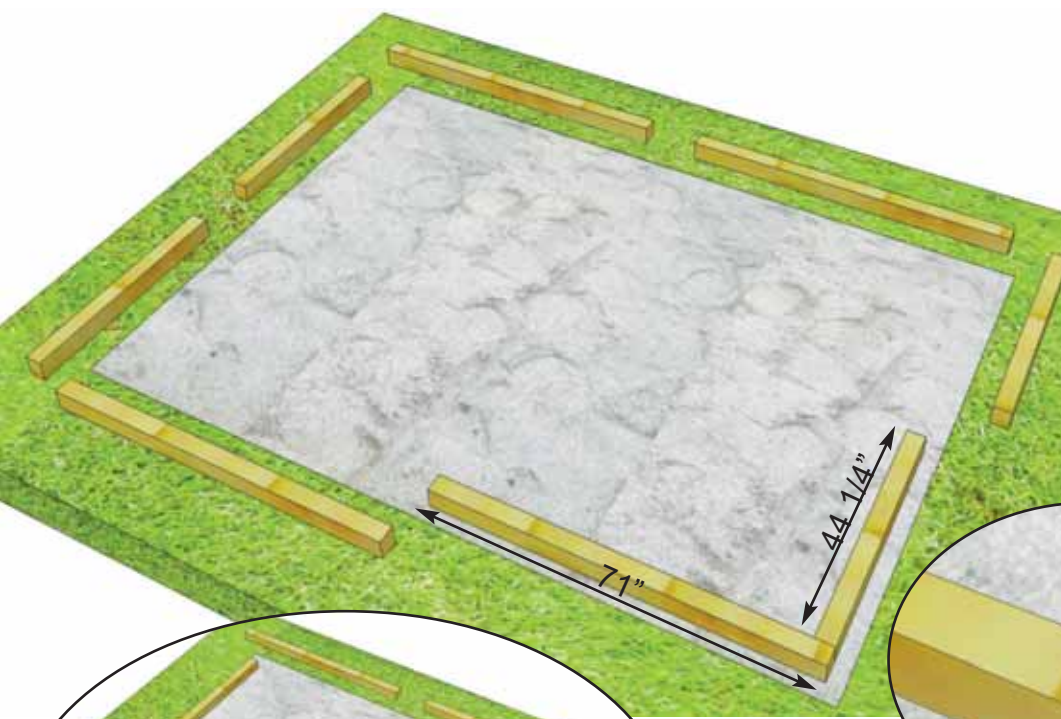

**You can find the Square Drive Bit for the screws in with the Hardware Kit Bag.**

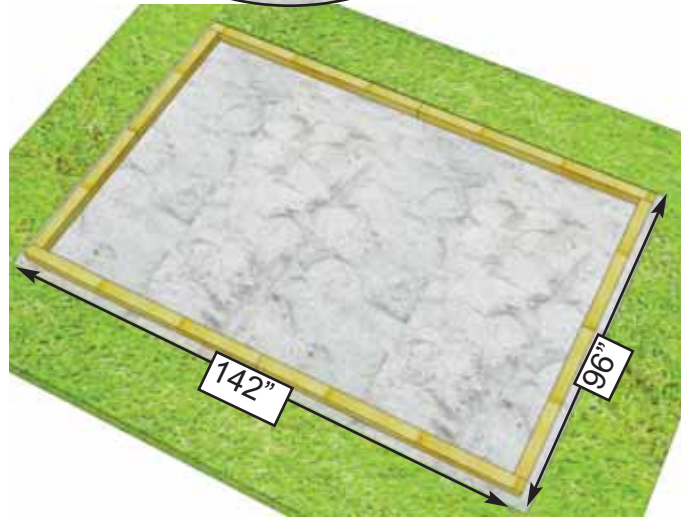
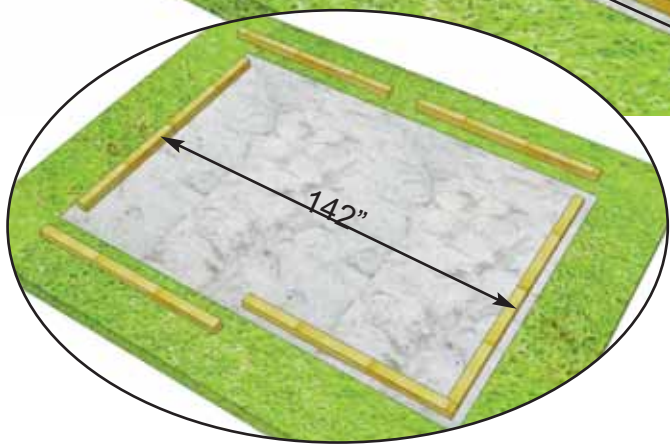

**3.** Position and cut Landscape Cloth to fit inside 4x4 Foundation Framing. Lay approximately 3-4" of Small Gravel and pack down.

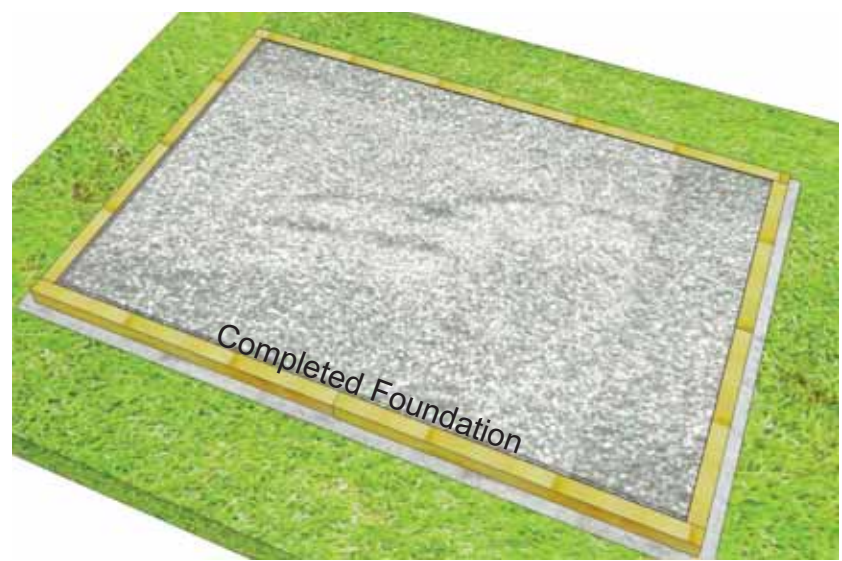
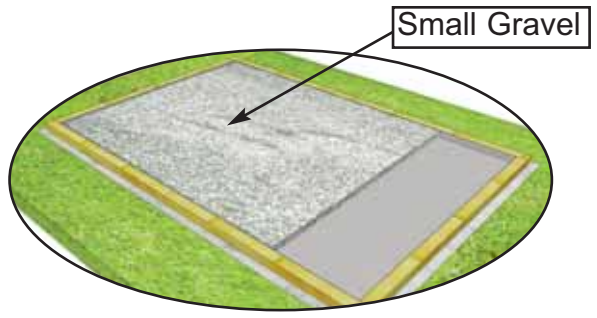
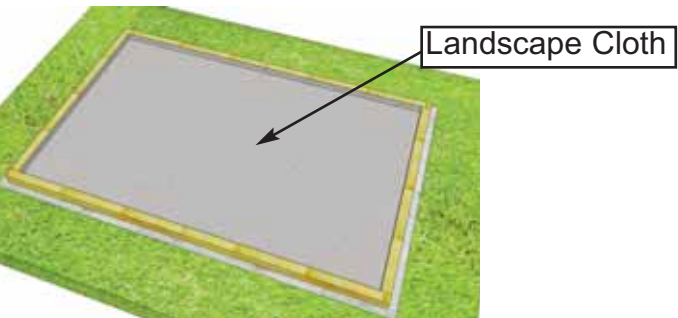

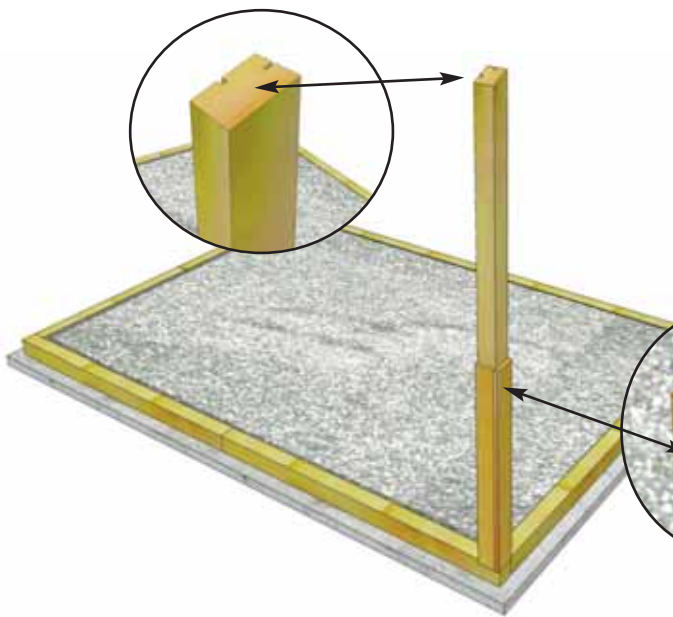

**4.** Locate 4 pieces - **Part C** (3 1/2" x 3 1/2"x 76" ). Starting with front left corner, choose and orientate Post as shown to the left with short angle cut top to the outside and dado cuts running top to bottom to the inside.

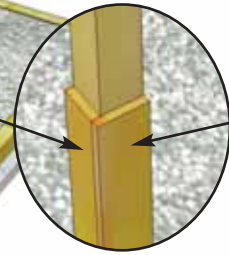

Posts attached filler trim will be orientated to the outside.

**Important:**  
Do not attach Walls to Foundation Framing until **Step 19.**

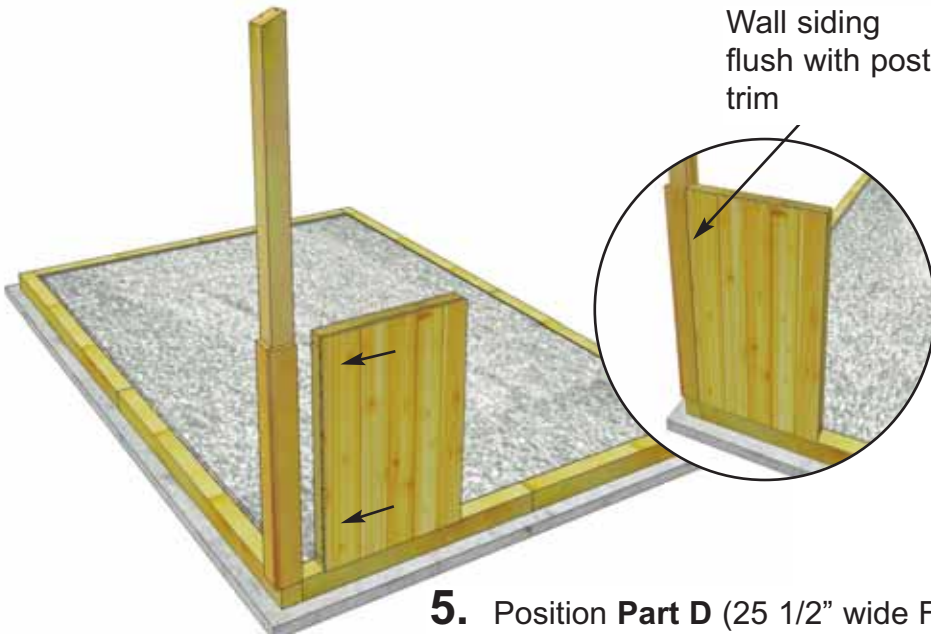

Wall siding flush with post trim



**5.** Position **Part D** (25 1/2" wide Front Solid Wall) even with bottom of Post and with Wall Siding flush with outside of Filler Trim of Post on the outside. Attach with 3 - 3" screws as shown above.

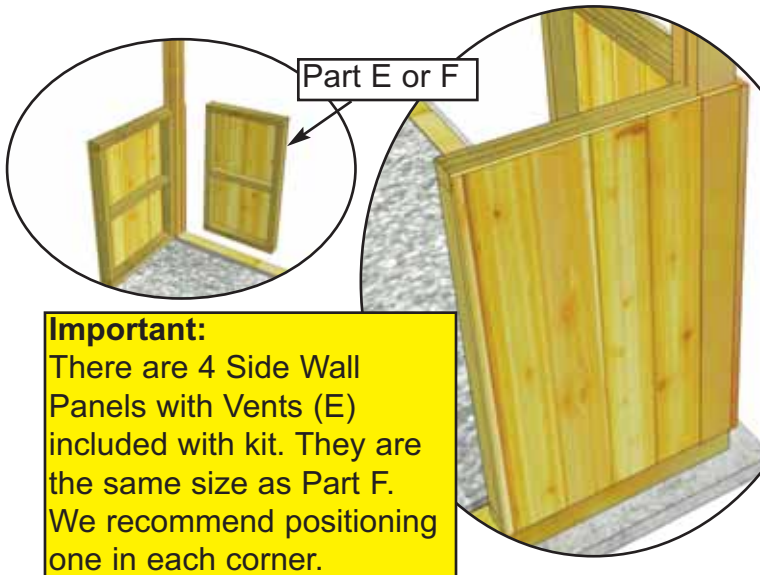

**Important:**  
There are 4 Side Wall Panels with Vents (E) included with kit. They are the same size as Part F. We recommend positioning one in each corner.

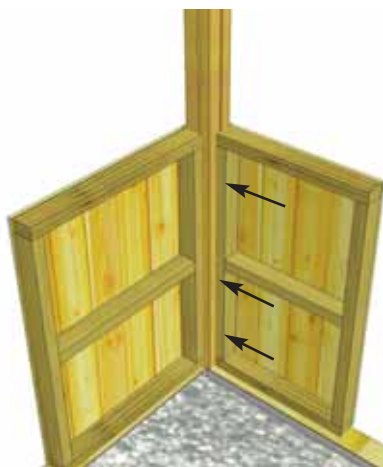

**6.** Position **Parts E or F** (20 1/4" wide Front Solid Wall) even with bottom of Post and with Wall Siding flush with outside of Filler Trim of Post on the outside. Attach with 3 - 3" screws.

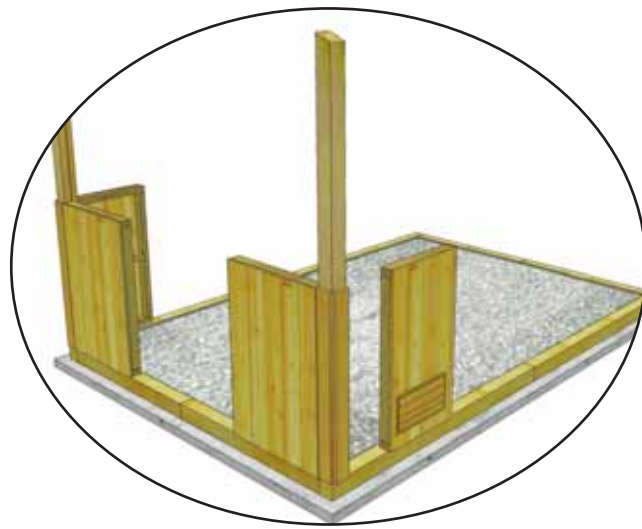
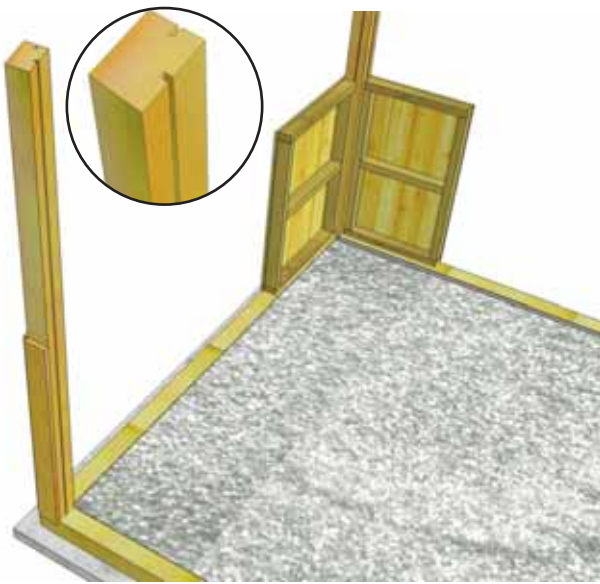

**7.** Complete remaining Corner Post/Wall attachments following Steps 4-6.

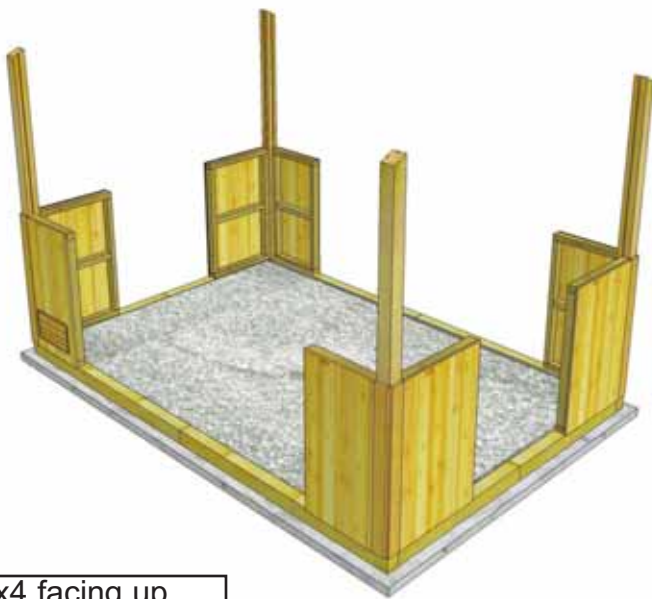

**8.** To complete remaining Post and Side Wall attachments, locate 5 Side Vertical Posts (Part R) and 4 - 25" Wide Side Walls (Part E or F's). On solid, level ground such as a patio or deck lay the pieces down as shown below. You will need at least a 10'x10' area. Place Side Vertical Posts with their 2x3's face down. (Vertical Posts are made using a combination of 2x3's/2x4's). Place Walls with Siding down as well.

2x4 facing up  
2x3 facing down.

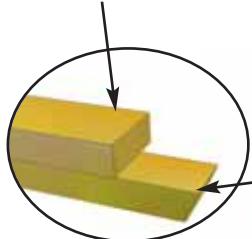

Top

Part R - Side Vertical Posts



Part E or F - 20 1/4" Wide Side Walls



Temporary Post/  
Wall Supports  
(3" high x 2.5" wide)

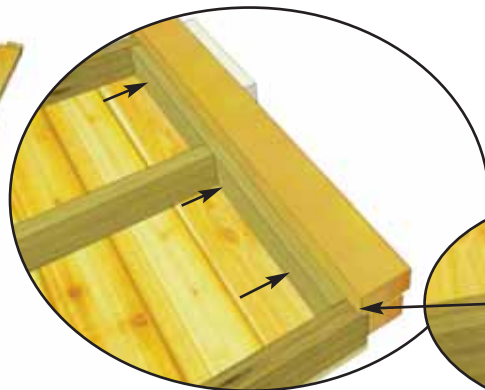
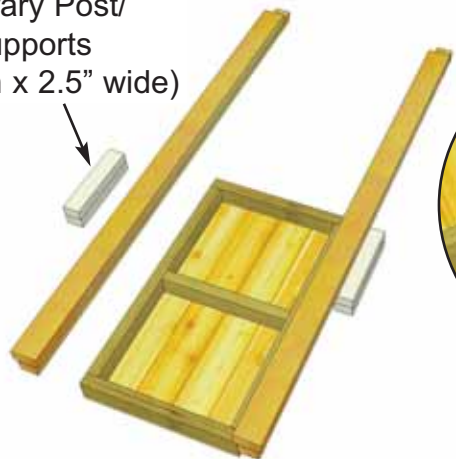

**Important:**  
Use a wood clamp to temporarily hold Post to Wall Framing.

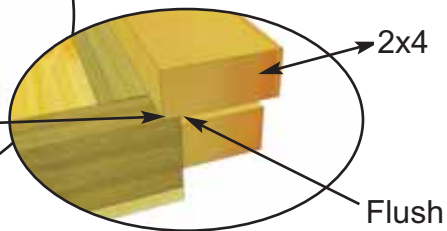

**9.** Position Post R against Wall Framing as shown above. Make sure Post is flush with bottom of wall framing. Locate Temporary Post/Wall Supports (3" high) and place underneath 2x4 edge and touching 2x3 as shown above. Clamp and attach Post to wall framing with 3 - 3". Do both sides.

Temporary Post/  
Wall Support.

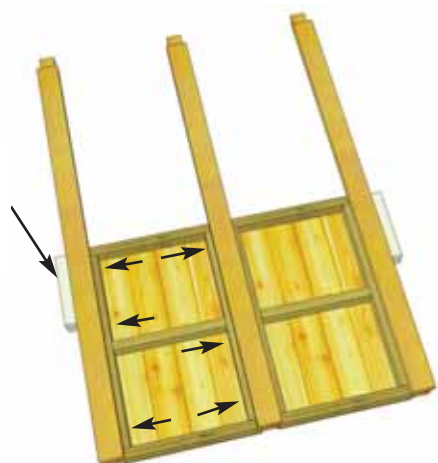

**10.** Repeat **Step 9** until four 20 1/4" wide Side Walls are attached.

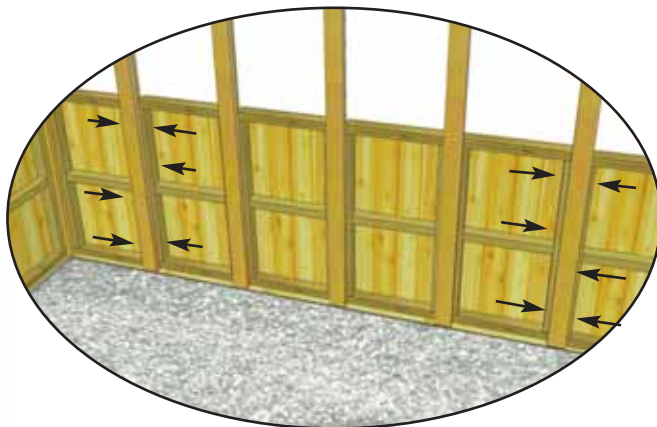
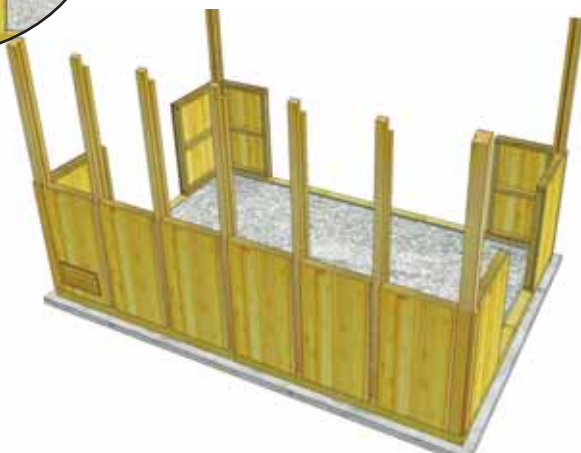
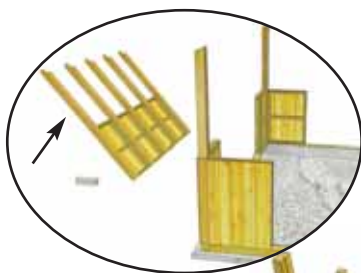

**11.** With a helper, carefully lift up completed wall section and place between corner wall/post sections. Align and attach as per **Step 9**. Be mindful that corner Side Wall bottom framing is flush with bottom of Side Vertical Post.

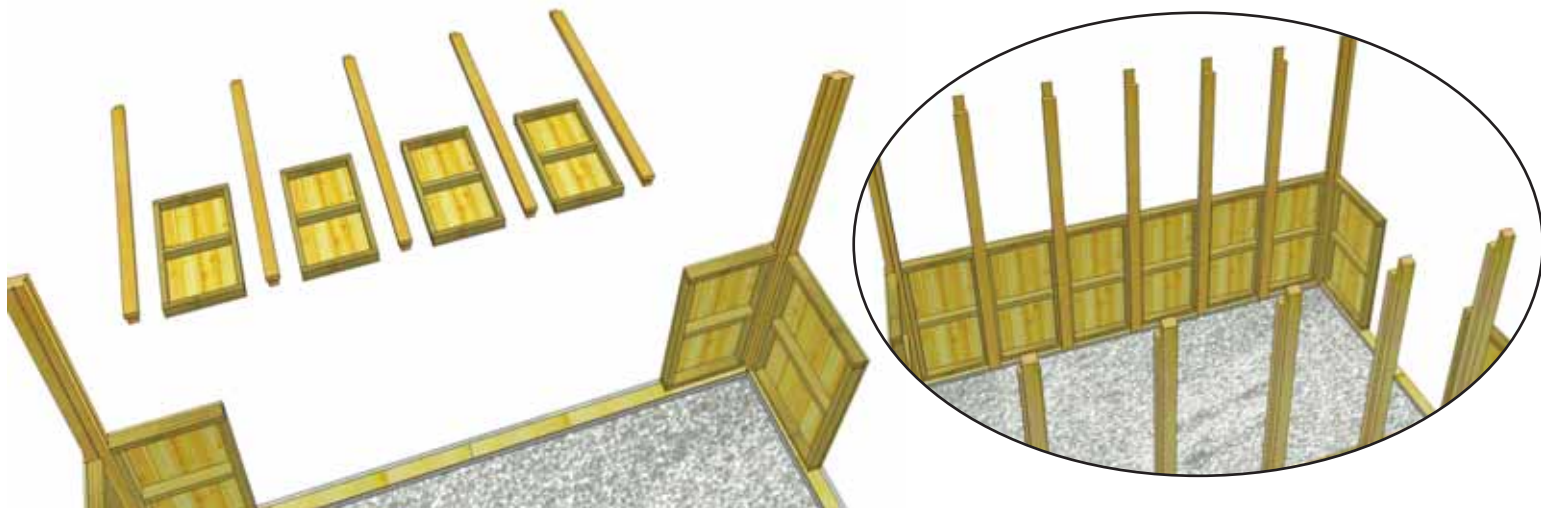

**12.** Complete opposite Side Wall attachments as per **Steps 9-11.**

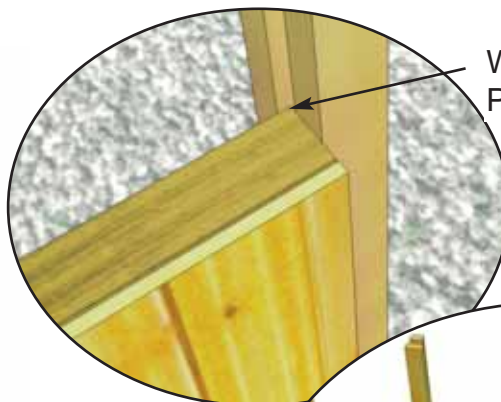
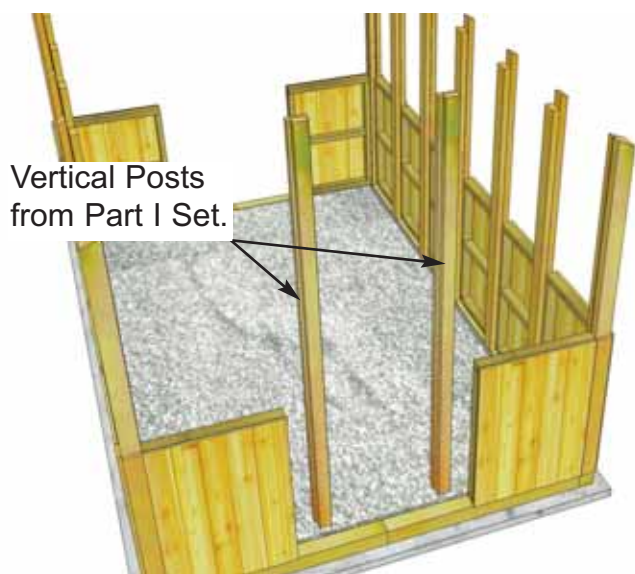

Wall tight against Post. Use Clamp.



**13.** Locate **Part I.** The Doorway / Wall Framing Sets. There are 2 Sets (Front/Rear). Align and install Vertical Posts from the set as per **Step 9.** Install rear side first.

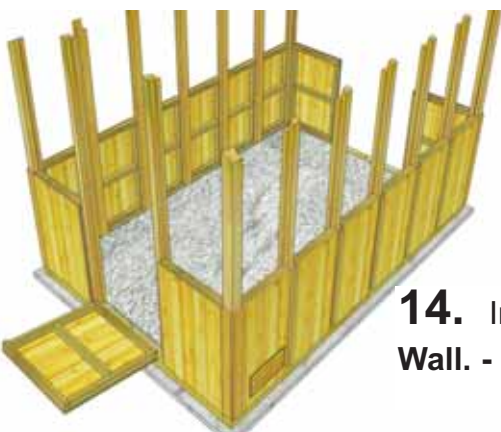

**14.** Install **Part G. (Wide Rear Center Wall. - 35" high)** as per **Step 9.**

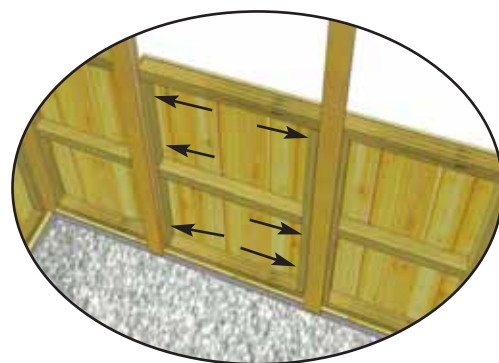

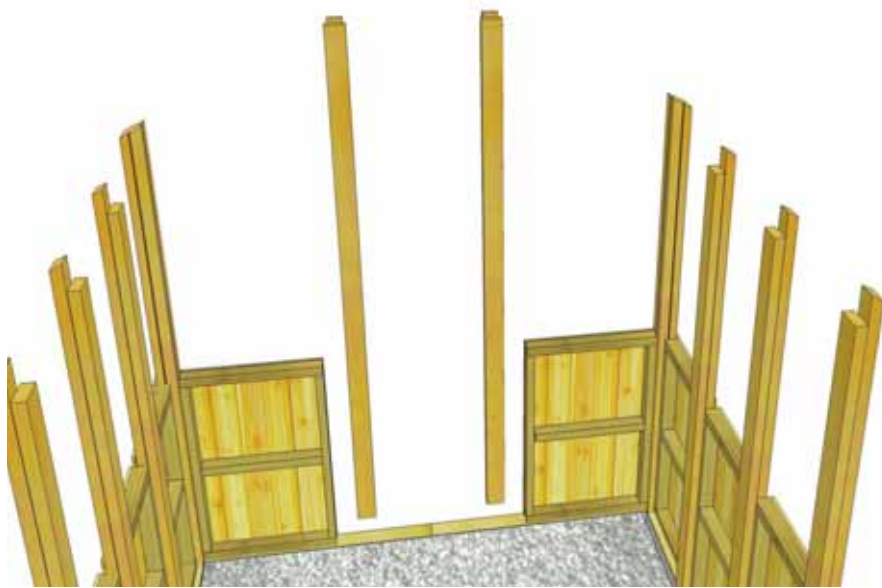

**15.** Install the Vertical Posts from the Front Set of **Part G**. as per **Step 14**.

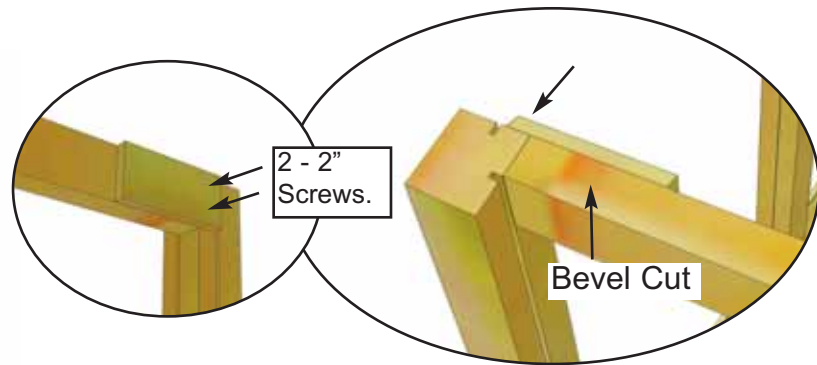
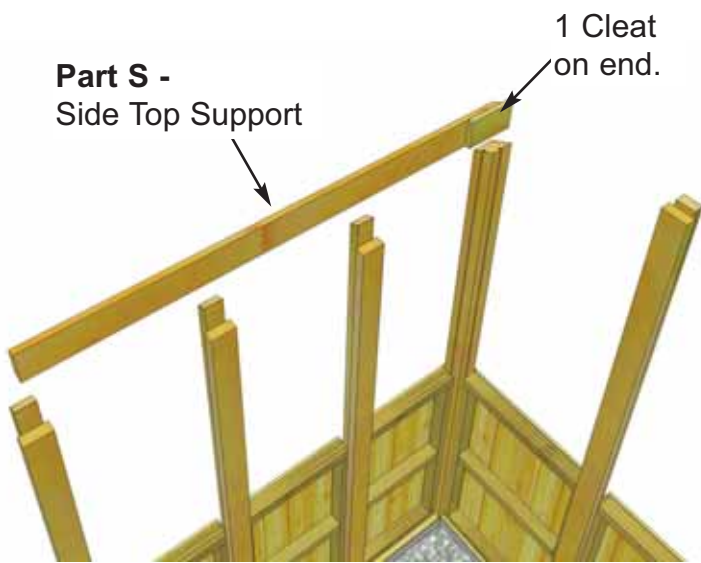

**16.** Locate **Part S - Side Top Supports with a Bevel Edge**. There are 2 pieces per side. Starting with Support with only one Cleat on the end, position on top of Side Wall Posts. Align Cleat end tight against Corner Post and attach with with 2 - 2" screws as shown above.

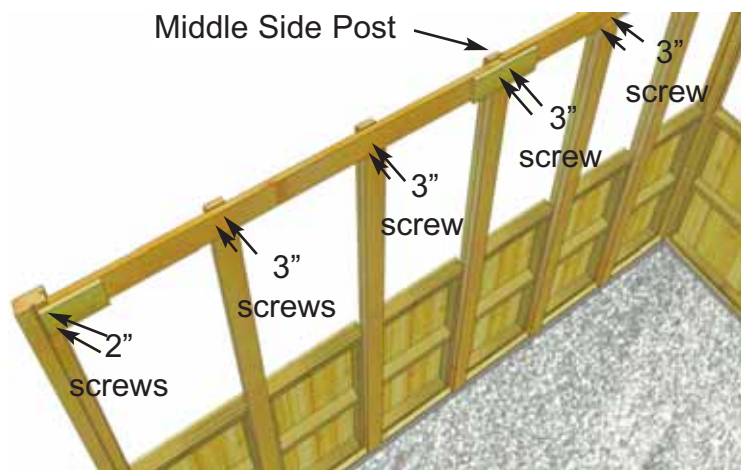
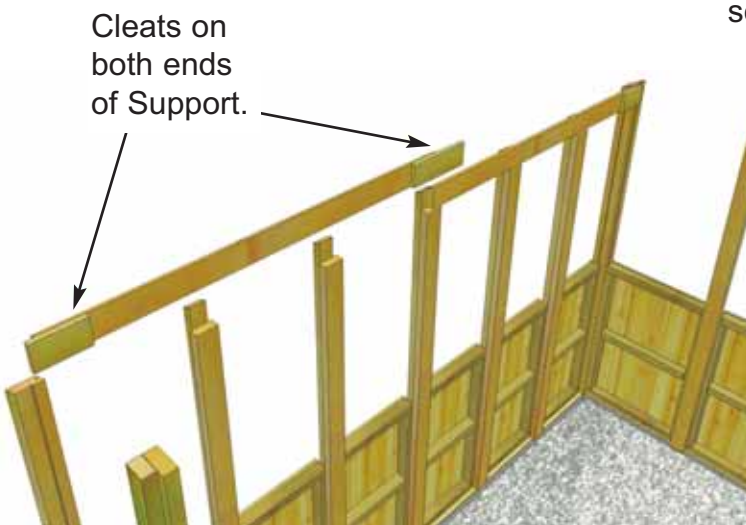

**17.** Position and attach Side Top Support with Cleats on both ends as per **Step 16**. Attach Corner Post(s) End first with 2 - 2". Align Supports equally on middle Side Post and attach with 2 - 3" screws. Attach remaining interior Posts with 2 - 3" screw as shown above.

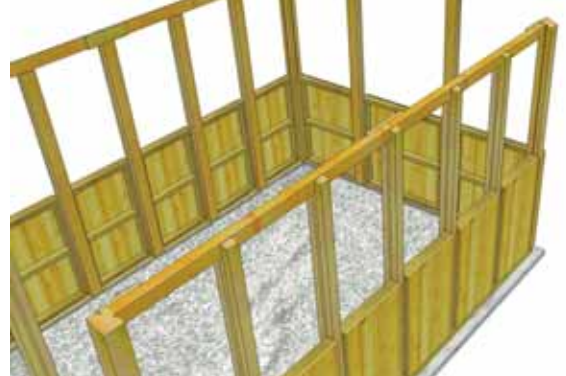

**18.** Repeat **Steps 16-17** to complete opposite Side Top Support pieces.

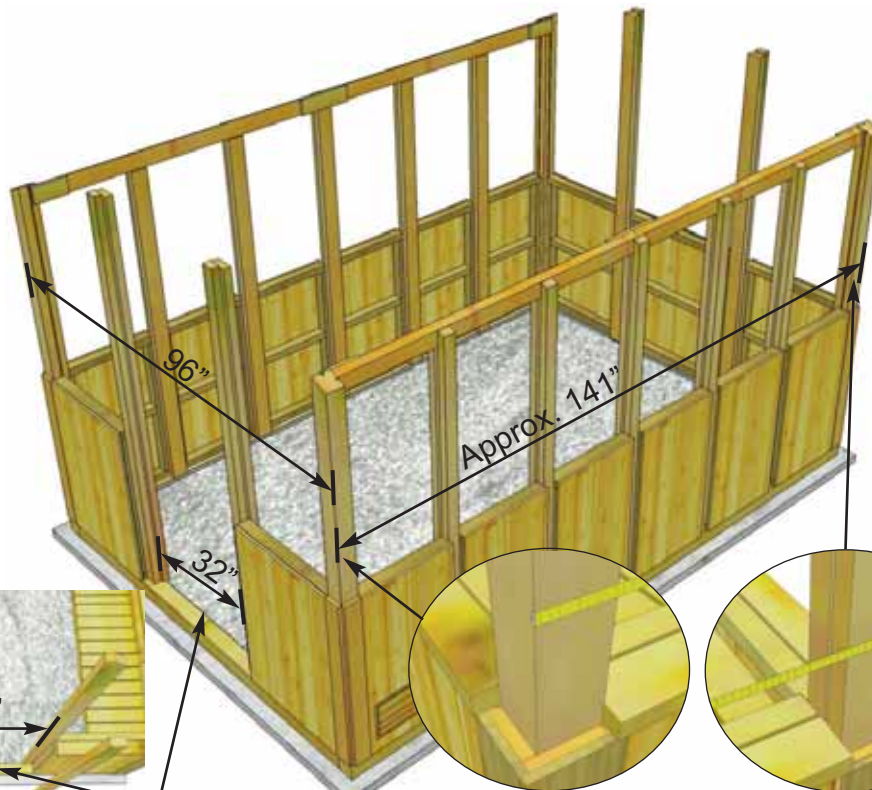

**19.** Measuring from the outside of Corner Post 4x4's, your Greenhouse should have a footprint ideally of **96" wide x 141" deep**. There can be small tolerances when connecting post/walls together resulting in a variation on the depth of approx. 1/2".

If using Wood Foundation Posts supplied, screw walls down onto foundation with 2 - 3" screws per panels.

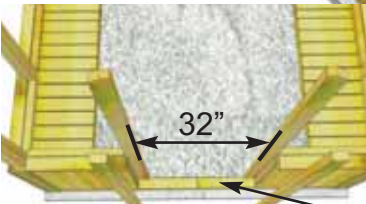

Doorway Opening = 32" from 2x4's.

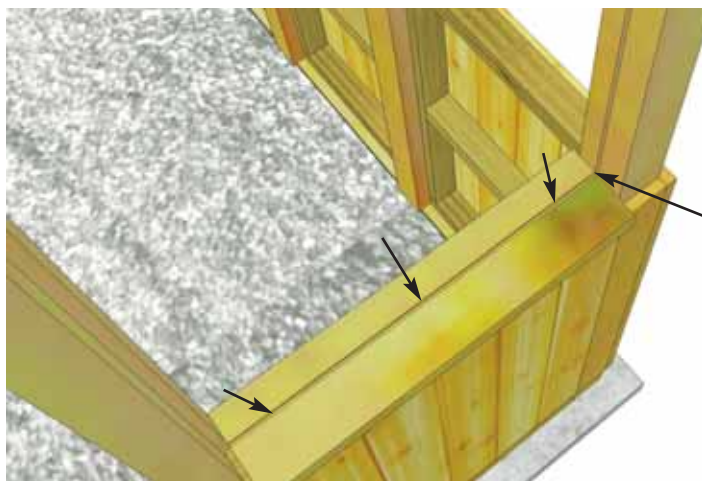
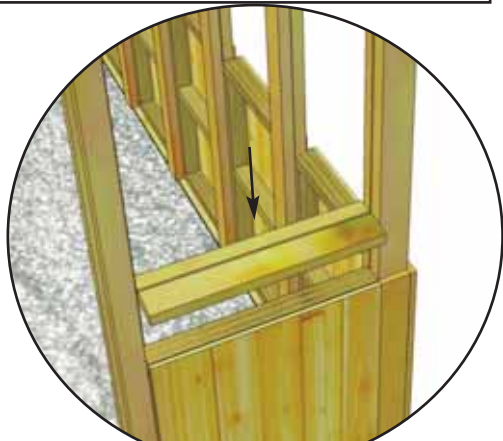
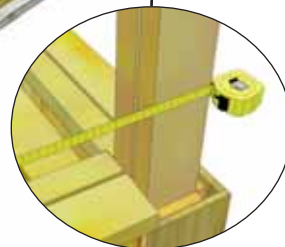
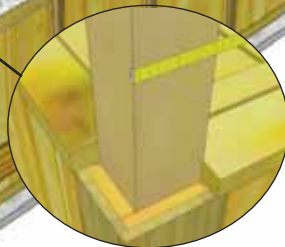

Line Dado cut of Cap with Dado cut of Corner and Doorway Post.

**20.** Locate **Part J - Front Wall Top Cap - 1 1/2" x 5 1/2" x 25 3/8"** - Right Side. Position on top of Front Wall so dado cut of Cap lines up with dado cut of Corner and Doorway Post. Note - the cap has a slight bevel cut that will be facing to the outside to direct water away from the Greenhouse. Attach with 3 - 3" screws in dado cut line on slight angle. Sink screw head below wood so Polygal window sits down in the dado cut.



**21.** Repeat **Step 20** to attach Left Side Front Wall Top Cap.

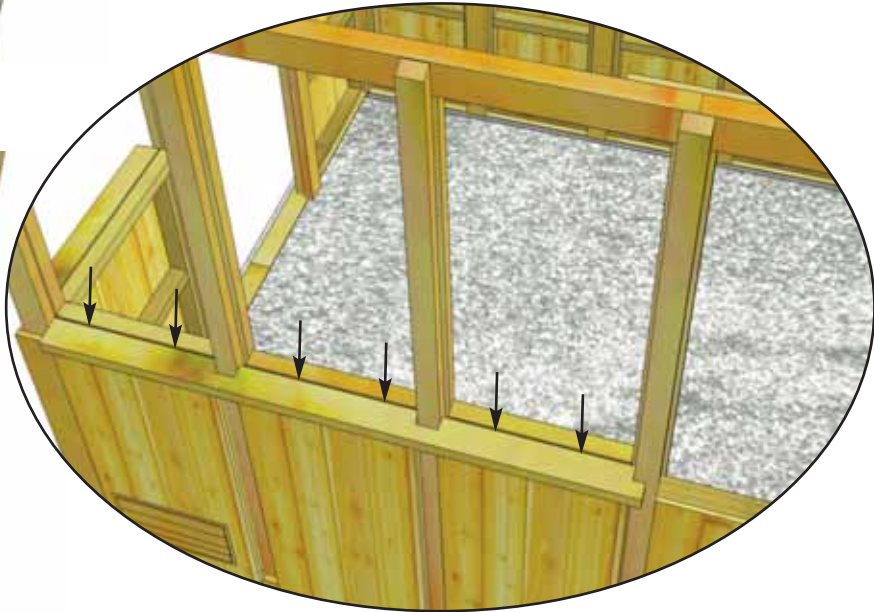
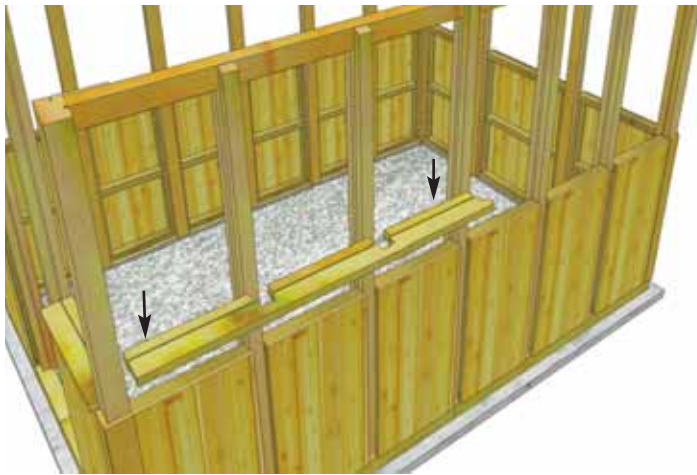

**22.** Locate **Part T - Side Wall Top Caps - 1 1/2" x 5 1/2" x 66 3/4"**. Position and attach as per **Step 21**. The Cap is designed with tolerance and gaps will appear around the notches. Later, caulking may be applied to seal these gaps.

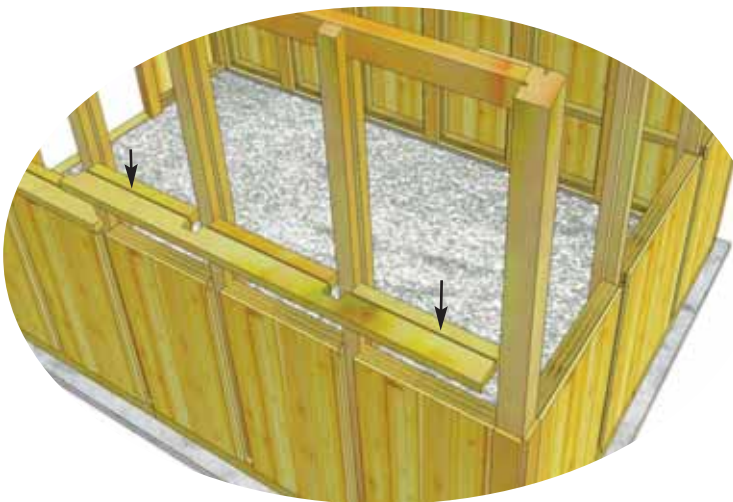

**23.** Complete Side Wall Top Cap on one side. Depending on your footprint measurement, a gap of 1/8" to 1/2" could result where Caps meet in the middle. You may use caulking later to seal the gap.

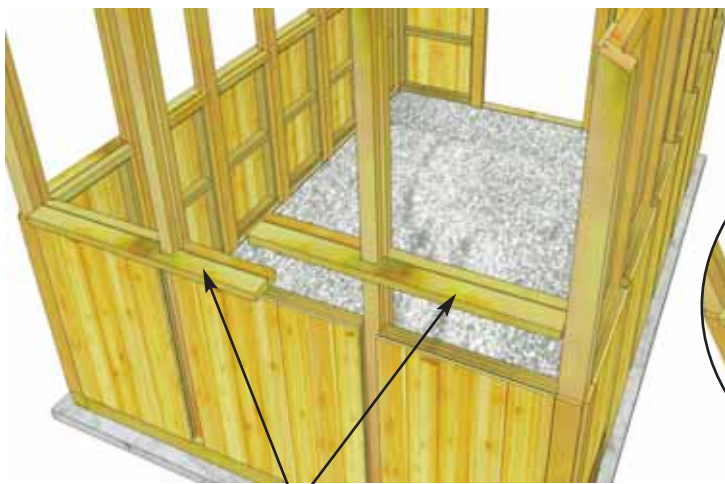

Rear Wall Top Caps



**24.** Locate **Part H - Rear Wall Top Caps - 1 1/2" x 5 1/2" x 44 1/2"**. Position and attach as per **Step 21**. Once again, the Cap is designed with tolerance and gaps will appear around the notches. Later, caulking may be applied to seal these gaps. Complete remaining Side Wall Top Cap attachments as shown to the left.

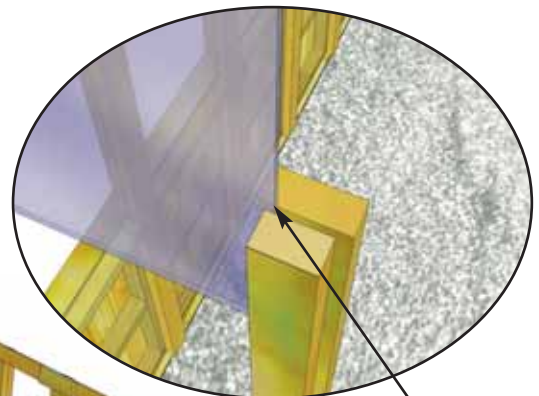

position in gap.

**Important:**  
Install Polygal Windows in sequence outlined in this manual.

Outside Angel Cut Polygal Window

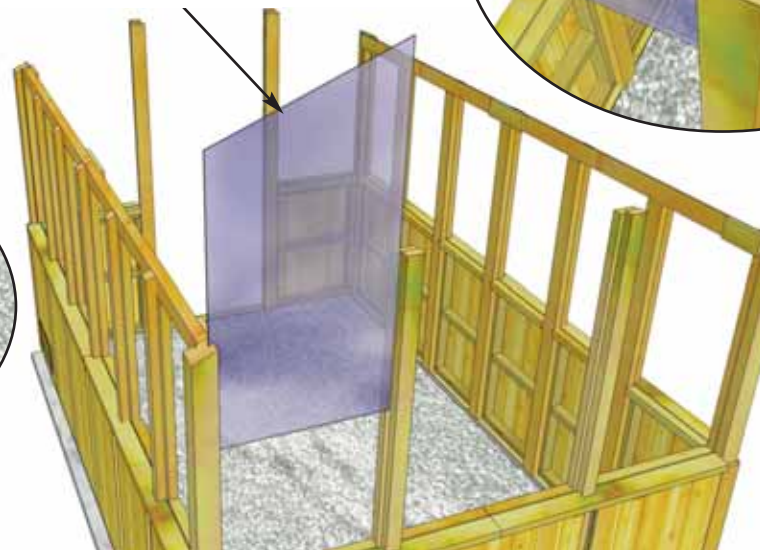

position in dado cut.

**25.** Locate **Part K - Outside Angle Cut Polygal Windows - 26 1/2" wide**. Peel protective plastic layer off first sheet noting correct side out. On a step ladder, lift window up and position in the top Corner Post dado cut and in the gap of the Doorway Post. Slide down.

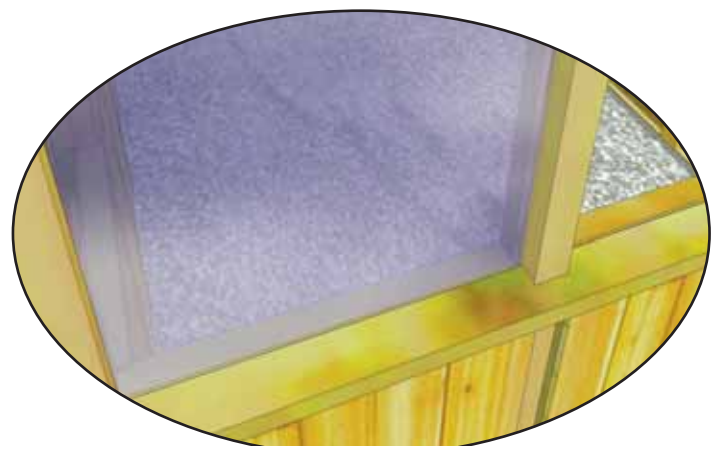
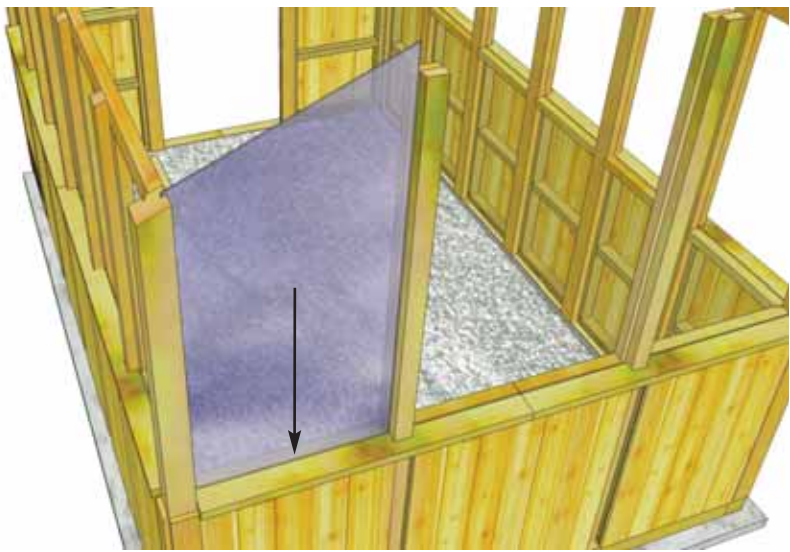

**26.** Slide **Window** down into the dado cut of the Top Cap.

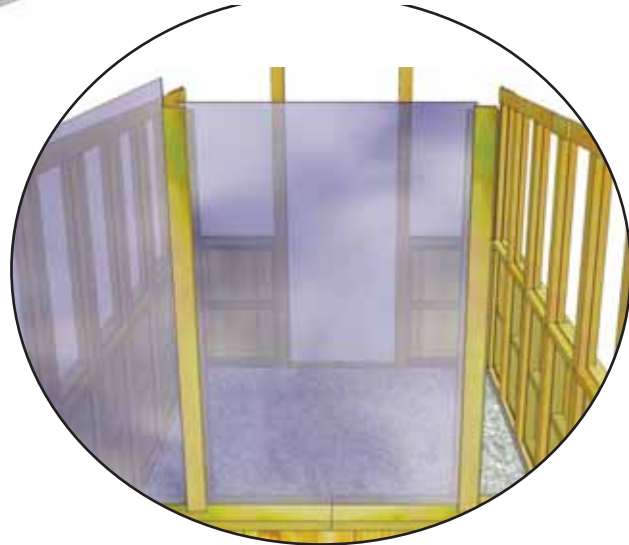
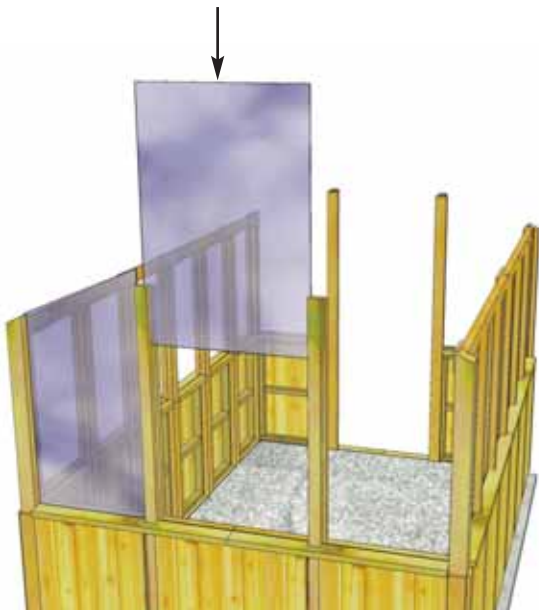

**27.** Locate **Part L - Rear Center Polygal Window - 33 3/4" wide**. Once again, peel protective plastic layer off first and note correct side out. On a step ladder, lift window up and position between gap of Doorway Posts. Slide down and position as per **Step 26**.



**28.** Locate a second **Part K - Outside Angle Cut Polygal Window - 26 1/2" wide**. Position as per **Step 25-26**.

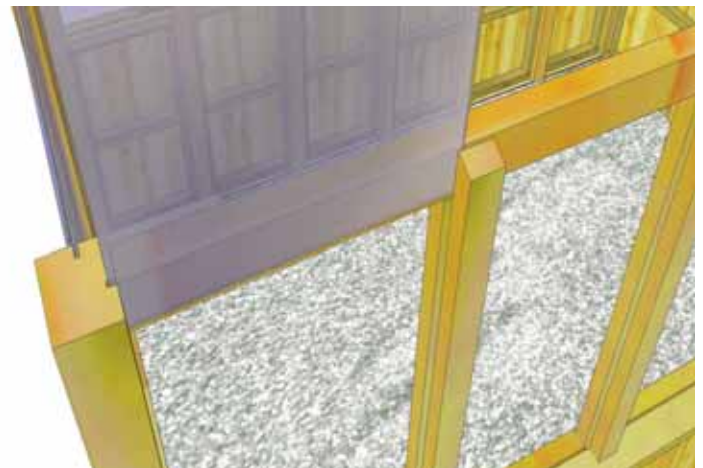

**29.** Locate **Part W - Side Polygal Windows - 21" wide x 37" long**. Position as per **Step 25-26**.

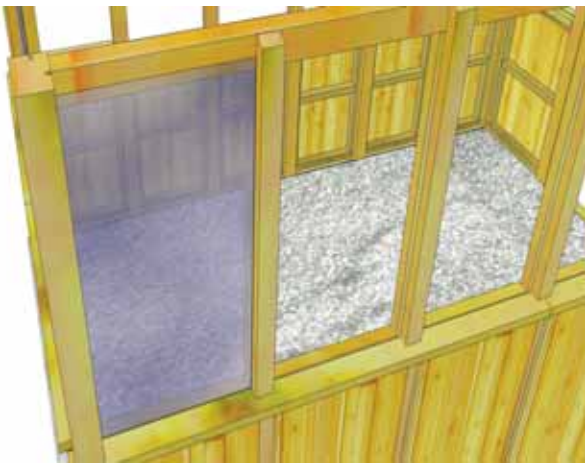

**30.** Make sure the **Window** Slides down into the dado cut of the Top Cap.  
 Position remaining corner Polygal windows as shown to the right. (3 outside Side Windows and 2 front Angle Cut Windows.)

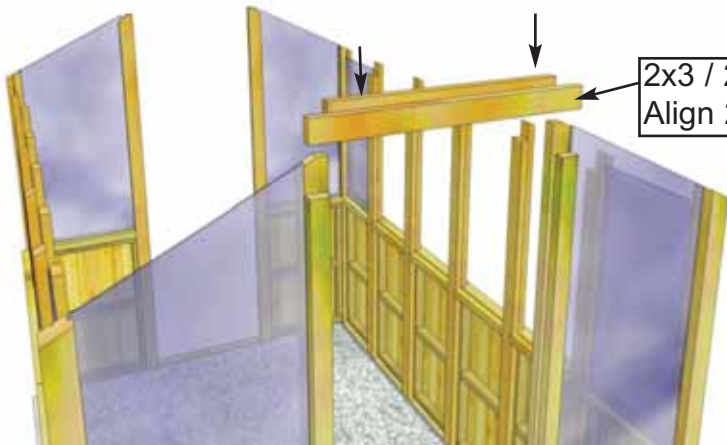
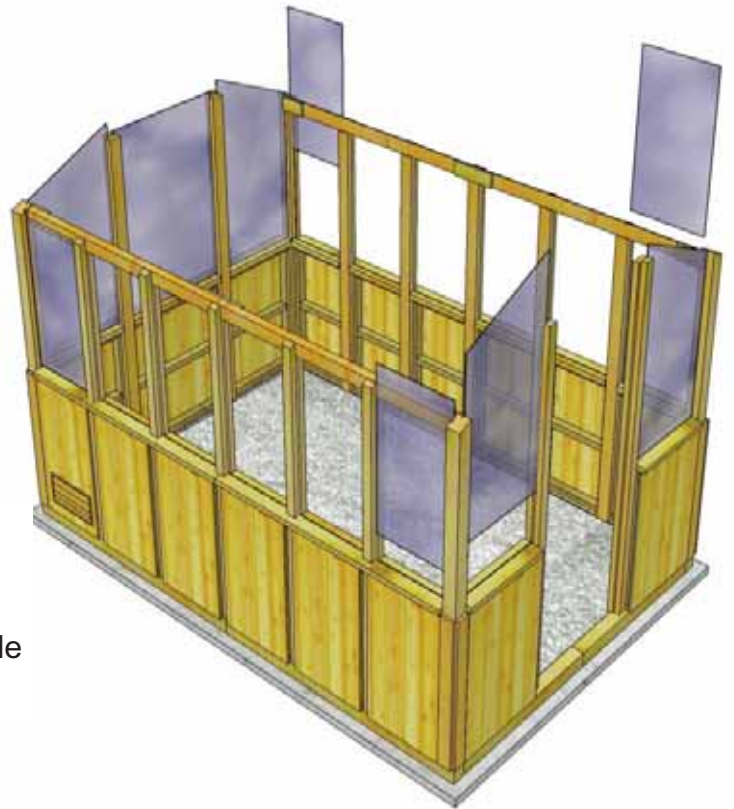

2x3 / 2x4 Top Cap.  
 Align 2x3 to outside.

2x4 of top cap will sit between doorway framing. Screw 2x3 to frames.

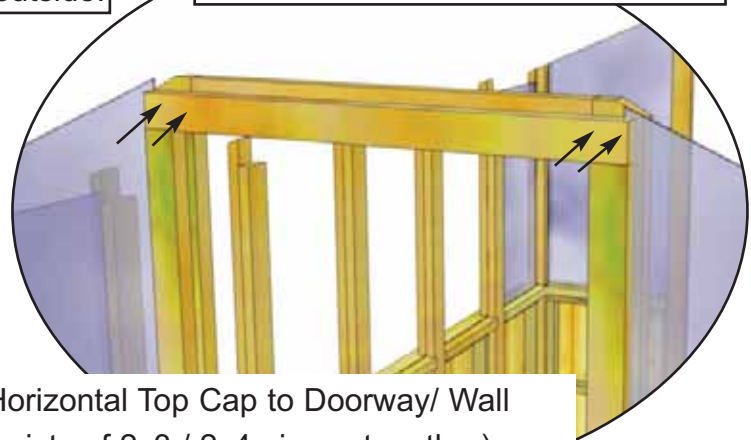

**31.** Position, attach Horizontal Top Cap to Doorway/ Wall Framing Set - (Cap consists of 2x3 / 2x4 pieces together).  
**Part I - 37 7/8" long.** Cap will between Doorway Framing. Use 4 - 3" screws to secure from front 2x3 into frames. Complete both front and rear Caps.

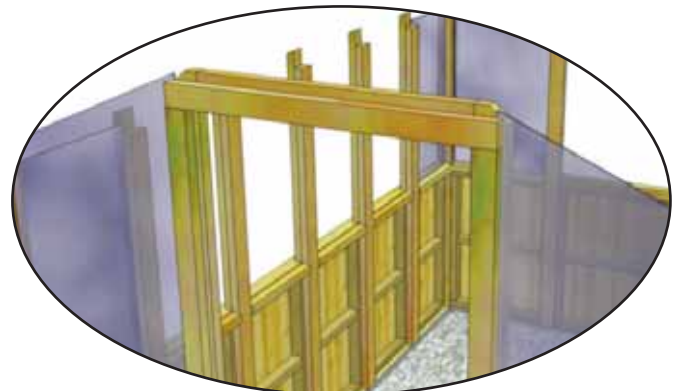



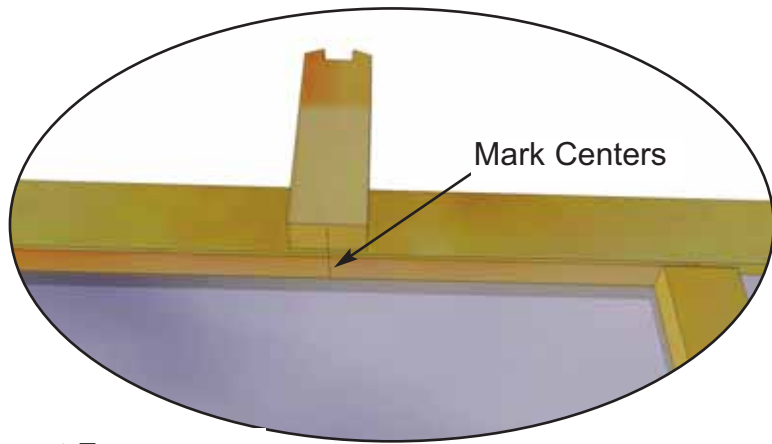
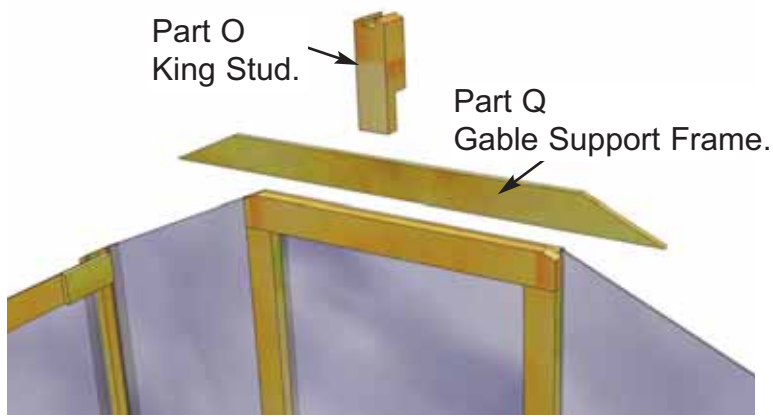

**32. Locate Parts O & Q - King Stud and Gable Support Frame.**

Using a tape measure, mark centers on bottoms of Horizontal Top Cap / King Stud / Gable Support Frame. Center Gable Support on Cap and tack together only with 2 - 2" screws. Center King Stud on Support Frame and tack also with 1 - 3" screws. Complete both front and back pieces. In **Step 43.**, some adjustment may be required. Completely attach then.

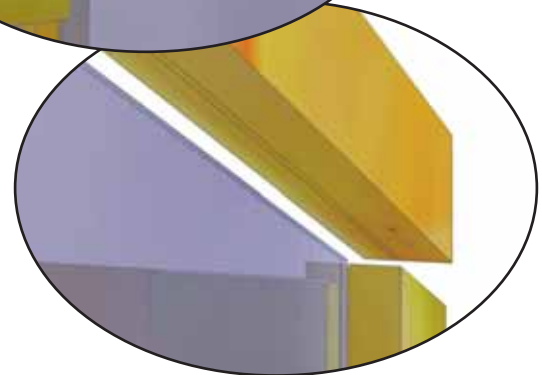
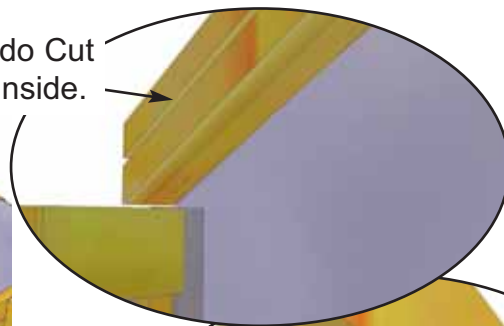
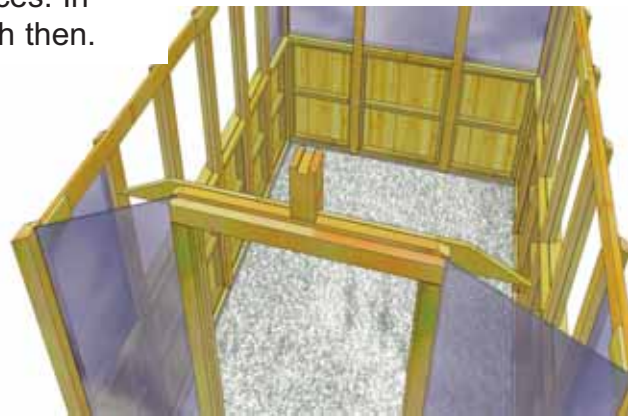
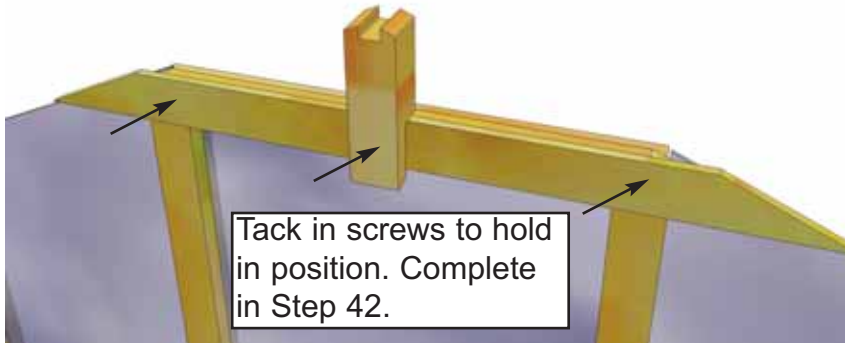

**33. Locate Part N - Outside Roof Rafters - 3 1/2" x 3 1/2" x 51".** There are Left and Right Rafters. Starting with a Right Rafter as configured above, lift up and position on Post.

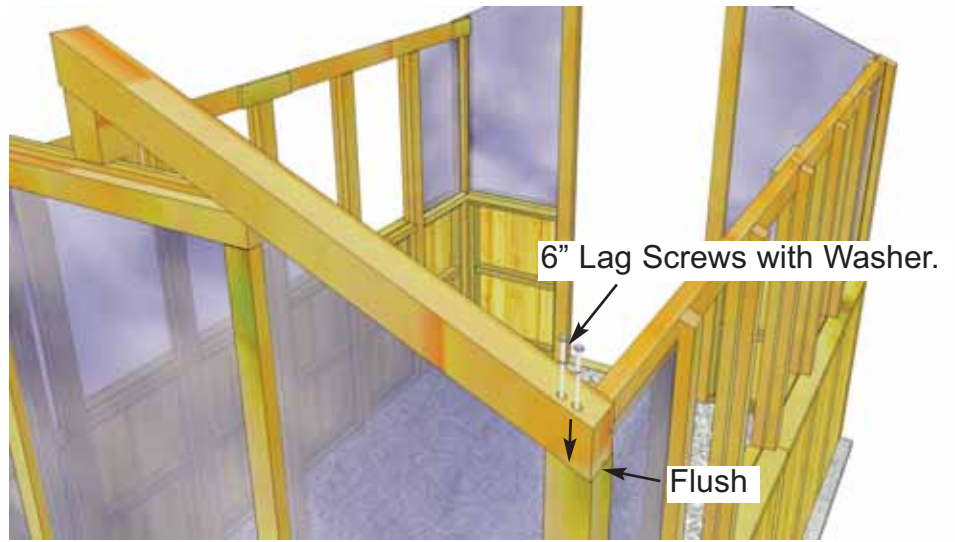
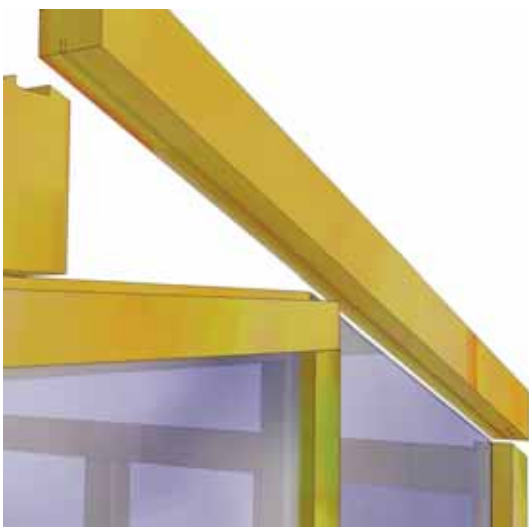

**34.** Position Rafter so end is flush with Corner Post and Outside Polygal Angle Cut Window slides into dado cut of Rafter. When orientated correctly, start 2 - 6" Lag Screws with 3/8" Washer with a hammer and tighten with 9/16" socket.

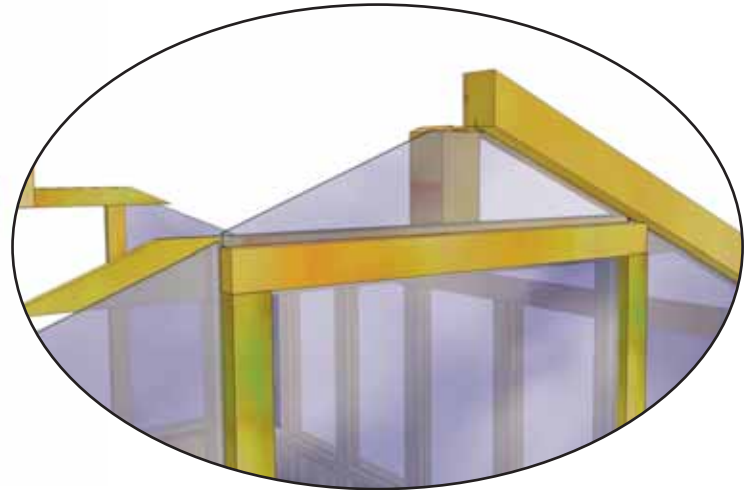
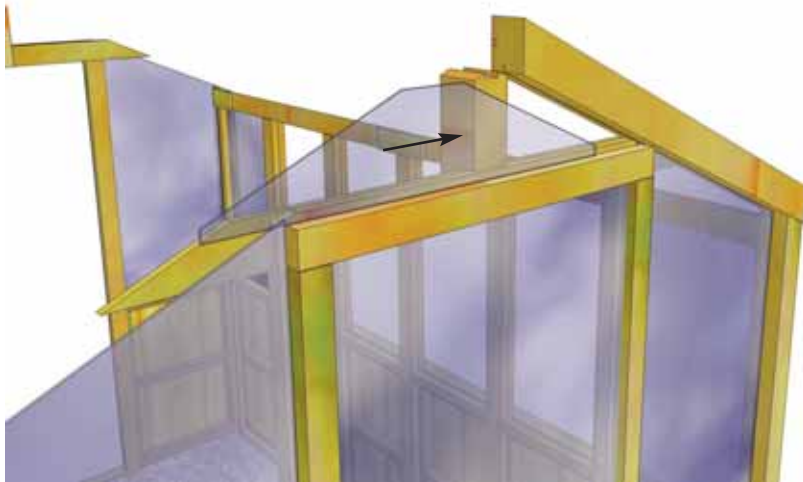

**35.** Locate **Part M - Top Triangular Polygal Windows**. Slide Window in Top Cap gap and into dado cut of Rafter.

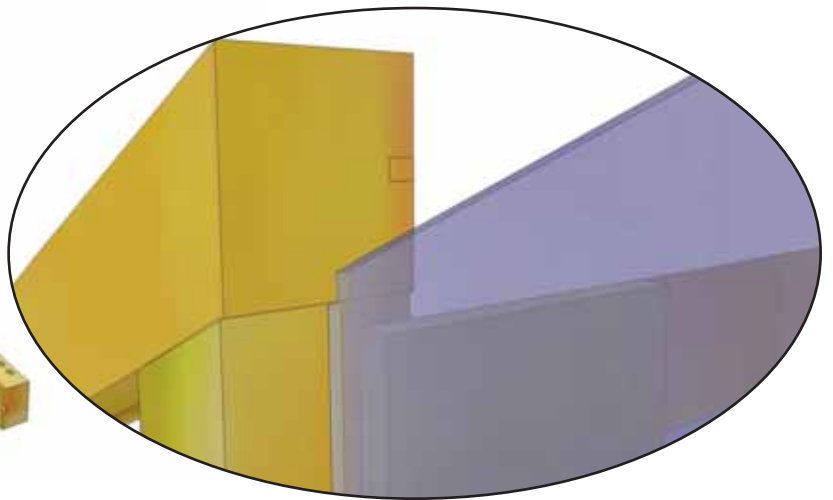
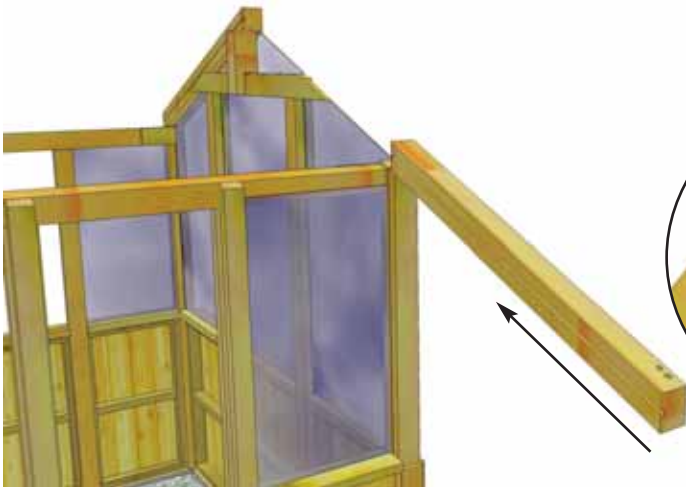

**36.** Locate Left Side Rafter and orientate as shown above. Once Outside Polygal Angle Cut Window is sitting in dado cut of rafter, carefully slide Rafter up.

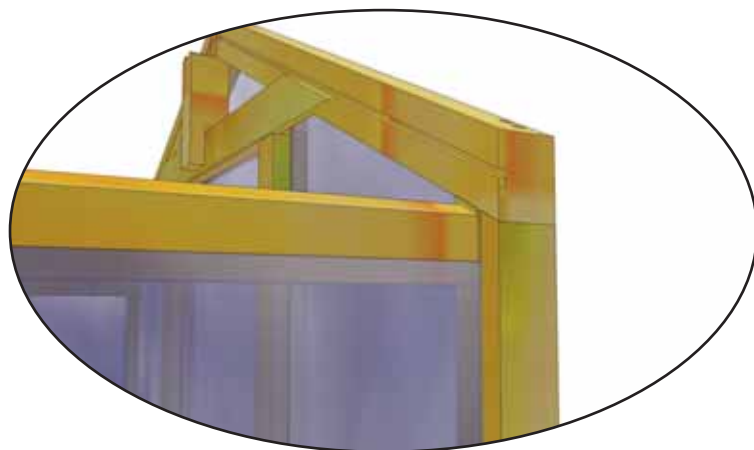

**37.** Carefully Slide Rafter up until end of Rafter is flush with Post as shown above. Make sure Angle Cut Window and Triangular Window stays in dado cut of Rafter.

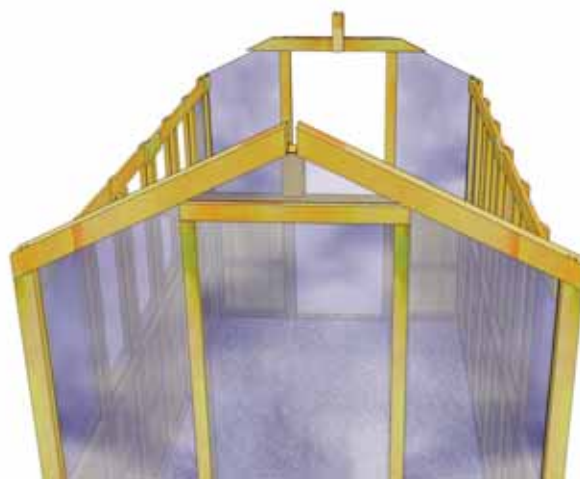
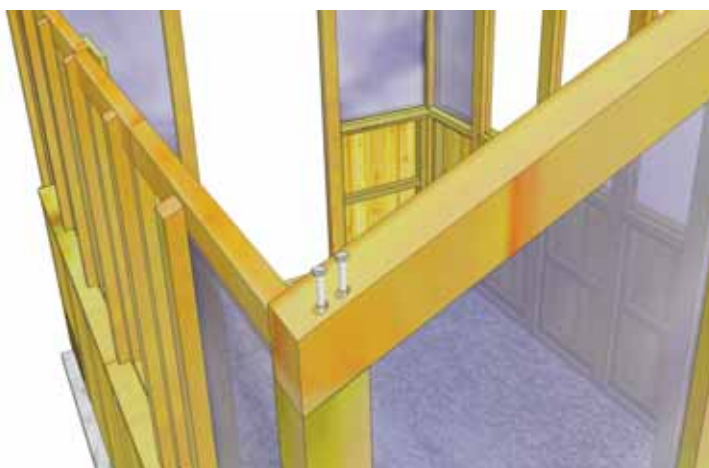

**38.** When Rafter is orientated correctly, start 2 - 6" Lag Screws with Washers with a hammer and tighten with 9/16" socket. From the inside, attach Gable Support Frame to Rafters with 4 - 1 1/4" screws. See illustration below.



Rear Wall shown with Rafters, King Stud and Gable Support Frame configured correctly.

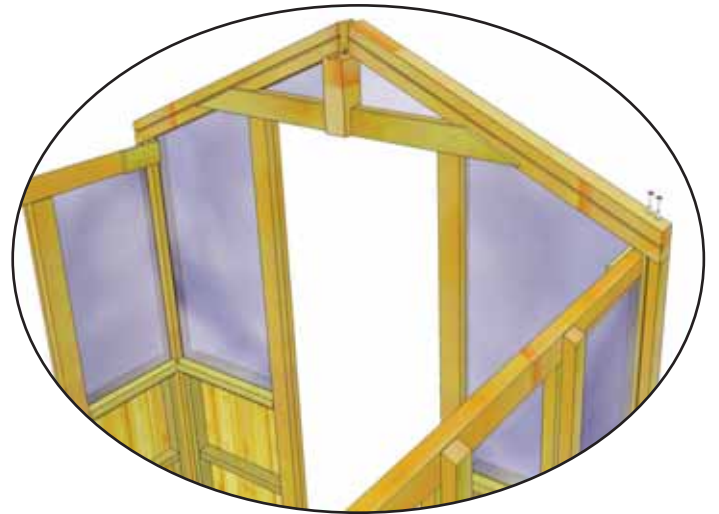

**39.** Complete Front Outside Roof Rafters and Triangular Polygl Window as per **Steps 33 - 38.**

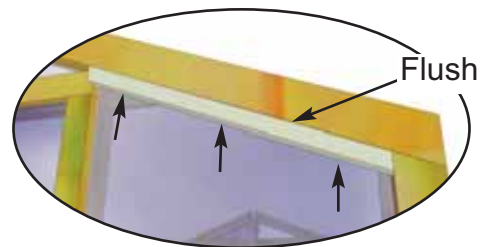

**40.** Attach **Part OO - Exterior Rafter / Doorway Supports - 1 1/2" x 1 1/2" x 27 1/2"** underneath and flush with Outside Rafters. Use 3 - 3" screws per piece to secure. Complete front and rear pieces.

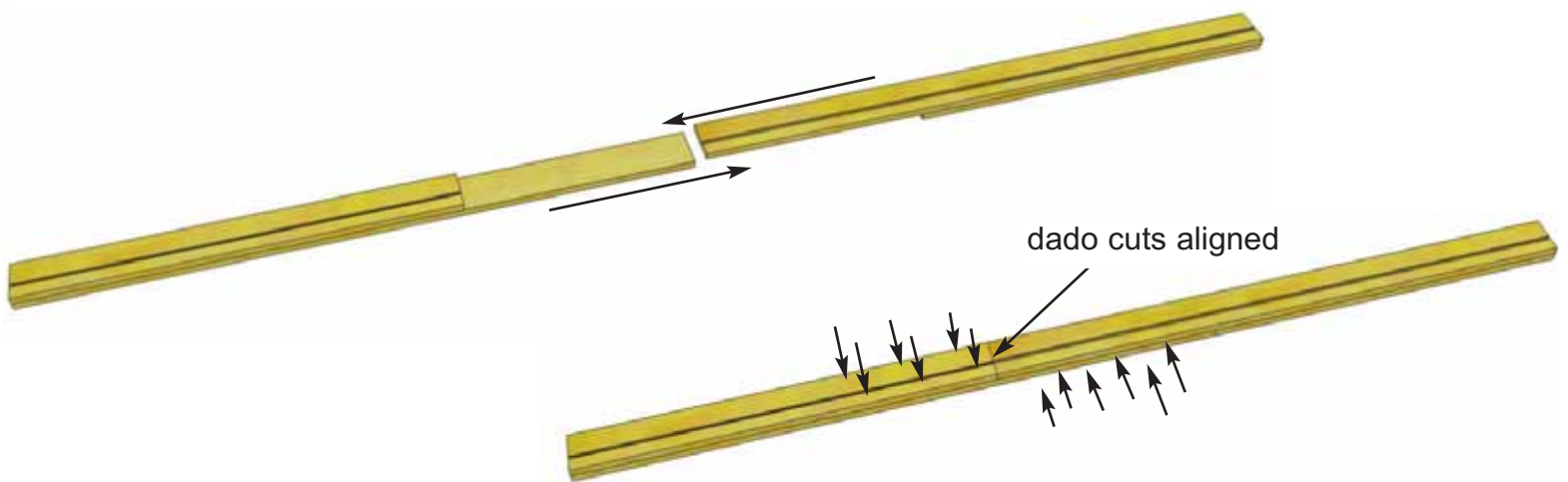

**41.** Locate **Part P - Roof Ridge Boards - 2" x 5 1/2" x 83"**. There are 2 pieces that need to be fastened together. Aligning dado cuts and attach with 6 - 2" screws per side.

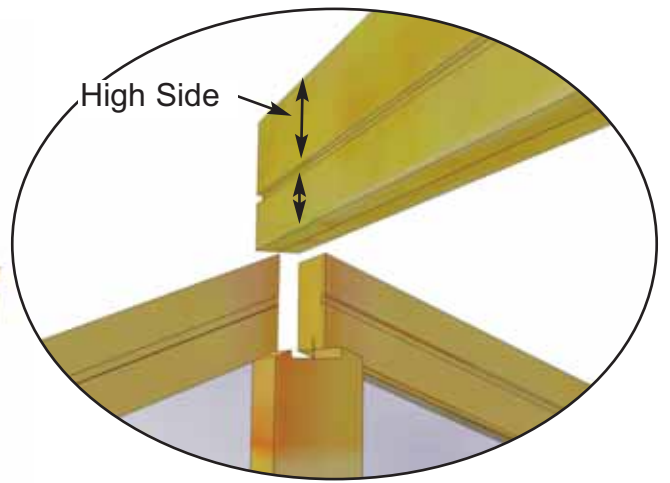

**42.** Before installing completed Ridge Board, note that dado cut is off center. Orientate Ridge Board with high side to top before lifting. See illustration above.

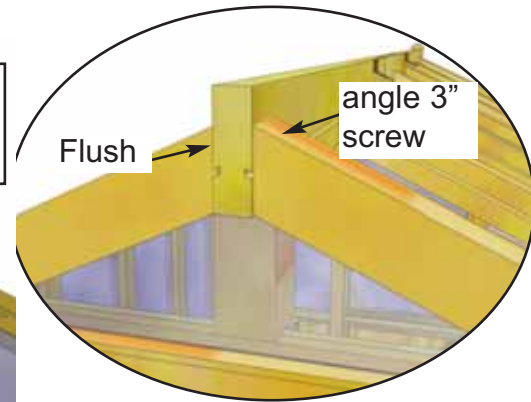
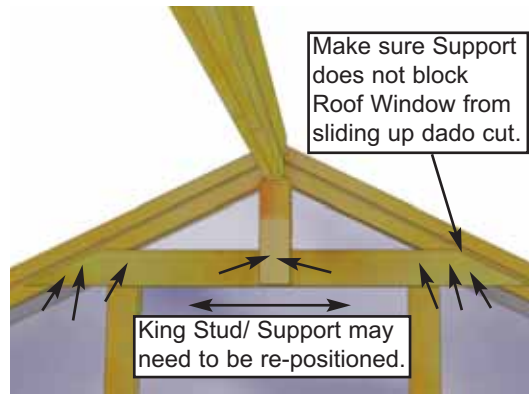
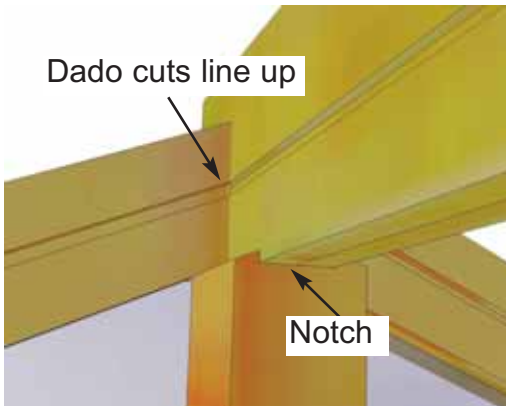

**43.** Drop Ridge Board into King Stud notch. Dado cut of Ridge Board should line up with dado cut of Rafters. From outside, Ridge Board ends should be flush with outside of Rafters. King Stud / Gable Support Frame may need to re-positioned in order to accommodate the Ridge Board correctly. If so, undo tacked in screws and position to fit. Complete securing using 6 - 2" in Support and 2 - 3" screws in King Stud. Secure Rafters to Ridge Board by angle screwing from Rafter into Ridge Board as shown above with 2 - 3" screws per Rafter.

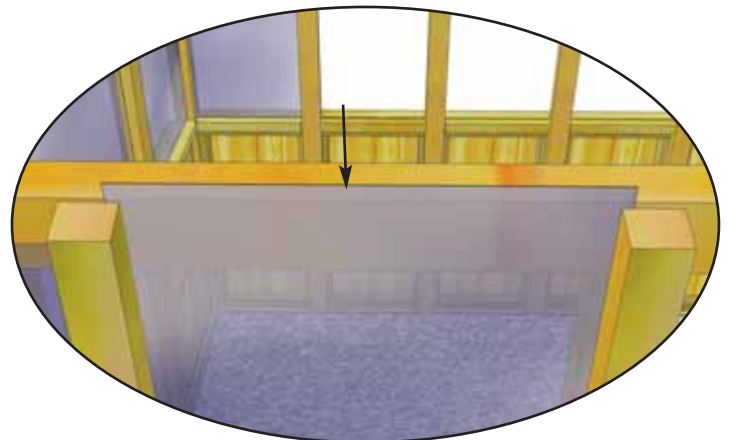
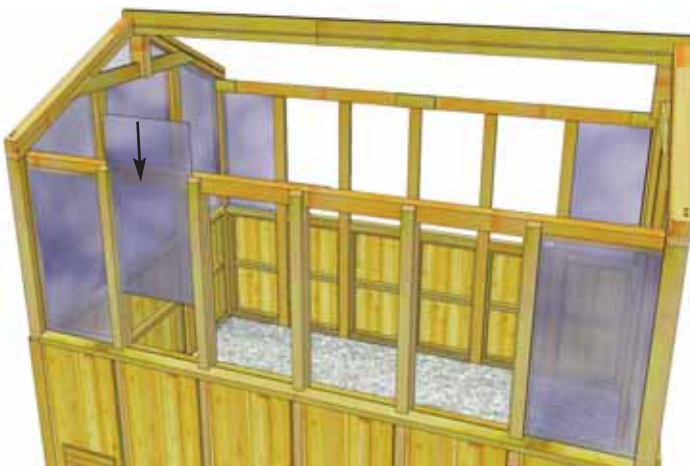

**44.** Install remaining **Part W - Side Polygal Windows - 21" wide.** Position as per **Step 25-26.** **Correctly orientate Polygal Windows as per instructions on the Window's protective sheathing.**

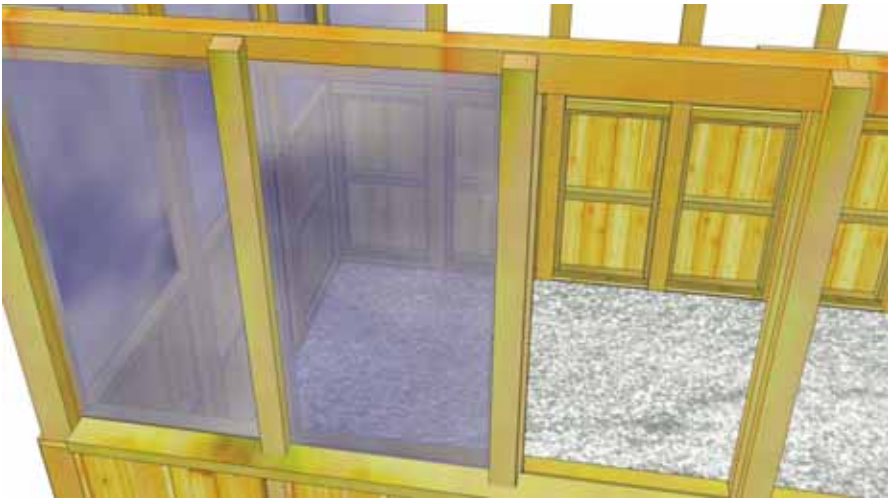

**45.** Once all Side Windows are installed. Caulk Window / Wall Top Cap seam. Work around the entire Greenhouse. Gaps in Wall Top Caps can also be caulked at this time. No need to caulk sides or top at this time.

Rafter Template Spacer - 20 3/16".



Spacer tight against Outside Rafter  
Spacer tight against 2x3.

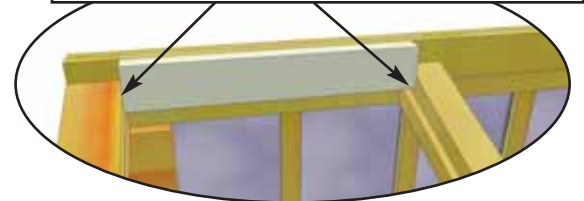

Align dado  
cuts with gap  
in Rafter.

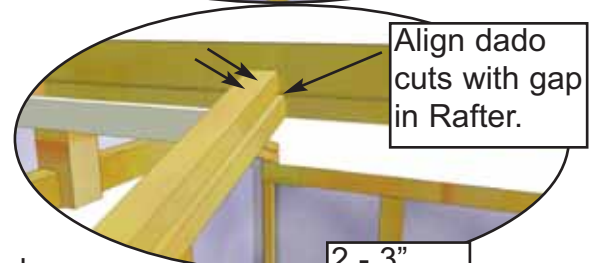

2 - 3"  
Screws

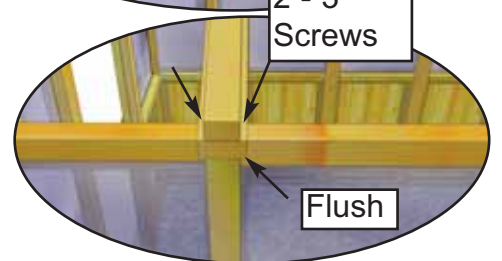

Flush

**46.** Locate **Part U - Roof Rafters - 3 1/4" x 3 1/2" x 50 3/4"** and **Rafter Template Spacer - 20 3/16"**. With Spacer aligned tight against outside Rafter, position Rafter so dado cut of Ridge Board is aligned with gap in Rafter and tight against 2x3 edge of Rafter. Angle Screw to Ridge Board with 2 - 3" Screws. At bottom, align with Spacer. Rafter end should sit flush with outside of Side Post. Screw Rafter to Side Top Plate Support with 2 - 3" screws.

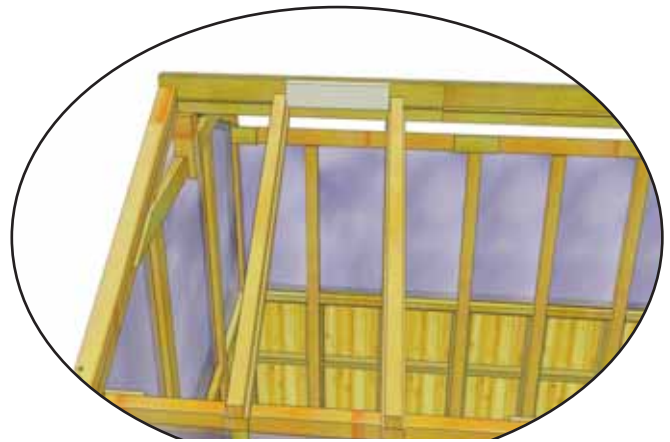

**47.** Install second **Part U - Roof Rafter using Rafter Template Spacer**. Align Spacer tight against Rafter's 2x3 edge. Position Rafter so dado cut of Ridge Board is aligned with gap in Rafter and tight against 2x3 edge of new Rafter. Attach as per **Step 46**.

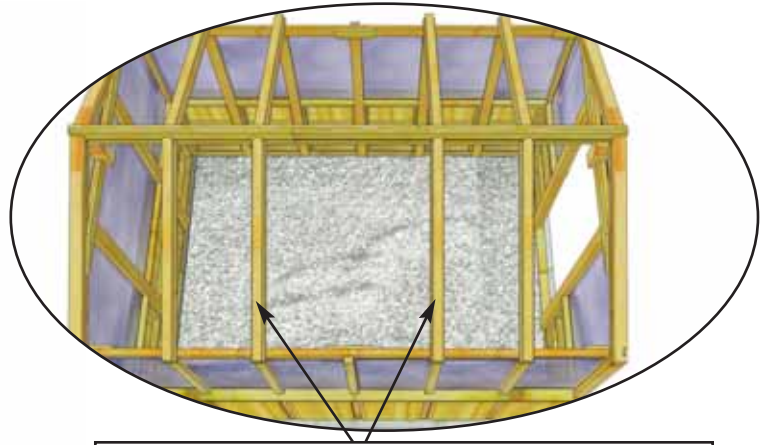
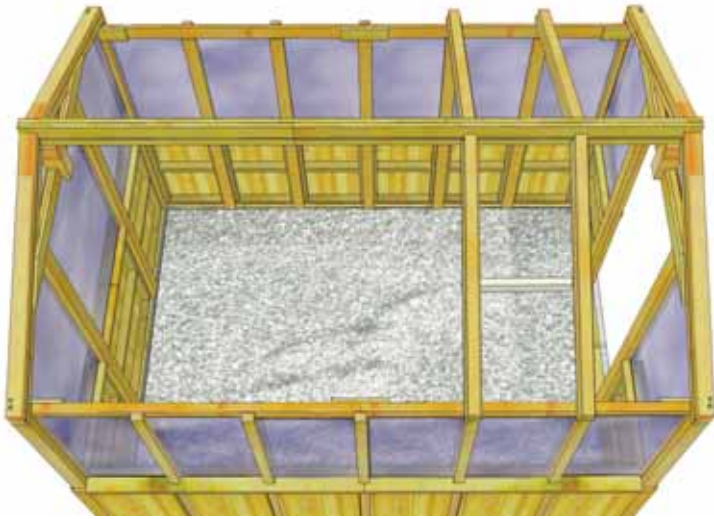

Confirm correct Rafter location by placing **Part Z - Vent Hinged Window** or **Part V - Inside Vent Framing Support** on Rafters. Window must open and shut freely. Rafters may need slight adjustments.

**48.** Install Rafters as illustrated above and to the right as per **Steps 46 & 47**.

**Part V - Inside Vent Framing Support**

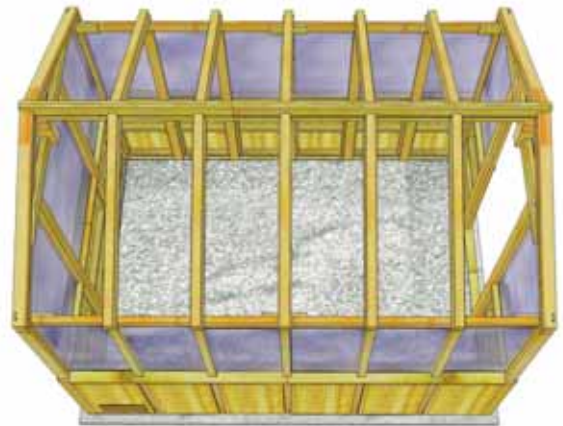
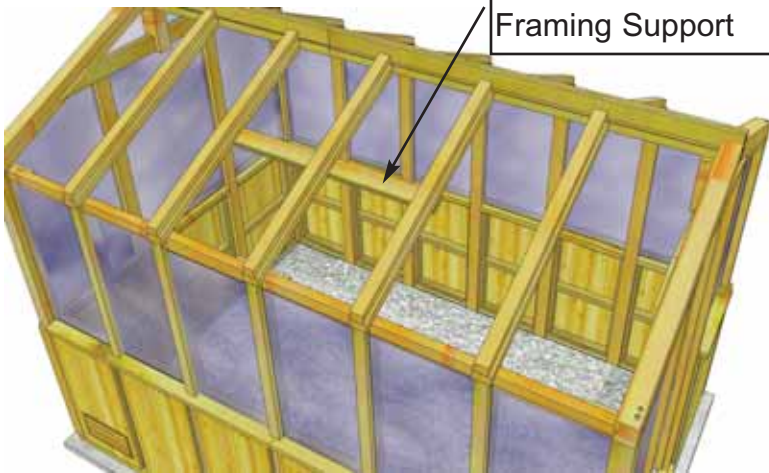

**49.** Install Center Rafters to complete Rafter section as illustrated above and to the right as per **Steps 46 & 47**. Confirm Center Rafter location using **Part Z** or **V**. Adjust if necessary.

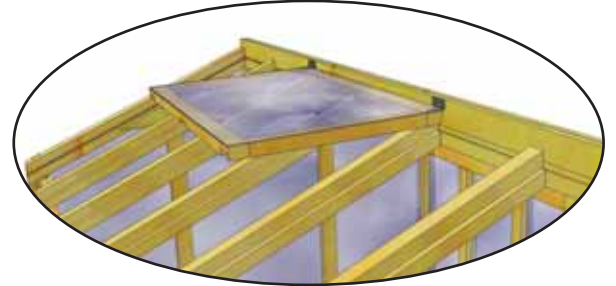
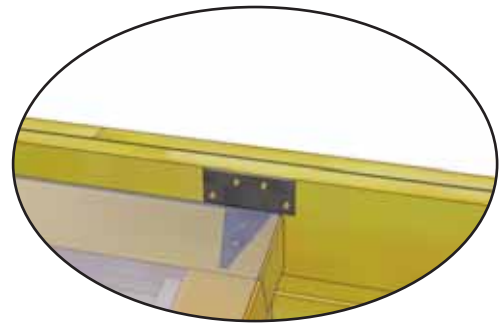
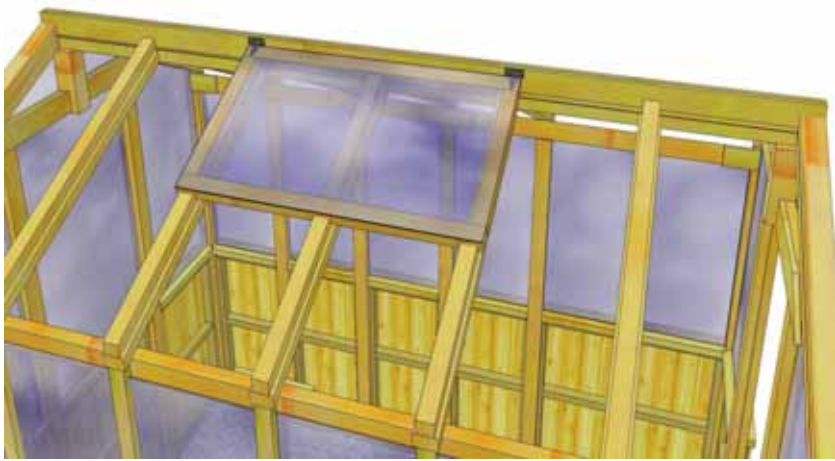

**50.** Standing on a ladder from the inside, position and attach **Part Z - Vent Hinged Window** to Ridge Board. Prior to attaching, confirm Window can move up and down freely. Attach with 3/4" Black screws.

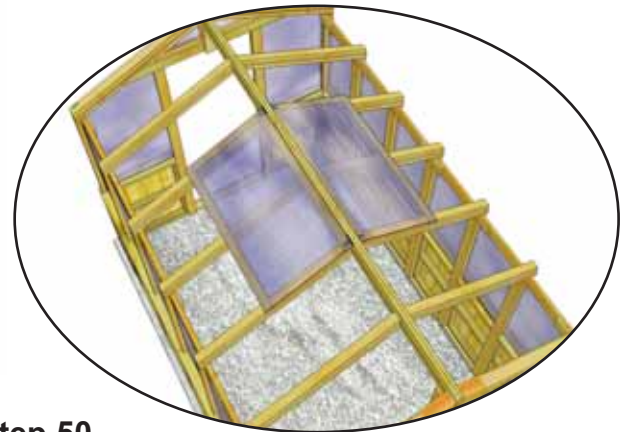
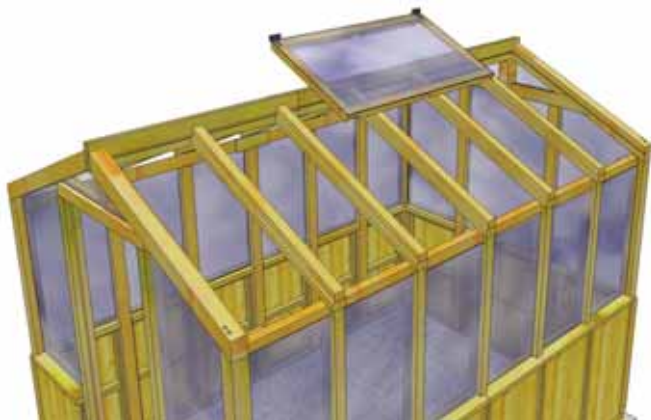

**51.** Attach second **Vent Hinged Window** as per **Step 50**.

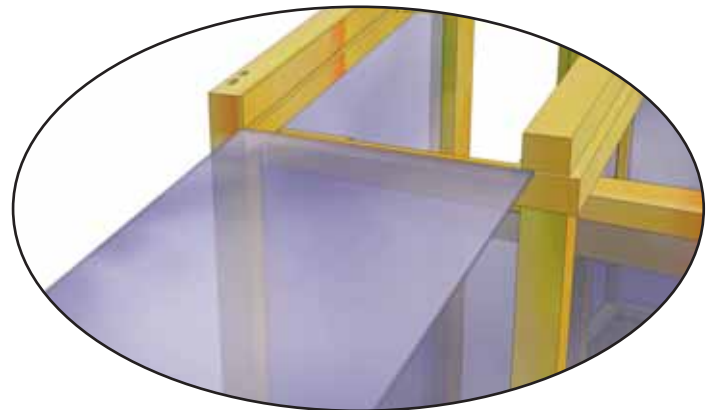
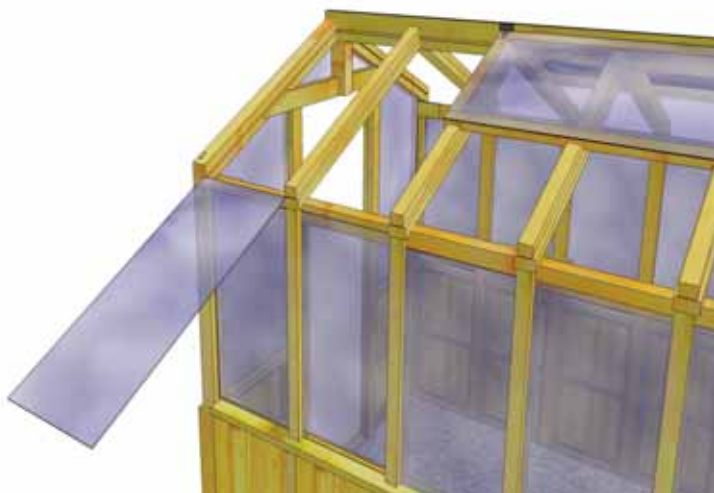

**52.** Locate **Part X - Roof Polygl Windows - 21" wide x 51" long**. Peel protective plastic layer off first sheet noting correct side out. Fit Window in dado of Outside Rafter and gap of inside Rafter as shown above.



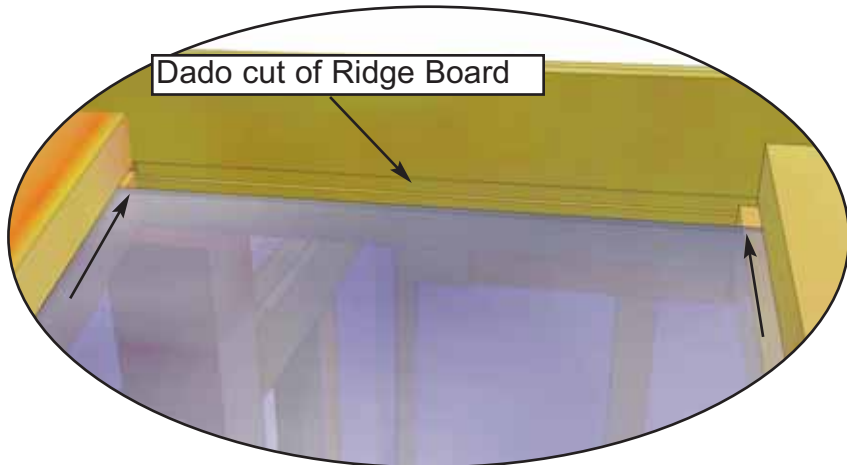
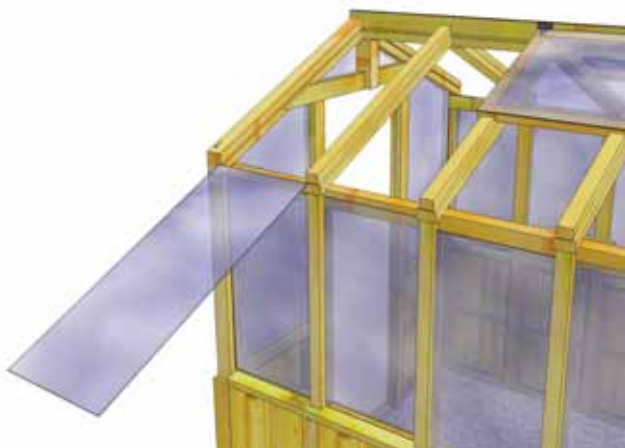

**53.** Slide Roof Window up dado cut and gap of Rafters until it slides completely into dado cut of Ridge Board.

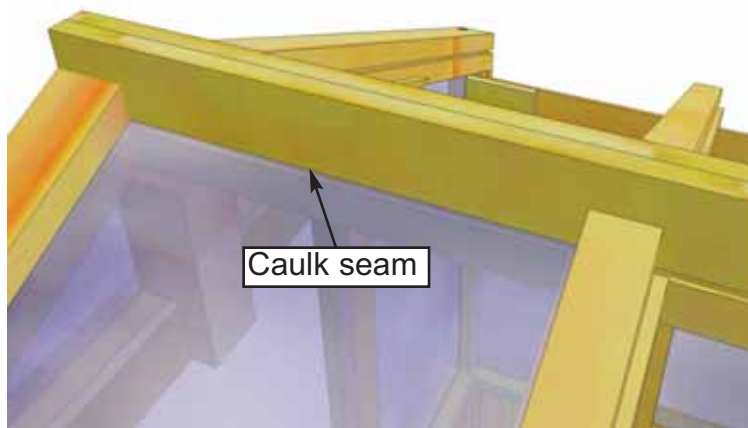

**54.** With Window in position, use 2 - 1 1/2" finishing nails to secure. Window should be slightly recessed or flush from end of Rafter and back approximately 1/4" from end of Outside Rafter. Standing on ladder from inside the Greenhouse, caulk the Ridge Board / Window Seam.

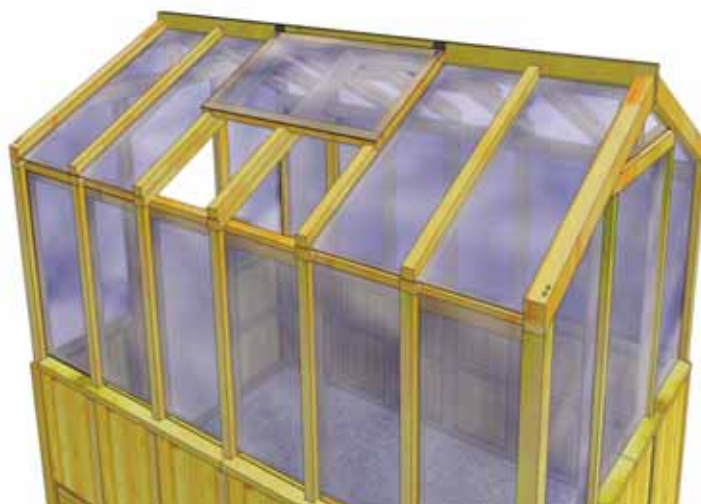
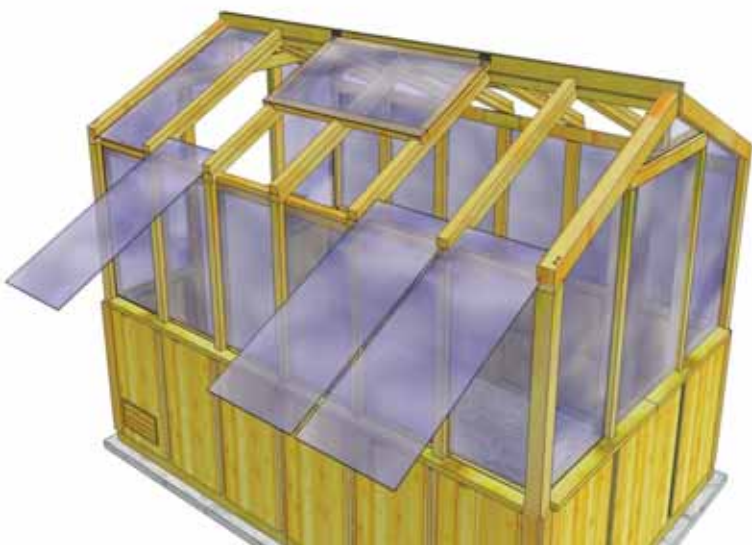

**55.** Install 3 additional Roof Polygal Windows as shown above following **Steps 52-54.**

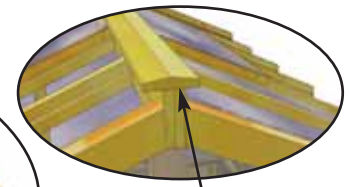
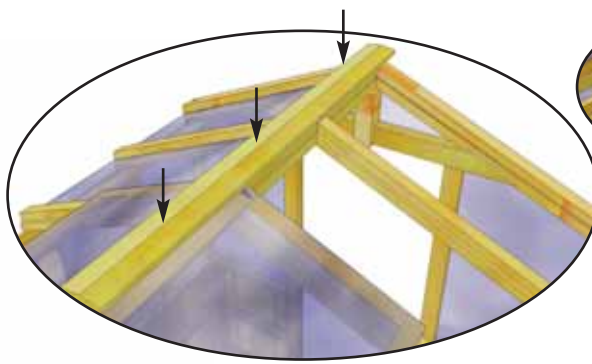
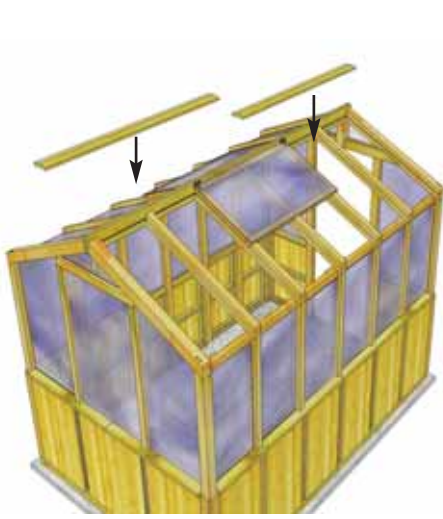

Even with end  
of Ridge Board.

**56.** Before installing remaining Roof Windows, attach **Part K - Top Ridge Caps - 1" x 5 1/2" x 70"** to top of Ridge Board. On a ladder, position 1 Cap evenly on Ridge Board and flush with the outside. Attach with 3 - 3" screws as illustrated above. Attach 2nd Cap. Work from the inside on a step ladder to attach.

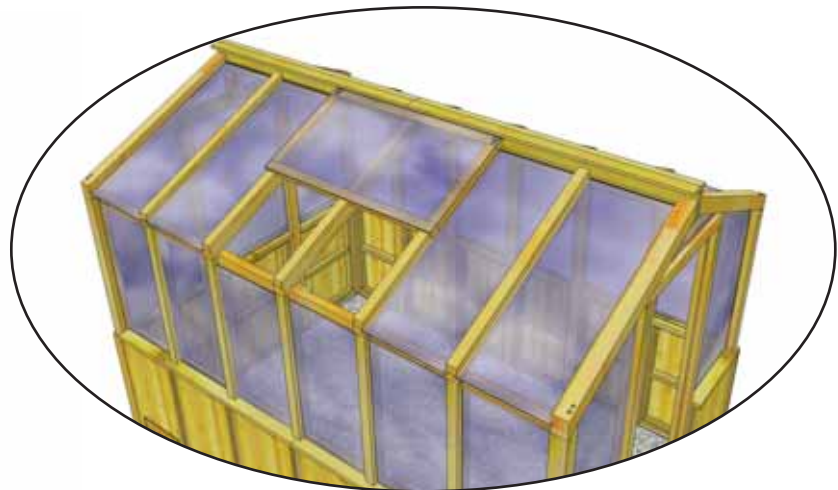
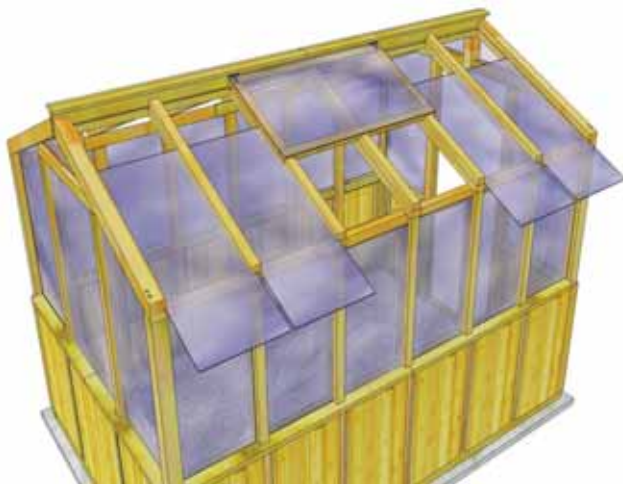
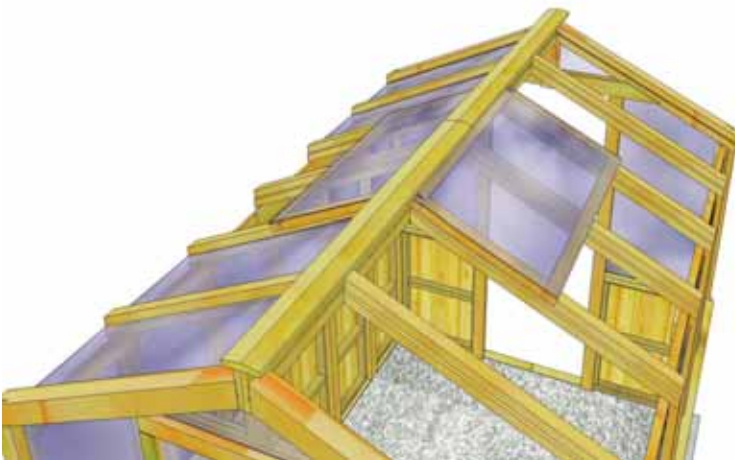

**57.** Install remaining Roof Polygal Windows as per **Steps 52-54.**

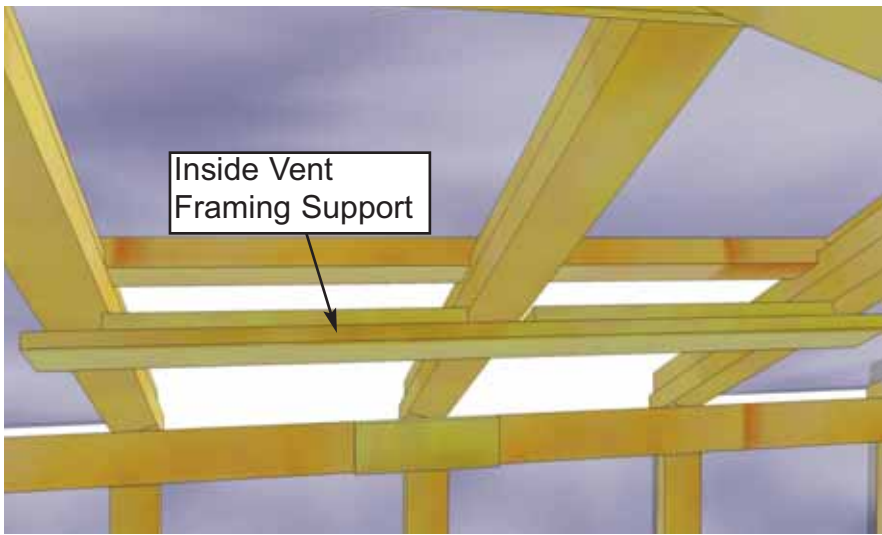

Inside Vent Framing Support



Support may need to be adjusted so hinge flange in Step 58 sits correctly.

**58.** Locate and attach **Part V - Inside Vent Framing Supports - 3/4" x 2 1/2" x 49"** with 6 - 2" screws. Position parallel with Hinged Window. Before attaching, See **Step 59** first. Position support so hinge positions correctly.

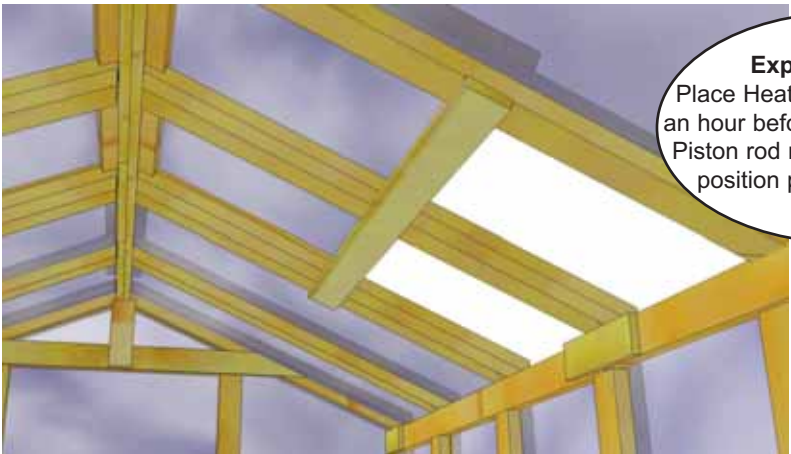

**Expert Advice**  
Place Heat Hinge in fridge for an hour before installation.  
Piston rod must be in closed position prior to installing.

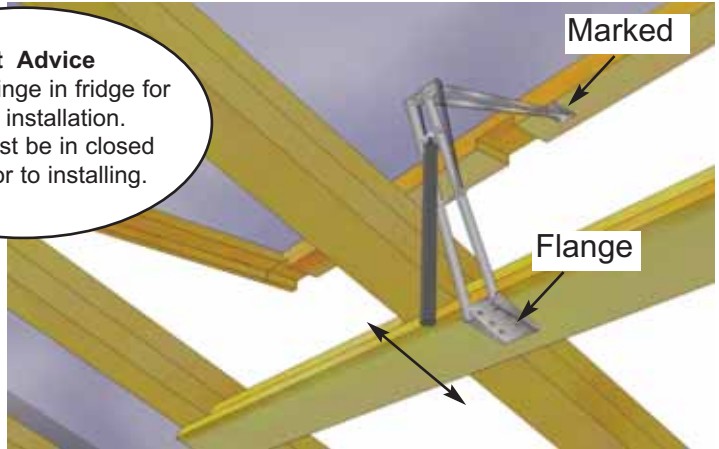

**59.** Complete both Supports. Locate both **Heat Activated Hinges. Part V** will be marked for correct location for Hinge. Heat Activated Hinge will require a basic assembly. Follow Manufacturer's directions. Attach with Manufacturer's Hardware supplied. **Phillips Head Driver will be required.**



**Important-** Heat Activated Hinges will open only after the Greenhouse reached an inside temperature of approximately 75 degrees Fahrenheit. Make sure Hinged Windows open easily and do not stick. We recommend purchasing a thermometer once the Greenhouse is complete. Please monitor Heat Activated Hinges to confirm they open and are functioning correctly. **Warning:** Extreme Cold can damage Heat Hinge, in colder climates uninstall Heat Hinge during the winter months and store somewhere at 10-15°C such as in a cool basement.

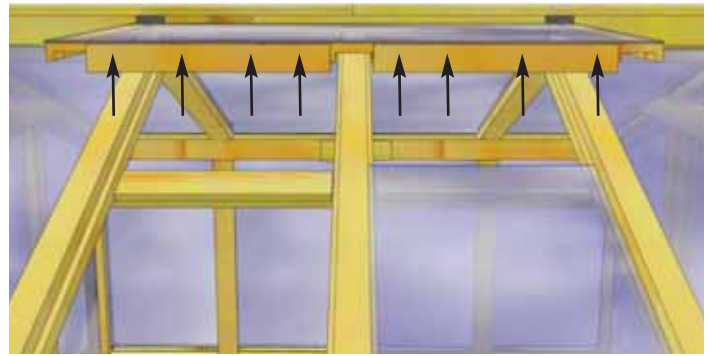
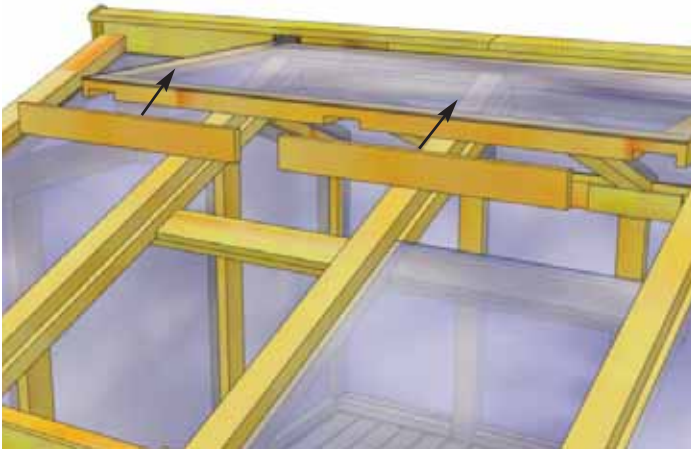

**60.** Locate **Part PP - Vent Window Trims** and **Part Y - Small Roof Polygal Windows - 21" wide x 24 1/2" long**. On your ladder, slide one small polygal panel in place then attach Vent Window Trims to front of window to cover any gaps. Bottom edge of vent window trim should rest on polygal panels when window is closed. Attach with **4 - Finishing Nails** per piece. Remove small polygal panel till **Step 61**. Complete opposite Side.

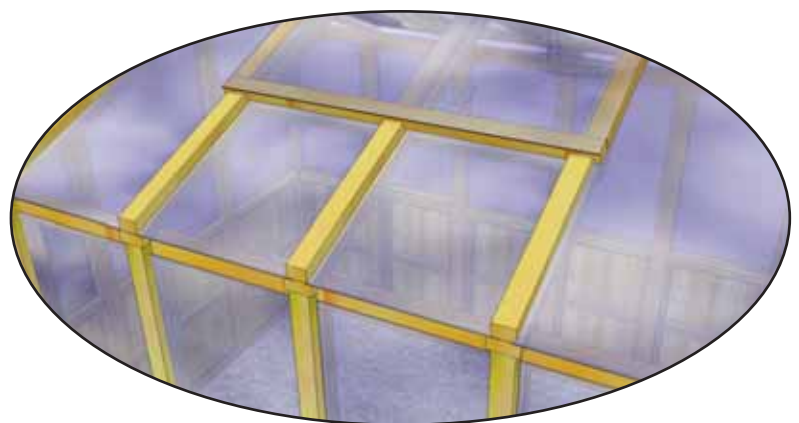
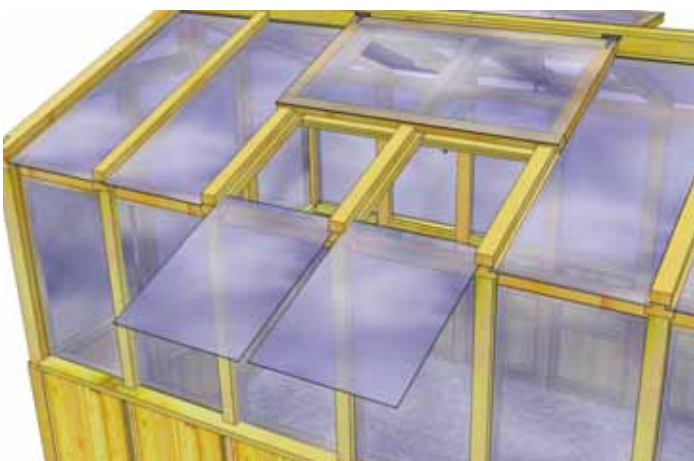

**61.** Locate **Part Y - Small Roof Polygal Windows - 21" wide x 24 1/2" long**. Peel protective plastic layer off noting correct side out. Fit Window in Rafter gaps and attach as per **Step 54**. Caulking not required. Complete all Small Roof Windows.

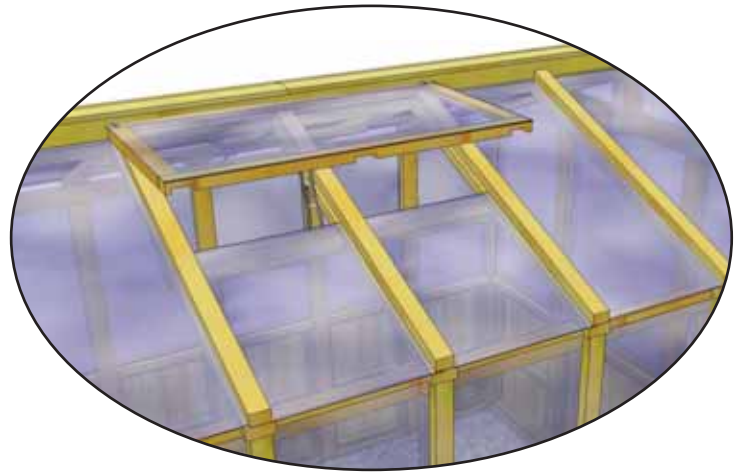
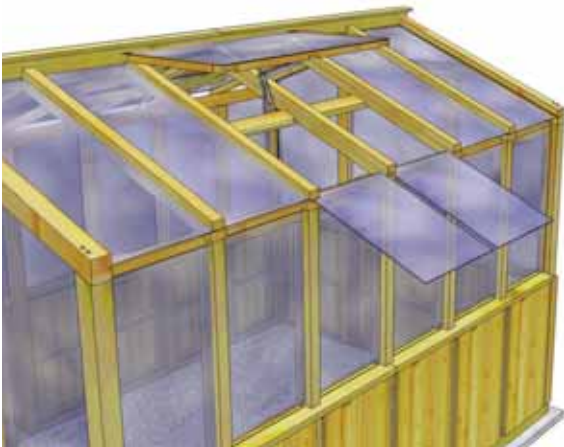

**62.** Locate **Part CC & CCC - Vertical and Horizontal Door Filler Trim - 3/4" x 2 1/2" x 33" & 87 1/4" long.** Position **3/4"** Vertical Filler Trim on Doorway Framing and attach with 6 - 1 1/2" finishing nails. There are two pieces.

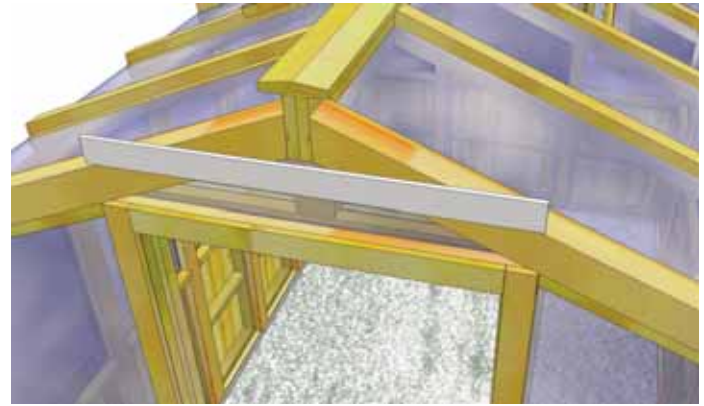
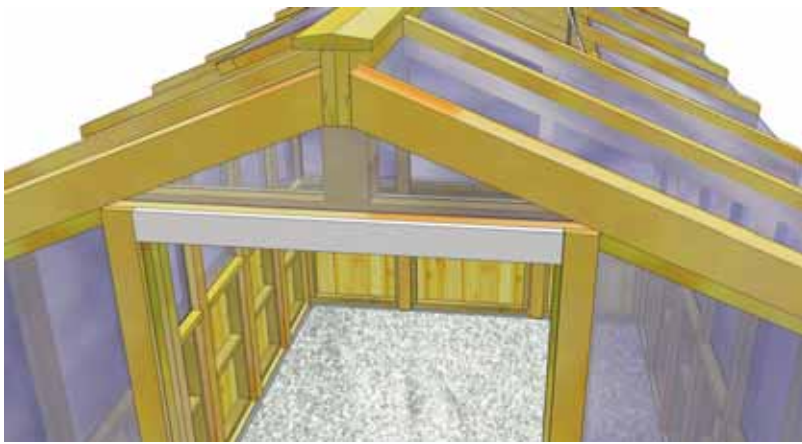

**63.** Position  $\frac{3}{4}$ " Thick Horizontal Filler Trim above Doorway and attach with 4 - 1  $\frac{1}{2}$ " finishing nails.

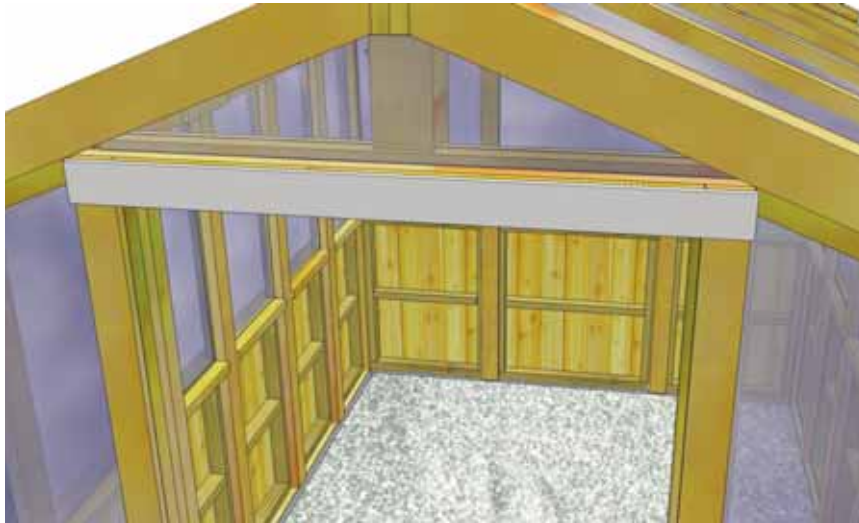

**64.** Locate **Part DD & EE - Vertical & Horizontal and Vertical Door Trim -  $\frac{1}{2}$ " x 2  $\frac{1}{2}$ " x 38"** & **84  $\frac{1}{4}$ "**. Position  $\frac{1}{2}$ " Thick Horizontal Trim over Horizontal Filler Trim and attach with 4 - 1  $\frac{1}{2}$ " finishing nails. Position  $\frac{1}{2}$ " Thick Vertical Trims over Filler Trims and attach with 6 - 1  $\frac{1}{2}$ " finishing nails per piece.

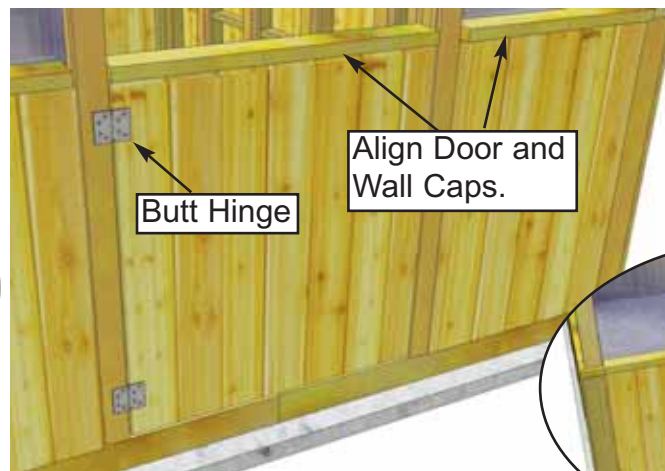

**65.** Locate **Part AA - Bottom Dutch Door - 32  $\frac{1}{2}$ " x 35  $\frac{1}{2}$ "**, **2 - Black Butt Hinges** and **12 - 2" Black Screws**. On ground, attach Hinges to Door first using 2" Black Screws. Align/shim Door and attach to Door Trim with 2" Black Screws. Confirm Door swings correctly before attaching all screws.

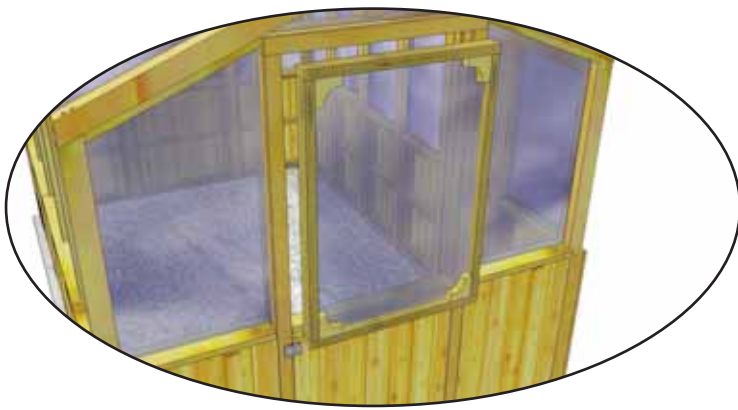

**66.** Locate **Part BB - Top Dutch Door - 32 1/2" x 47"**, **2 - Black Butt Hinges** and **12 - 2" Black Screws**. On ground, attach Hinges to Door first using 2" Black Screws. Align/shim 1/4" from Bottom Door and attach to Door Trim with 2" Black Screws. Confirm Door swings correctly before attaching all screws.

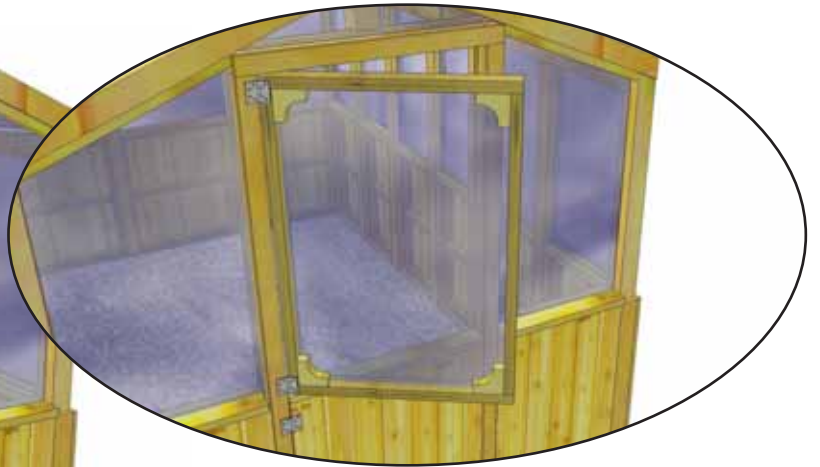

**67.** Attach **Door Handle and Exterior Black Drop Latch** to door. Handle is positioned on top door at a 30° angle with the larger end on the bottom.

Drop Latch is positioned on bottom door. Attach Black Drop Latch as illustrated to the left with 3/4" Black Screws.

Note;

Female part of Drop Latch is positioned higher than male. Do a dry run first to position Drop Latch correctly before attaching.

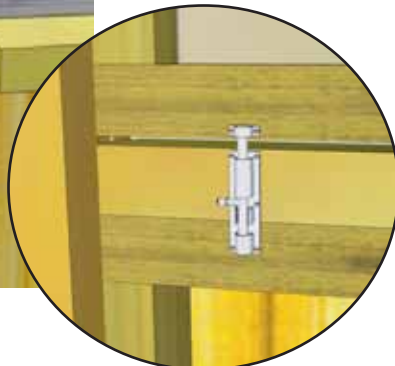

**68.** Attach **Interior Silver Barrel Bolt** to inside of door as illustrated to the left. Use 3/4" silver screws to secure. Bolt is used to connect Top and Bottom Doors.

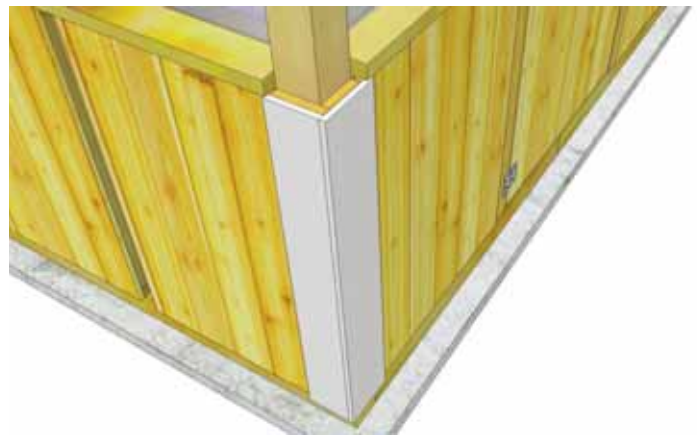
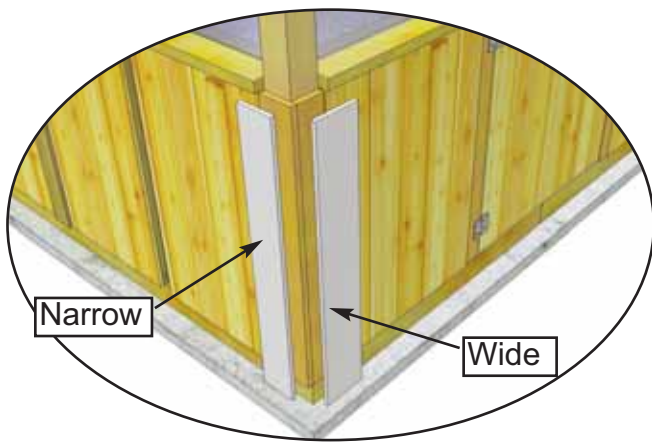

**69.** Locate **Parts FF & GG - Outside Post Trim Narrow- 1/2" x 4 1/2" x 34 7/8"** and **Outside Post Trim Wide - 1/2" x 5 1/2" x 34 7/8"**. Position with Wide Trim capping the side when looking at the front. Align Trims so flush under Wall Top Caps and attach with 4 - 1 1/4" finishing nails per piece.

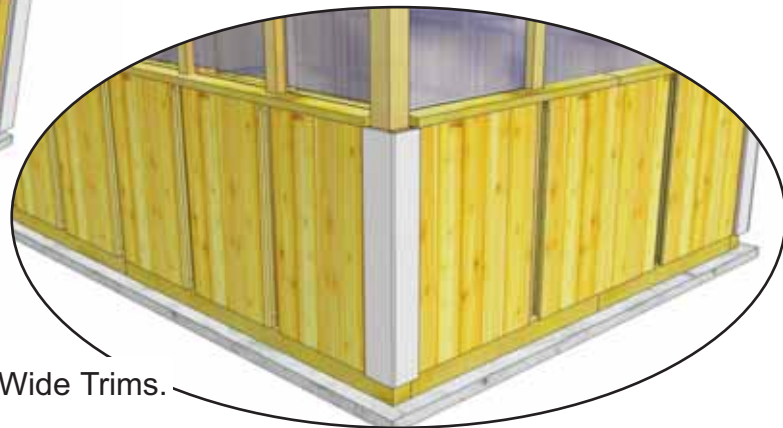

**70.** Complete remaining Outside Post Narrow and Wide Trims.



**71.** Locate **Part HH -Vertical Wall Trim - 1/2" x 3 1/2" x 34 7/8"**. Position underneath Top Wall Cap where Walls attach to Posts. Center and attach with 4 - 1 1/2" finishing nails per piece.



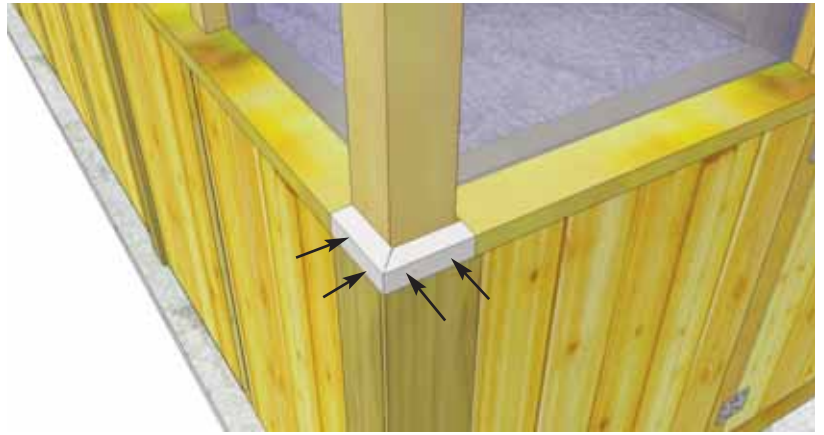
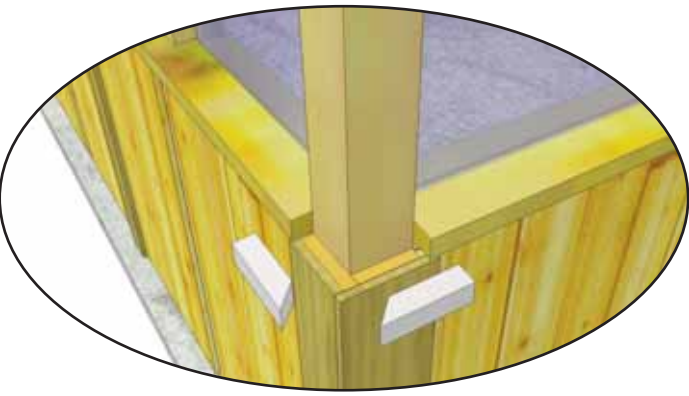

**72.** Locate **Part II - Corner Post Trim - 1 3/8" x 1 1/2" x 4 7/8"**. Position around each Outside Corner Post. Attach with 2 - 2" finishing nails per piece.

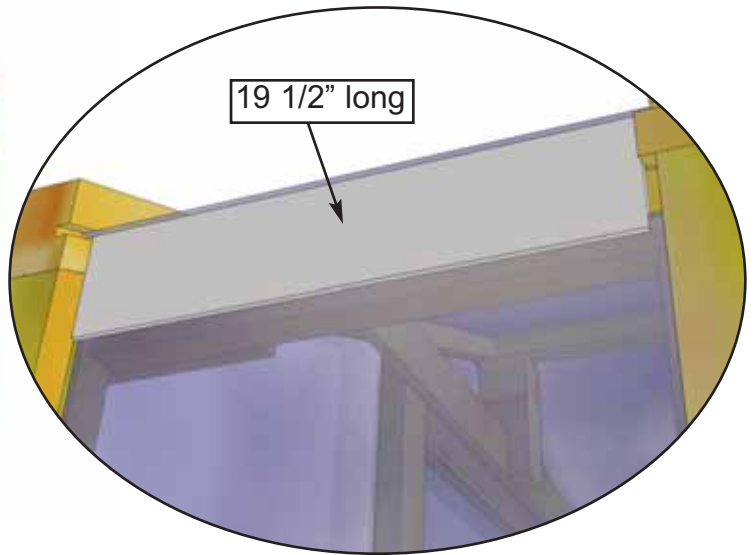

**73.** Locate **Part LL - Side Soffits - 1/2" x 4" x 19 1/2"(4) & 19 1/8"(8)**. Position underneath Roof Window and between Outside and Side Post. Orientate Soffit with rough face out and lap siding down and to the inside to cap Side Window. Attach with 4 - 1 1/2" nails. Finish all corner Soffits now.

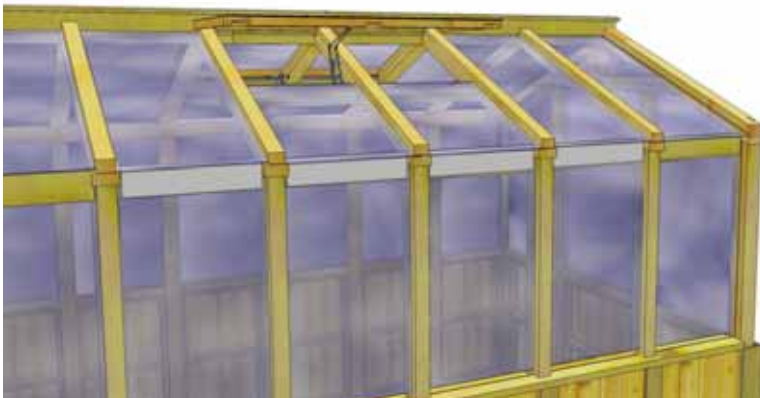

**74.** Position 19 1/8" Soffits underneath remaining Roof Window and attach as per **Step 73**.

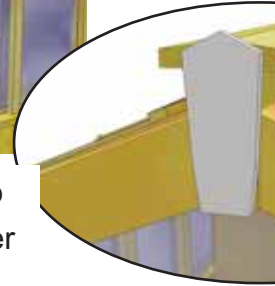
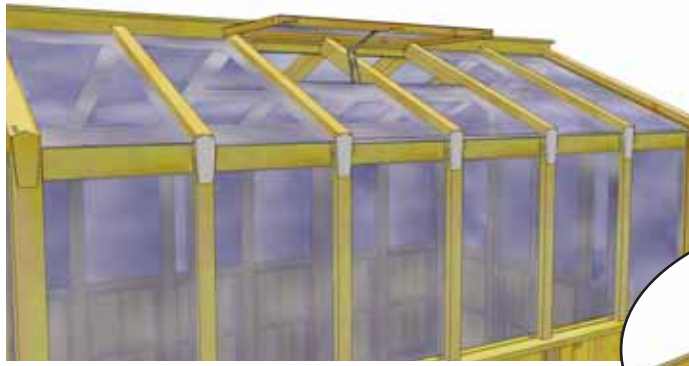
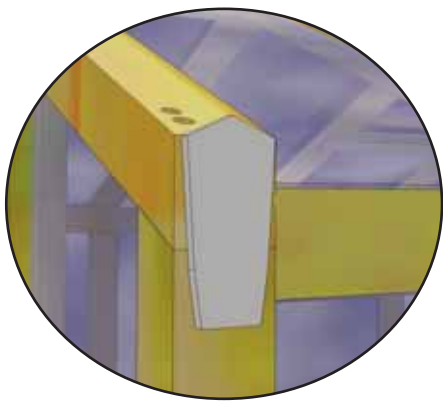

**75.** Locate **Part JJ - Detail Caps - 1/2" x 3 1/2" x 10"**. Position to cover Post and Rafter connection. Attach with 4 - 2" finishing nails per piece. In the Front and Rear, attach Cap to cover Rafter/Ridge Board connection. Attach with 4 - 1 1/2" finishing nails.

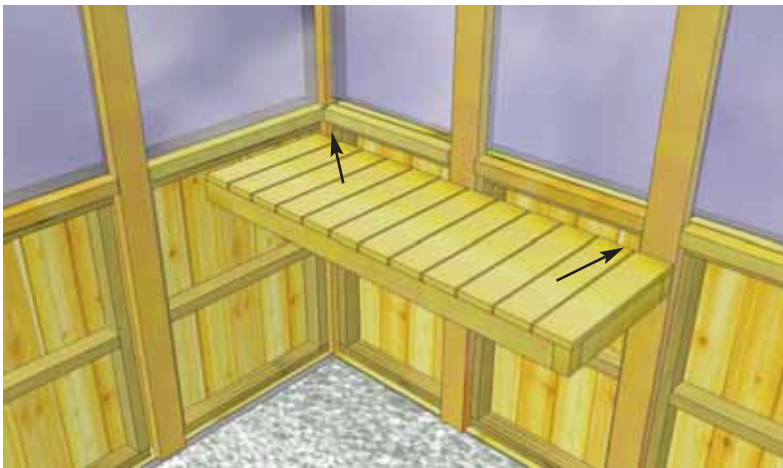

**76.** Locate **Parts MM and NN - Potting Shelves - 16" x 45 3/8"** and **Potting Shelf Supports - 1 1/2" x 2 1/2" x 20 1/2"**. With helper holding Shelf just under the Top Wall Cap, screw to wall from underneath with 3 - 3" screws as shown above.

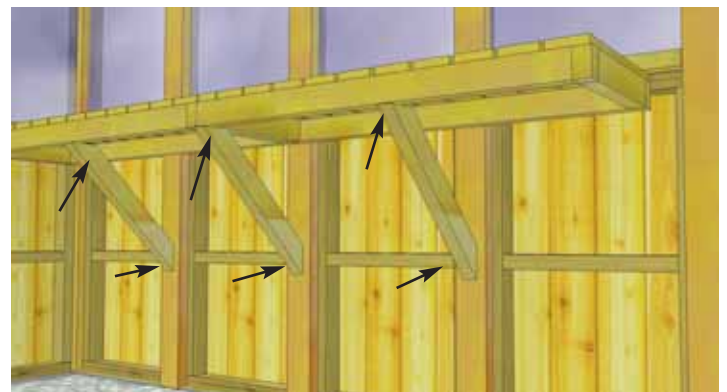

**77.** Position Potting Shelf Support against Post and under Shelf framing. Level Shelf and attach Support with 2 - 3" screws. Complete Shelving and Supports for side.



**78.** Complete all Shelving and Supports!



**Note:** Our Greenhouse is shipped as an unfinished product. If exposed to the elements, the western red cedar lumber will weather to a silvery-gray color. If you prefer to keep the cedar lumber looking closer to the original color, we suggest that you treat the wood with a good oil base wood stain. You may also wish to paint rather than stain. In both cases we recommend that you consult with a paint and stain dealer in your area for their recommendations.



**Completed 8x12 Greenhouse**

We hope your experience assembling your Greenhouse has been both positive and rewarding.

We value your feedback and would like to hear back from you on how well we are doing in the following areas:

- 1. Customer Service**
- 2. On Time Shipping**
- 3. Motor Freight Delivery**
- 4. Quality of Materials**
- 5. Assembly Manual**
- 6. Overall Satisfaction.**

Please call, write or email us at:

Outdoor Living Today

Canadian Address  
 9393 287th Street  
 Maple Ridge, British Columbia  
 Canada V2W 1L1

United States Address  
 P.O. Box 96  
 Sumas, Washington  
 USA 98295



The materials contained in this Assembly Manual may be downloaded or copied provided that ALL copies retain the copyright and any other proprietary notices contained on the materials. No material may be modified, edited or taken out of context such that its use creates a false or misleading statement or impression as to the positions, statements or actions.